



QC-POWER-3PC MULTIFUNCTION METER

GENERAL

The digital multimeters **QC-POWER-3PC** allow monitoring the main electrical parameters present on a distribution line. The local display of the various electrical parameters is carried out by 3 displays with red LED, granting a good and simultaneous reading of various values. A simple front panel completes the intuitive selection of several electrical parameters, in order to provide full information.

On top of the instantaneous measures, these instruments display the maximums (peak of the main parameters and maximum demand or average maximum value).

The multifunction meters **QC-POWER-3PC** replace in a unique device, all the functions of voltmeters, ammeters, energy meters, cosphimeters, wattmeter's, varmeters, hour meters and frequency meters. This gives a great economic saving, by reducing space and time, optimising also the purchase management of instruments, since one model meets most demanding requirements for local measuring in electrical boards, switch-boards, MCC's, Gen-sets, etc.

INTRODUCTION

The QC-POWER-3PC has a RS485 port. The auxiliary supply is connected to 2 terminals, separated from the measuring voltage inputs. It is necessary to use of external CT's for measuring the currents.

ACCESSORIES AND OPTIONS

Accessori: Din rail mounting CT's

Opzioni: Auxiliary supply and measuring voltages, other than standard (under request)

Current Input 1A

MEASURED PARAMETERS

Parameters	Measuring units	Identification symbols			
phase and three phase voltage	[V]	V L1-N	V L2-N	V L3-N	Σ V L-N
phase to phase and three phase system voltages	[V]	V L1-L2	V L2-L3	V L3-L1	Σ V L-L
phase and three phase currents	[A]	I L1	I L2	I L3	Σ I
phase and three phase power factors		PF L1	PF L2	PF L3	Σ PF
phase and three phase active powers	[kW]	W L1	W L2	W L3	Σ W
phase and three phase system reactive powers	[kVAr]	VAr L1	VAr L2	VAr L3	Σ VAr
phase and three-phase system apparent powers	[kVA]	VA L1	VA L2	VA L3	Σ VA
three phase average powers	[KW - kVAr - kVA]	Σ W (avg)	Σ VAr (avg)	Σ VA (avg)	
three phase forecasted average powers	[KW - kVAr - kVA]	Σ W pr (avg)	Σ VAr pr (avg)	Σ VA pr (avg)	
frequency	[Hz]	Hz L1			
phase and three phase active energy	[kWh]	Σ kWh L1	Σ kWh L2	Σ kWh L3	Σ kWh
phase and three phase reactive energy	[kVArh]	Σ kVArh L1	Σ kVArh L2	Σ kVArh L3	Σ kVArh
hour meter	[h]	h			
Peak value (maximums)					
phase voltage	[V]	V L1-N max	V L2-N max	V L3-N max	
phase currente	[A]	I L1 max	I L2 max	I L3 max	
phase average current (maximum demand)	[A]	I L1 max (avg)	I L2 max (avg)	I L3 max (avg)	
three phase system powers	[KW - kVAr - kVA]	Σ W max	Σ VAr max	Σ VA max	
three phase system average power (max demand)	[KW - kVAr - kVA]	Σ W max (avg)	Σ VAr max (avg)	Σ VA max (avg)	



INSTALLATION

WARNINGS FOR THE USER

Read carefully the instructions/indications contained in this manual before installing and using the instrument. The instrument described in this manual is intended for use by properly trained staff only.

SAFETY

This instrument has been manufactured and tested in compliance with EN 61010-1 (IEC1010) standards. In order to maintain these conditions and to ensure safe operation, the person must comply with the indications and markings contained in the manual. When the instrument is received, before beginning installation, check that it's OK and it has not suffered any damage during transport. When starting installations make sure that the operating voltage and mains voltages are compatible with the device instructions. The instrument power supply must not be earthen. Only qualified and authorised personnel must carry out maintenance and/or repair. If there is ever the suspicious that, that there is a lack of safety, during operation, the instrument must be disconnected and cautions taken against accidental use.

Operation is no longer safe when: The instrument doesn't work. - There is clearly visible damage. - After serious damage occurred during transport. - After a storage under unfavourable conditions.

The fixing to the DIN rail is granted by the rear spring fixing device.

It's better to put an external protection with fuses for the voltage inputs and to use adapted cables for the working currents and voltages: section from 0.5 to 4 mm².

CONNECTION

For a correct use of the device, the wiring diagram contained in the present manual must be respected.

The connections are available on the screw terminals:

- Power supply:

The auxiliary power supply is taken from the terminals aux1 and aux2.

The rated supply voltages can be:

standard:	Vn 230V	± 15%	50-60Hz
under request:	Vn 110V	± 15%	50-60Hz
under request:	Vn 400V	± 15%	50-60Hz

- Measuring voltage inputs:

4 terminals are available for wiring to the 3 phase and neutral of the measuring network, the maximum voltage phase to phase shouldn't be over 500V rms and 290V between phase and neutral.

In case of a 3-phase system without neutral or non-distributed neutral, leave terminal N free.

For single phase use, wiring should be done between terminals L1 and N and bridge L2 and L3 phases to neutral N.

- Measuring current inputs:

6 terminals are available for wiring to 3 external CT's with secondary 5A, it's possible to use 2 CT's on 3 wires lines with (Aron three-phase wiring) and the use of 1 CT in case of single phase system (input IL1). External CT's must always be used.

The instrument's SETUP menu allows to set the transformation rate of the external CT and it's possible to visualise readings of current up 999 A. Should the case be that calculated current is higher than the maximum value, the display will show the over range condition. The maximum setting of the transformation ratio is 2000/5=400.

NOTE:

For a correct measuring of the power factor and energies and powers it's a must to respect the phase sequence. The connections between current and voltage phase inputs must not be inverted (for example, CT placed on phase L1 must correspond to the I1 input). So as it is not correct to invert S1 and S2 of the CT's terminals. The earthing of the CT's secondary should be made using the wires connected to the C.I. terminal.

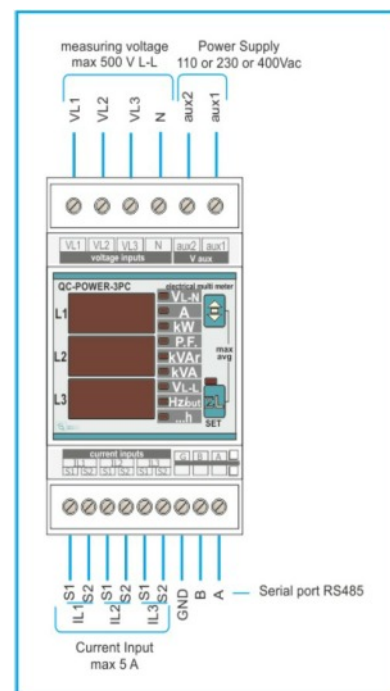



WIRING DIAGRAMS

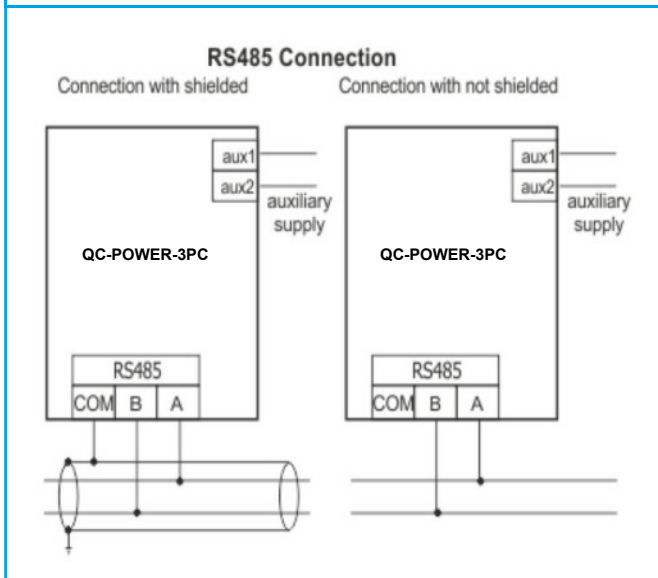
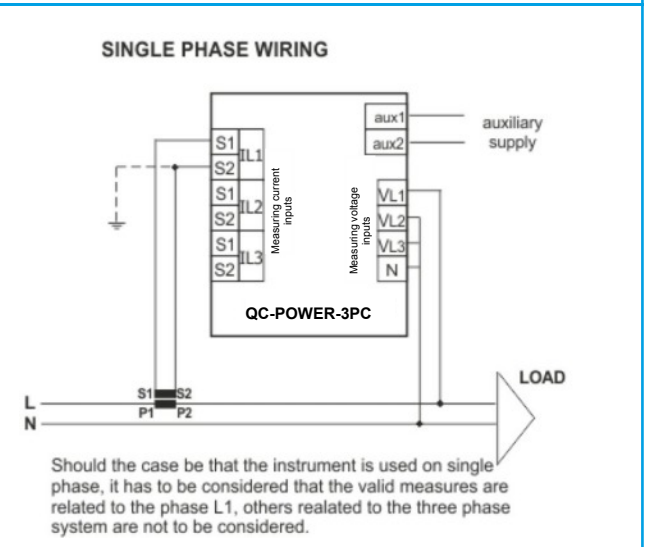
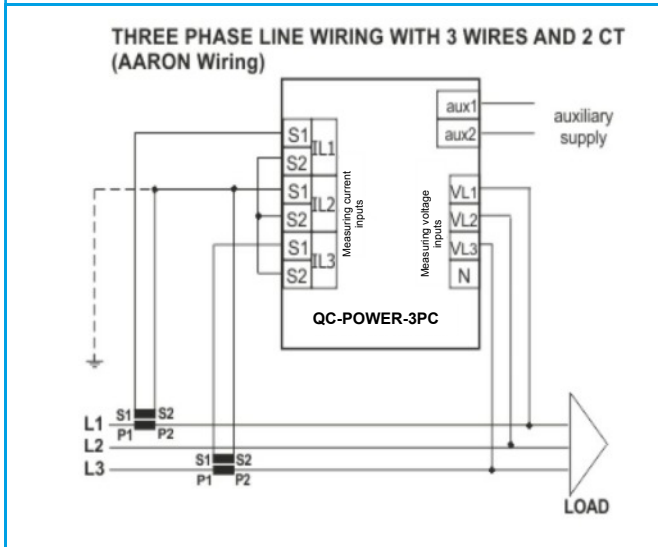
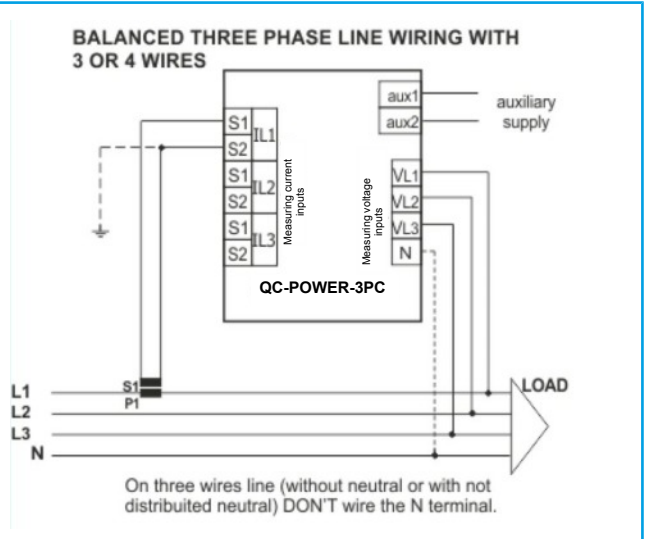
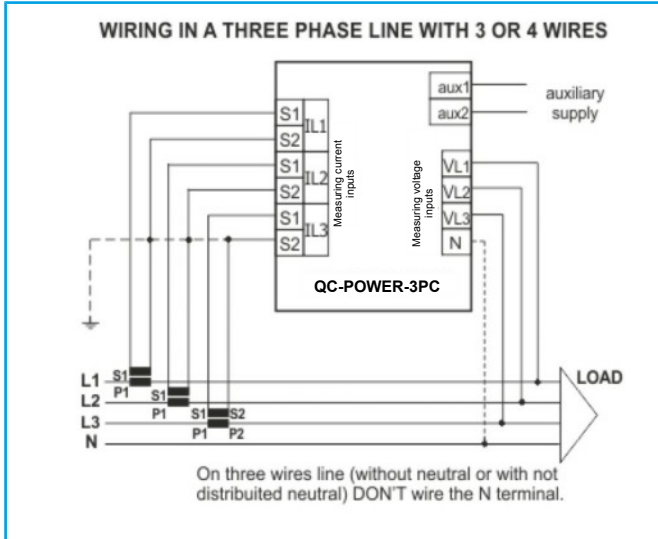

DESCRIPTION

LEGEND:

- A:** key for visualising the three phase system parameters with its corresponding **LED**. By pressing again this key, the instrument returns to reading each individual phase. By keeping the key pressed for 5 seconds the instrument reaches the programming mode (**SETUP**). In **SETUP** mode, this key confirms the values set and by pressing the **B** key simultaneously, it starts decreasing the value.
- B:** key for selecting the measured parameters to be shown at the **C** display. In **SETUP** mode selects and modifies the value of the parameters to be set.
- A+B:** with the simultaneous pressing of both keys the instrument reaches the visualisation of the maximum and average values, which may be selected with the **B** key. To escape from maximum and average values visualisation, don't press any key for 8 seconds.
- C:** three displays for visualising the measures, subdivided by phase of the parameters indicated by the LED **D** bar. In case that the ΣL LED (**G**) is glowing, the instruments shows the three phase values of the measures, indicated by the LED **D** bar.
- D:** LED bar for indicating the measures visualised on display **C**.
- E:** terminals for wiring the voltage measures input and auxiliary supply.
- F:** terminals for wiring the current measures input and the digital output (when present in the instrument).
- G:** LED for indicating of a three phase value visualisation.

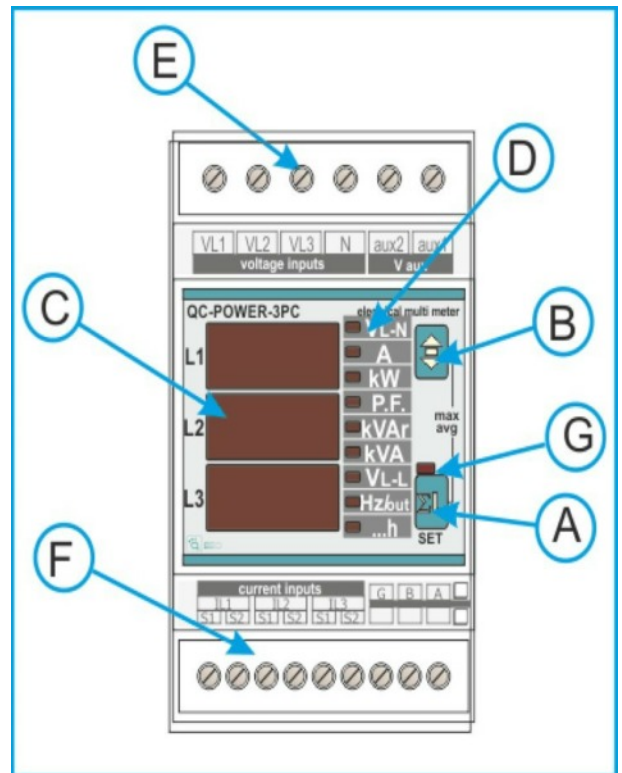

MENU FOR PROGRAMMING THE INSTRUMENT (SETUP)

The instrument's **SETUP** menu is reached by pressing the **A** key during 3 seconds. Once in the **SETUP** menu, it is possible to select or modify the visualised parameter's value, by pressing the **B** key. If no pressing is made on any key during 8 seconds, the instrument escapes from the **SETUP** menu.

For a correct operation of the multimeters the instrument has to be programmed with the transformation ratio of the external CT's.

It will only be possible to reset the energy meters in those instruments fitted with such a characteristic, so as to program the digital outputs only if the digital outputs is available in the instruments.

The set values are kept without auxiliary supply even.



> 5 seconds, access to the programming menu (**SETUP**)



for selecting of a parameter or modifying the parameter's value for programming (**SELECT**)



for confirming the selection or confirming the programmed parameter's value (**ENTER**)



CONFIGURATION OF GENERAL PARAMETERS (SET UP)

Entry to menù



seT Up



seT Up
RESET
SET HR_



SET CT
Set CT ratio
from 1 to 400 (/5A)
from 1 to 2000 (/1A)



Increase



Decrease



SET VT
Set VT ratio
from 0.1 to 400.0



Increase



Decrease



seT AV9 T
Set avarage time
from 1 to 30 minutes



Increase



Decrease



seT 3pH
Set connection type



BALANC
UN_BAL
1PH L1



seT MDE
Set wiring connection
type



-3-

-4-



seT SYN MDE
Set synchronism
type



L1

50

60



seT ID ADR
Set address of netwok
from 001 to 247



Increase



Decrease

Set baud rate
serial interface



seT SER BDR
19200 baud
9600 baud
4800 baud
2400 baud



19.2

9.60

4.80

2.40

Set parameters of
communication
serial interface



SeT PAR
bit: 8data 1 stop-no parity
bit: 8data 2 stop-no parity
bit: 8data 1 stop-even parity
bit: 8data 1 stop-odd parity



8.1 paR NO

8.2 paR NO

8.1 paR EVE

8.1 paR ODD



SET PAS
Set Password
OFF - 0002 ÷ 9999



Increase



Decrease



Confirm and end of general settings



Programming the transformation ratio of the external CT's (SET CT)

The programming of the CT's ratio is considered as the rate between the primary and the secondary (i.e.: with CT 1000/5, we must set 200 as value). The setting will be done with the push-button on the front panel.

Some seconds after giving the auxiliary supply to the instrument (during the switching on, all LED and displays will flash alternatively to the firmware indication), by pressing the **A** key, the display **C** will show the message **seT Up**.

Then press **A** again to reach the programming menu and the **C** display will show the message **seT CT** and the value of the transformation ratio (set as 1 by the manufacturer) will appear at the third display. Press the **B** key to increase the value or press simultaneously the **A** key to decrease the value (the variation is performed unit per unit). To speed up the operation, keep on pressing the button **A** and **B**, and the variation will appear successively by tens and hundreds, releasing and pressing the key again it will return to increase or decrease the value at unit per unit. Press the **A** key to confirm, the instrument will pass to successive programming menu. Shouldn't any key be pressed during a 10 seconds interval of time, the instrument will exit automatically from programming without saving the set values.

Programming of the transformation ratio of the external voltage transformers (SET VT)

After the precedent programming phase, on **E** display will appear the inscription **VT** (voltage transformer) and the value of the transformation rate of the external TV (set to 1 from the constructor), considered as the rate between primary and secondary (example with TV 15/0.1 kV the value will be 150).

In the same way at the programming of the CT rate will be possible to set this value. If the external TV are not used the value to set will be 1. To confirm the value press the **A** button.

Programming of the average time (seT AVG T')

After the programming phase previously described, pressing another time the **A** key, on the **C** display will appear the message **AVG T'** and the average time settable from 1 to 30 minutes.

To increase the value press the **B** key. To decrease it, press the **A** key with **B** key already pressed. To confirm it press the **A** key. The average time is the time used to calculate the average parameters (**avg**) and the maximum demand (**maxD**).

Programming insertion mode (3PH)

In a unbalance three phase system it's necessary to set **UN_BAL** (unbalance) while in a balance system (only one CT and only one VT) the correct set is **BALANC** (balance). For a single phase insertion it's necessary to set **1PH L1**.

Programming wiring connection mode (MDE)

This setting allows to definite the wiring type connection. It's possible to chose 3 wires or 4 wires. With the 4 wires connection the neutral parameter are displayed and enabled to use for the digital outputs settings.

Programming of the synchronism type (SYN MDE)

In this setting for the synchronization type, it's possible to choose L1 to use the external frequency (on L1 phase) or **50, 60** Hz to use the internal clock.

Programming of the address for the communication network (SET ID ADR)

After the confirm with the **A** key of the previous value, the message **ID aDR** will appear on **C** display; to set the value that will identify the instrument when it will be connected in a EIA485 communication network, proceed with the modality, already described. The settable values are from 1 to 247. To confirm, press the **A** key.

Programming of the baud rate (SET BDR)

The following setting is the baud rate. The message **SET BDR** on the first two parts of **C** display to indicate the programming of the baud rate displayed on the third part (L3) of the **C** display. To modify the value set, it's necessary to use the **B** key. The values settable are: **19.2**=> 19200 baud, **9.60**=>9600 baud, **4.80** =>4800 baud, **2.40**=>2400 baud. Press **A** to confirm the value displayed.

Programming of the serial parameters

The following message will appear on **C** display using the **B** key. To confirm press the **A** key.

8 1	8 data bit / 1 stop bit	8 2	8 data bit / 2 stop bit	8 1	8 data bit / 1 stop bit	8 1	8 data bit / 1 stop bit
PAR	No parity	PAR	No parity	PAR	Even parity	PAR	Odd parity
NO		NO		EVE		ODD	

Programming of the Password (SET PAS)

The instrument is supplied without password. When a password (from 0002 to 9999) is set, using the **B** (to increase), **A-B** together (to decrease) and **A** (to confirm) keys, only who know this value can to enter in the setup. The password, in fact, is required all the time that someone try to enter in the setup (pressing the **A** key for more of 3 seconds). If the password is wrong, the message **PASS ERR** will appear on **C** display and the instrument go back to the measures visualization. To input the password, when required by the instrument, at the enter of the setup, use the **A** and **B** keys as the same way done previously.



CANCELLING OF THE PEAK VALUES AND ENERGY METERS (RESET)

From the measures visualisation mode, keep the **A** key pressed until the message **seT UP** appears on the **C** display; then press the **B** key until the message **RES ET** appears on the **C** display; access to the reset menu by pressing the **A** key. By pressing the same key we can now select the cancellation type that we wish to activate.

Here below the different types:

RESET PEA cancellation of the instantaneous values only

RESET 15' cancellation of the average values in the 15' only

RESET EN cancellation of the energy meters

RESET All cancellation of the energy meters, average and the instantaneous values.

To activate the selected cancellation mode, press the **B** key to change the **C** display's indication from **NO** to **yes**. Confirm to activate the cancellation, by pressing the **A** key; the indication in the display **C** will pass from **yes** to **---**. Without pressing any key, wait until the instrument returns to the measures visualisation mode.

MEASURES VISUALISATION

According with the glowing status of the **G** LED the reading of the measures is visualised on display **C**, **either the three measures of the phase values or the three phase measured values** (average of the individual phases for voltage, current, power factor and the sum of the individual phases for powers).

With the **G** LED off, the instrument will visualise the **three measures of phase** (L1, L2 and L3 respectively) of the parameter indicated by the light of the LED **D**. for the phase to phase measures (V L-L), the three measures are understood V L1-L2, V L2-L3, V L3-L1 respectively.

By pressing the **B** key, you may select the parameters to visualise, which will be indicated by the LED **D**.

The visualisation of the frequency page shows also the status of the digital output (if present).

By pressing the **A** key with the **G** LED on, the instrument will visualise the selected parameters in **three phase values** (average of the individual phases for voltage, current, power factor and the sum of the individual phases for powers).

In this mode, each page will show the measures of 3 parameters, indicated by the LED **D**, excluding the frequency pages, the energy meters and the hour meters.

The visualising of the energy meters is only possible with the **G** LED on.

If the hour meter is available, is visualised: as hour meter per phase, activated by the three phase current, after the visualisation of energies in those types fitted with energy meters.

By pressing the same key again, the instrument returns to the visualisation of the phase parameters.

Should the single phase system wiring been made, the visualisation of the values will be shown in the same way as per the three phase measures, indicating three parameters on each page. In the present case the LED **G** will never glow, since it isn't a three phase system.

VISUALISATION OF ENERGY AND HOUR METERS

The visualisation of the energy meters are shown with the lighting of the LED **kWh + ...h** indicating the active energy values (kWh), whilst the lighting of the LED **kVar + ...h** are indicating the reactive energy values (kVarh).

The lighting of the LED **h** alone, identifies the reading of the hour meter.

The reading of the meters uses the 9 digits (maximum reading 99999999.9) of the display **C**: the measure comes visualised in such a way that, the display L1 will show the first 3 digits, the display L2 the second 3 digits and the display L3 the last 3. For example if: L1=000, L2=028, L3=53.2, the reading is equal to 00002853.2 kWh.

In the case of the hour meter, it uses only 6 digits (maximum reading 99999,9) of the display **C**: the measure comes visualised in such a way that, the display L2 will show the first 3 digits, and the display L3 the last 3 digits.

For example if: L2=008, L3=53.2 the reading is equal to 00853.2 h.

NOTE ON THE VISUALISATION OF THE PARAMETERS

The visualisation of a capacitive power factor value comes represented by a **-** sign before the first digit of the display (example of reading: **-.95** indicates a capacitive power factor of **0.95**).

The visualisation of a negative active power (inverted connection of the CT's or cogeneration presence) comes represented by a **-** sign before the first digit of the display.



VISUALIZATION OF THE PHASE VALUES (for three-phase connection)
(connection mode set to **BALANC** or **UN_BAL**)

Visualization page 1
VL1-N on L1 = 232 V
VL2-N on L2 = 230 V
VL3-N on L3 = 229 V

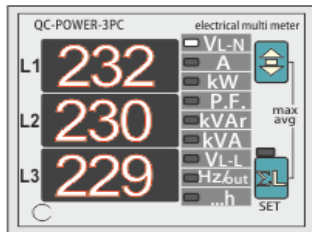

Visualization page 2
IL1-N on L1 = 28,2 A
IL2-N on L2 = 9,2 A
IL3-N on L3 = 35,7 A

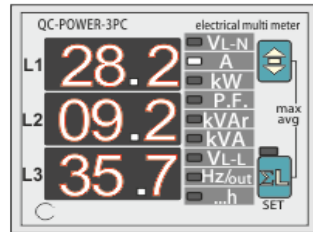

Visualization page 3
PL1 on L1 = 562 kW
PL2 on L2 = 184 kW
PL3 on L3 = 99,2 kW

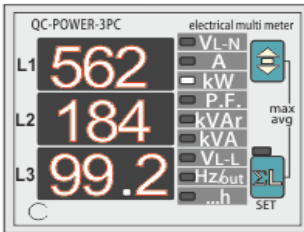

Visualization page 4
PF on L1 = 0,93
PF on L2 = 0,92
PF on L3 = 0,90

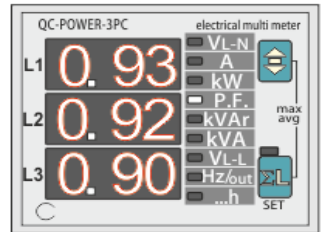

Visualization page 5
QL1 on L1 = 562 kVAR
QL2 on L2 = 184 kVAR
QL3 on L3 = 99,2 kVAR

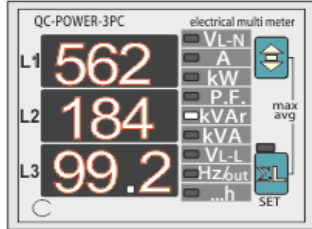

Visualization page 6
SL1 on L1 = 562 kVA
SL2 on L2 = 184 kVA
SL3 on L3 = 99,2 VA

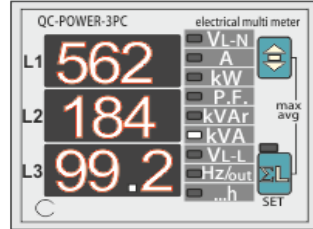

Visualization page 7
VL1-L2 = 401 V
VL2-L3 = 403 V
VL1-L3 = 399 V

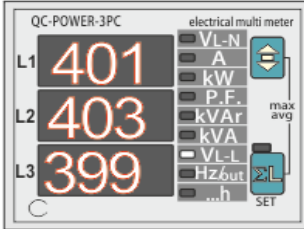

Visualization page 8
F su L1 = 49,9 Hz
Out = ON
Dig. Out = Alarm

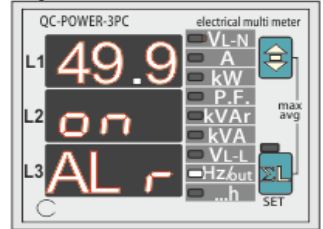

Visualization page 9.1
Active energy counted
L1 phase
232,8 kWh

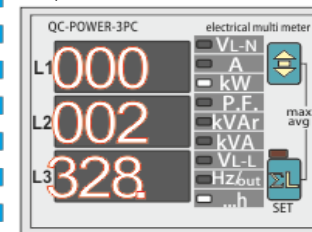

Visualization page 9.2
Phase of energy counted
L1 phase

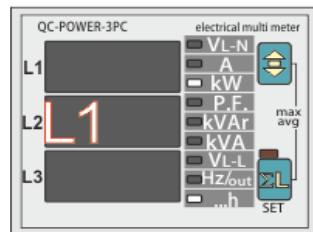

Visualization page 10.1
Active energy counted
L2 phase
232,8 kWh

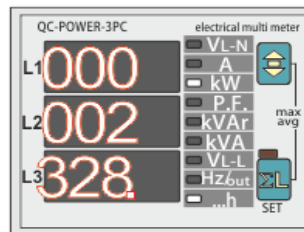

Visualization page 10.2
Phase of energy counted
L2 phase

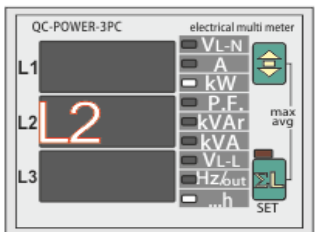

Visualization page 11.1
Active energy counted
L3 phase
232,8 kWh

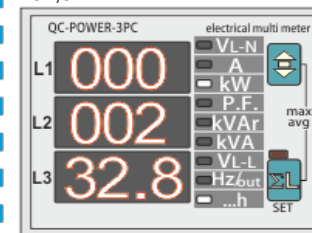

Visualization page 11.2
Phase of energy counted
L3 phase

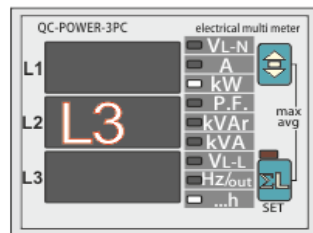

Visualization page 12.1
Reactive energy counted
L1 phase
232,8 kWh

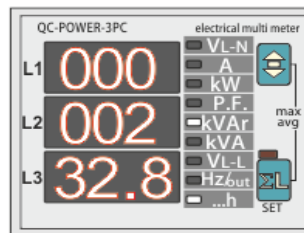

Visualization page 12.2
Phase of energy counted
L1 phase

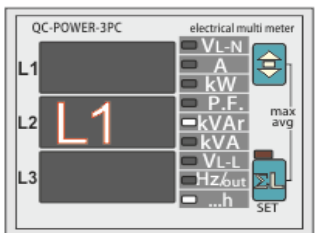

Visualization page 13.1
Reactive energy counted
L2 phase
82,8 kWh

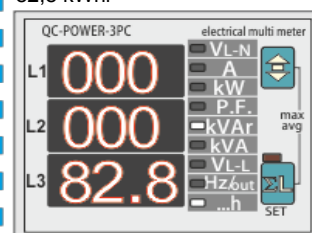

Visualization page 13.2
Phase of energy counted
L2 phase

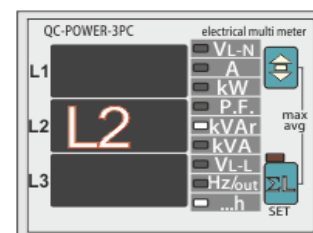

Visualization page 14.1
Reactive energy counted
L3 phase
82,8 kWh

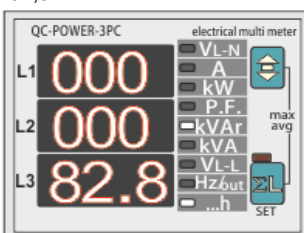

Visualization page 14.2
Phase of energy counted
L3 phase

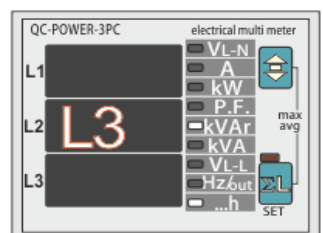



VISUALIZATION OF THE THREE PHASE VALUES

Visualization page 1

Σ VL-N on L1
 Σ IL on L2
 Σ kW on L3

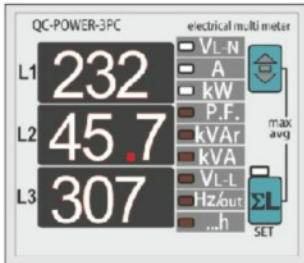

Visualization page 2

Σ PF on L1
 Σ kVAr on L2
 Σ kVA on L3

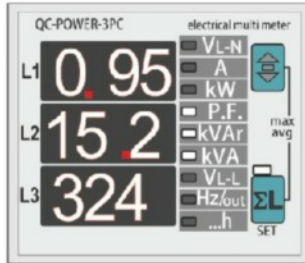

Visualization page 3

Σ VL-L on L1
Freq. on L2

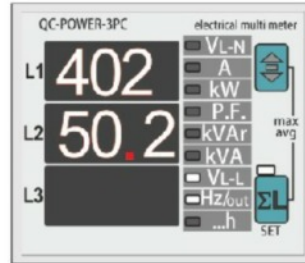

Visualization page 4

Three phase active energy counted
232,8 kWhr

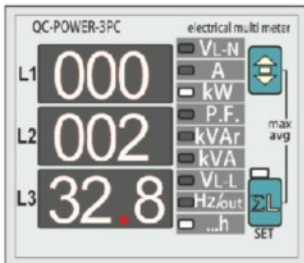

Visualization page 5

Three phase reactive energy counted
82,8 kWhr

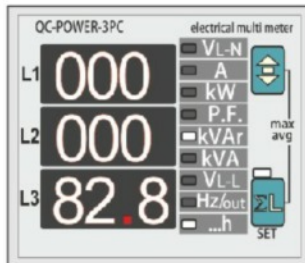

VISUALIZATION OF THE SINGLE PHASE VALUES (connection mode set to 1PH_L1)

Visualization page 1

Σ VL-N on L1
 Σ IL on L2
 Σ kWL1 on L3

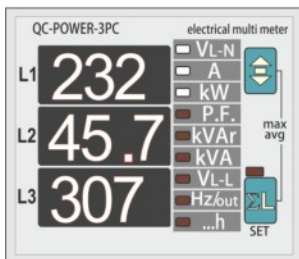

Visualization page 2

Σ PFL1 on L1
 Σ kVArL1 on L2
 Σ kVAL1 on L3

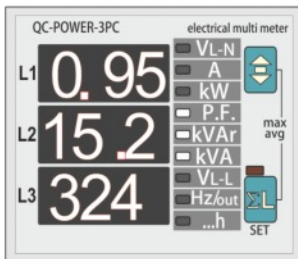

Visualization page 3

Freq. Phase L1
Address on L2
Transmission status on L3

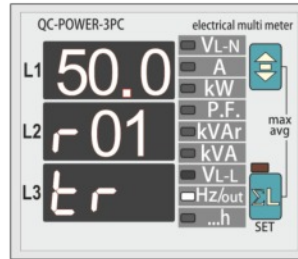

Visualization page 4
Active energy counted
L1 phase
232,8 kWhr

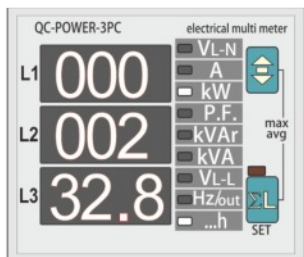

Visualization page 5
Reactive energy counted
L1 phase
82,8 kWhr

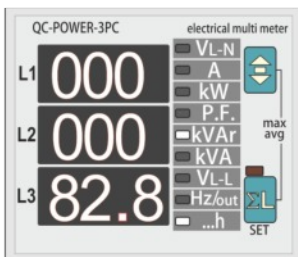



VISUALISATION PEAK VALUES (MAXIMUM) INSTANTANEUS AND AVERAGE.

By pressing the **A** and **B** keys simultaneously the instrument reaches the visualisation of the peak value (maximum): the visualised measures selectable by **B** key, they will start flashing alternatively with the indication of the type of the maximum value.

The maximum memorised values are of two types: the maximum instantaneous values, memorise the maximum reached value of the measured parameter, during at least 1 second, the indicated value will flash alternatively with the message PEA (peak); the average values memorise the average value reached, during the last **AVG T**, of the measured parameter, the value will flash alternatively with the message aug (AVeraGe).

The integration for the calculation of the values is synchronised at every switch on of the instrument

The maximum values, which may be selected with the **B** key are the following:

THREE-PHASE SYSTEM		
Parameter	Identification symbol	Value type
phase voltage	V L1-N max V L2-N max V L3-N max	PEA
phase current	I L1 max I L2 max I L3 max	PEA
average phase current (maximum demand)	I L1 max (avg) I L2 max (avg) I L3 max (avg)	MDM
three phase system powers	ΣW max ΣVAr max ΣVA max	PEA
average three-phase system powers (maximum demand)	ΣW max (avg) ΣVAr max (avg) ΣVA max (avg)	MDM
three phase system average powers	ΣW (avg) ΣVAr (avg) ΣVA (avg)	aug

SINGLE PHASE SYSTEM		
Parameter	Identification symbol	Value type
maximum phase voltage	V L1-N max	PEA
maximum phase current	I L1 max	PEA
maximum phase powers	ΣW max ΣVAr max ΣVA max	PEA
average phase current (maximum demand)	I L1 max (avg)	MDM
average phase powers (maximum demand)	ΣW max (avg) ΣVAr max (avg) ΣVA max (avg)	MDM
average phase powers	ΣW (avg) ΣVAr (avg) ΣVA (avg)	aug

NOTE relative to measures.

The refresh time of the displays is below 1 second, with a comfortable reading of the measures, even in presence of sudden variations of the measured parameters.

In case that the indicated measures aren't reliable or they are absurd, it's important to check carefully the current and voltage inputs connection, so as the phase sequence. Check that current and voltage correspond to the same phase (on input L1 it will be connected phase voltage L1 and the CT will be placed on phase L1), thence terminal S1 of CT will be wired to the relative terminal S1 on the instrument.



TECHNICAL CHARACTERISTICS

MEASURES AND ACCURACY	
Voltage	True rms value of the phases voltages and phase to phase in a three phase system Total range of measure: 20÷500V trms phase to phase- 380V rms phase-neutral – 40÷100Hz Visualization (20,0÷500V) - measure accuracy: $\pm 0,5\%$ ± 1 digit – maximum values management
Current	True rms value of phase currents and three phase system value Range of measure: 0,02÷5A trms digit – 40÷100Hz Visualization 0,02÷999A - accuracy: $\pm 0,5\%$ ± 1 - average and maximum values management
Frequency	Frequency of phase L1 – measuring range: 30÷500Hz Accuracy: $\pm 0,5\%$ ± 1 digit
Powers	Active, reactive and apparent powers of phase and three phase system Range of measure: 0,01÷999kW - 0,01÷999kVA _r - 0,01÷999kVA Accuracy: $\pm 1\%$ ± 1 digit - Maximum, average and instantaneous values management
Power factor	Phase and three phase power factor Range of measure: -0,1÷0,1 / accuracy: $\pm 1\%$ ± 1 digit - Maximum and average values management
Hour meter	Time metering in hours and decimal of hours Range of measure 0,0 ÷ 99999,9 h / accuracy $\pm 0,5\%$
Energy measures	Active, reactive and apparent energies of the three phase system Range of measure: 0÷99999999,9 kWh / kVA _r h / kVAh class 2 (IEC 1036) accuracy: $\pm 1\%$
AUXILIARY POWER SUPPLY AND INPUTS	
Auxiliary supply	Standard 230V $\pm 15\%$ - optional 110V or 400V $\pm 15\%$ - 50-60Hz - max 3VA
Voltage inputs	From 20 to 500V phase-phase; permanent overload +20% - input impedance: 1 M Ω 3, 4 and single phase wiring
Current inputs	From 0,02 to 5A; permanent overload 50% - from external CT's with secondary 5A (optional 1A), Primary programmable from 5 to 2000A - self-consumption <0,5VA
INPUTS/OUTPUTS	
Serial output RS485	One output RS485, baud rate selectable, MODBUS-RTU protocol, baud rate 4800÷19200 insulation: 3kV for 60 seconds
GENERAL	
Display, keys	3 display with red LED 7,5mm each of 3 digits 7 segments 2 keys for selecting measures and programming , LED bar 10 points
Mechanical	Protection degree: IP52 front - IP20 enclosure and terminals - weight: 0,3 kg approx. Screw wiring terminal for maximum cross section cable of 4 mm ² Self- extinguishing plastic enclosure – for DIN rail mounting, 3 modules of 17,5mm
Environment	Working temperature:-10÷60°C; humidity<95% - Storing temperature:-25÷70°C - Isolation test: 3kV for 1min.
Standards of reference and marks	CEI EN 50081-2; CEI EN 50082-1; CEI EN 61010-1; CEI-EN 61036

DIMENSIONS

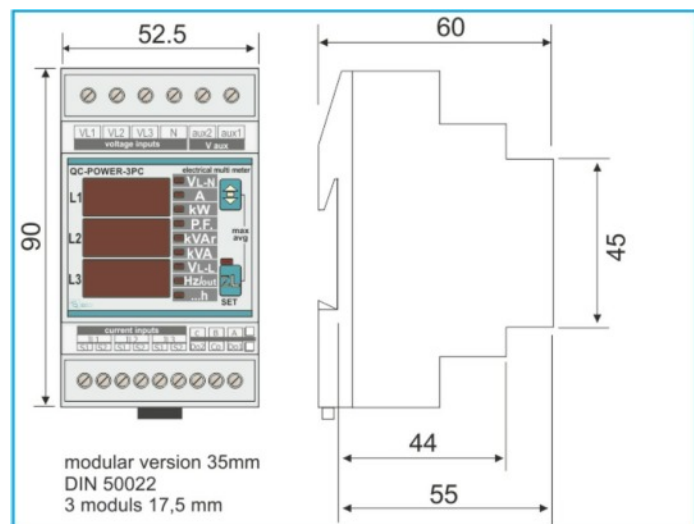



For any needs:

DEM spa
Zona Industriale Villanova, 20
32013 Longarone (BL) – Italy

Tel. +39 0437 761021
Fax +39 0437 760024

info@qeed.it
www.qeed.it

QEEED THE ELECTRONIC BRAND OF **D.E.M.** S.p.A.
DEM S.p.A. - Z.I. Villanova, 20 - 32013 Longarone (BL), Italy - www.dem-it.com - Ph. +39 0437 761021