



## QC-ENERGY-3T



★ NEW ★

**E.M.**  
ELECTRONIC PERFORMANCE**QEED**  
QUALITY ELECTRONIC DESIGN

Vai alla pagina **QC-ENERGY-3T**  
per novità, aggiornamenti e download

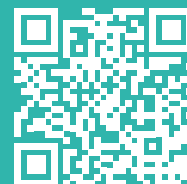
**SOMMARIO**

Panoramica del prodotto	3
Caratteristiche tecniche	4
Caratteristiche elettriche	4
Misure disponibili	5
Caratteristiche comunicazione	6
Dati generali	6
Codice d'ordine	7
Connessione e installazione	8
Terminazione BUS RS485	10
Esempio utilizzo trasduttori di corrente	10
Allarmi su uscita digitale	11
Precisione (secondo EN50470-3 e EN62053-24)	12
Menu TFT	13
Configurazione del dispositivo	14
Web Server	14
Misure in tempo reale	15
Modbus RTU	16

Modbus TCP	16
Ethernet	16
Wi-Fi STA	16
Wi-Fi AP	16
Impostazioni Dispositivo	16
Aggiornamento FW	16
Pagina Lingua & Timezone	16
Carica/Scarica configurazione	16
Master Modbus di terze parti	17
Funzione 03 esadecimale (Lettura dei registri di mantenimento)	17
Funzione 06 esadecimale (Scrittura di un singolo registro di mantenimento)	18
Funzione 10 esadecimale (Scrittura di registri multipli)	19
Registro "Configuration register" 40007	20
Mappa dei registri	21



## AVVISI E AVVERTENZE DI SICUREZZA

Di seguito sono elencate avvertenze di sicurezza ed informazioni da osservare per garantire la propria sicurezza personale e prevenire danni materiali.



La mancata osservanza dell'avvertenza può provocare **morte o gravi lesioni personali**.



La mancata osservanza dell'avvertenza potrebbe causare **danni materiali o gravi lesioni personali**.



Il costruttore **declina ogni responsabilità in merito alla sicurezza** elettrica in caso di utilizzo improprio dell'apparecchio.



ATTENZIONE: Oggetto in classe II, come da norma "EN 61140:2004-05 "Protezione contro i contatti elettrici - Aspetti comuni per gli impianti e le apparecchiature - Collegamento equipotenziale", **è vietata la messa a terra dello strumento** onde danneggiare il dispositivo e ridurre la sicurezza dell'impianto.



Prima di eseguire qualsiasi operazione è obbligatorio leggere tutto il contenuto del presente manuale.

L'installazione e la messa in servizio devono essere eseguite esclusivamente da personale addestrato.



Prima della messa in servizio verificare che:

- non vengano superati i valori massimi di tutti i collegamenti, vedere il datasheet del prodotto;
- i cavi di collegamento non siano danneggiati e che non siano sotto tensione durante il cablaggio;
- la direzione del flusso di potenza e la rotazione delle fasi siano corrette.

Durante l'installazione, assicurarsi che sia installato un interruttore o un disgiuntore in prossimità del prodotto e che sia facilmente accessibile agli operatori.

Lo strumento deve essere disinstallato se non è più possibile garantire un funzionamento sicuro (ad es. danni visibili). In questo caso tutti i collegamenti devono essere scollegati. Lo strumento deve essere restituito alla fabbrica o ad un centro di assistenza autorizzato.



ATTENZIONE: campi magnetici di elevata intensità possono variare i valori misurati dal trasformatore. Evitare l'installazione nei pressi di: magneti permanenti, elettromagneti o masse di ferro. Se si riscontrano irregolarità, riorientare o spostare il dispositivo nella zona più appropriata.



Se le avvertenze non sono rispettate, il dispositivo potrebbe **danneggiarsi o non funzionare** come previsto.



Si prega di notare che i dati sulla targhetta devono essere rispettati.



È necessario rispettare le normative nazionali durante l'installazione e la scelta dei materiali per le linee elettriche



Riparazioni e modifiche devono essere eseguiti esclusivamente dal produttore. È vietato aprire la custodia e apportare modifiche allo strumento. In caso di manomissione del dispositivo decade il diritto di garanzia.



Il prodotto descritto in questo documento può essere utilizzato solo per l'applicazione specificata. È necessario rispettare i dati di alimentazione massima e le condizioni ambientali specificate nel datasheet di prodotto. Per il corretto e sicuro funzionamento dell'apparecchio sono necessari un trasporto e uno stoccaggio adeguati, nonché un montaggio, un'installazione, una movimentazione e una manutenzione professionali.

L'utilizzo in condizioni ambientali diverse dai limiti dichiarati, l'applicazione di segnali, tensioni correnti oltre i limiti dichiarati, possono provocare deviazioni anche significative delle tolleranze di misura dichiarate, anche irreversibili.



Il contenuto di questo documento è stato controllato per garantirne l'accuratezza, tuttavia potrebbe contenere errori o incongruenze e non è possibile garantirne la totale completezza o la correttezza.



Il documento è regolarmente soggetto a revisioni ed aggiornamenti. QEED si riserva la facoltà di apportare in qualsiasi momento modifiche al prodotto e/o alla relativa documentazione tecnica, in ottica di miglioramento continuo della qualità. Accertarsi di consultare la versione aggiornata della documentazione disponibile sul sito web

[www.qeed.it](http://www.qeed.it)

In caso di errori o mancanza di informazioni necessarie in questo documento, vi preghiamo di informarci via e-mail a:

[technical@qeed.it](mailto:technical@qeed.it)



Smaltimento dei rifiuti elettrici ed elettronici (applicabile nell'Unione Europea e negli altri paesi con servizio di raccolta differenziata). Il simbolo presente sul prodotto o sulla sua confezione indica che il prodotto non verrà trattato come rifiuto domestico. Sarà invece consegnato al centro di raccolta autorizzato per il riciclo dei rifiuti elettrici ed elettronici. Assicurandovi che il prodotto venga smaltito in modo adeguato, eviterete un potenziale impatto negativo sull'ambiente e la salute umana, che potrebbe essere causato da una gestione non conforme dello smaltimento del prodotto. Il riciclaggio dei materiali contribuirà alla conservazione delle risorse naturali. Per ricevere ulteriori informazioni più dettagliate Vi invitiamo a contattare l'ufficio preposto nella Vostra città, il servizio per lo smaltimento dei rifiuti o il fornitore da cui avete acquistato il prodotto.



## PANORAMICA DEL PRODOTTO

Il QC-ENERGY-3T è un analizzatore di rete trifase con ingresso universale per trasformatori amperometrici in grado di gestire sensori di corrente (con uscita in tensione  $0\div333\text{mV}$  o corrente 1A o 5A e sonde di Rogowski) e disponibile in 3 versioni con differenti misure disponibili.

Il prodotto dispone di un display grafico TFT 128x64 65536 colori per visualizzare le grandezze e le impostazioni del prodotto; i tasti presenti a fianco allo stesso permettono di scorrere tra i menù disponibili.

Dotato di porta ethernet, Wi-Fi e uscita RS485 Modbus RTU, può essere facilmente integrato nei sistemi di monitoraggio ed acquisizione. Tutte le grandezze e funzionalità sono configurabili Web Server con 3 modalità di interfacciamento Ethernet, Wi-Fi - AP e Wi-Fi - STA o con un master modbus di terze parti agendo sui registri dedicati.

Conforme alla classe 0,5S (kWh) della EN62053-22 e alla classe 0,5S (kVARh) della EN62053-24, ha una precisione pari a  $\pm 0,5\%$  RDG. Il QC-ENERGY-3T è in grado di effettuare misure in TRMS di forme d'onda distorte (tensione/corrente) ed effettuare l'analisi degli sfasamenti.

Le varie uscite sono isolate rispetto agli ingressi (le porte ethernet, RS485 e le due uscite digitali sono galvanicamente isolate sia dall'alimentazione che dagli ingressi di misura).

Dispone di due contatti digitali (open drain NPN) per conteggio impulsivo e allarme.

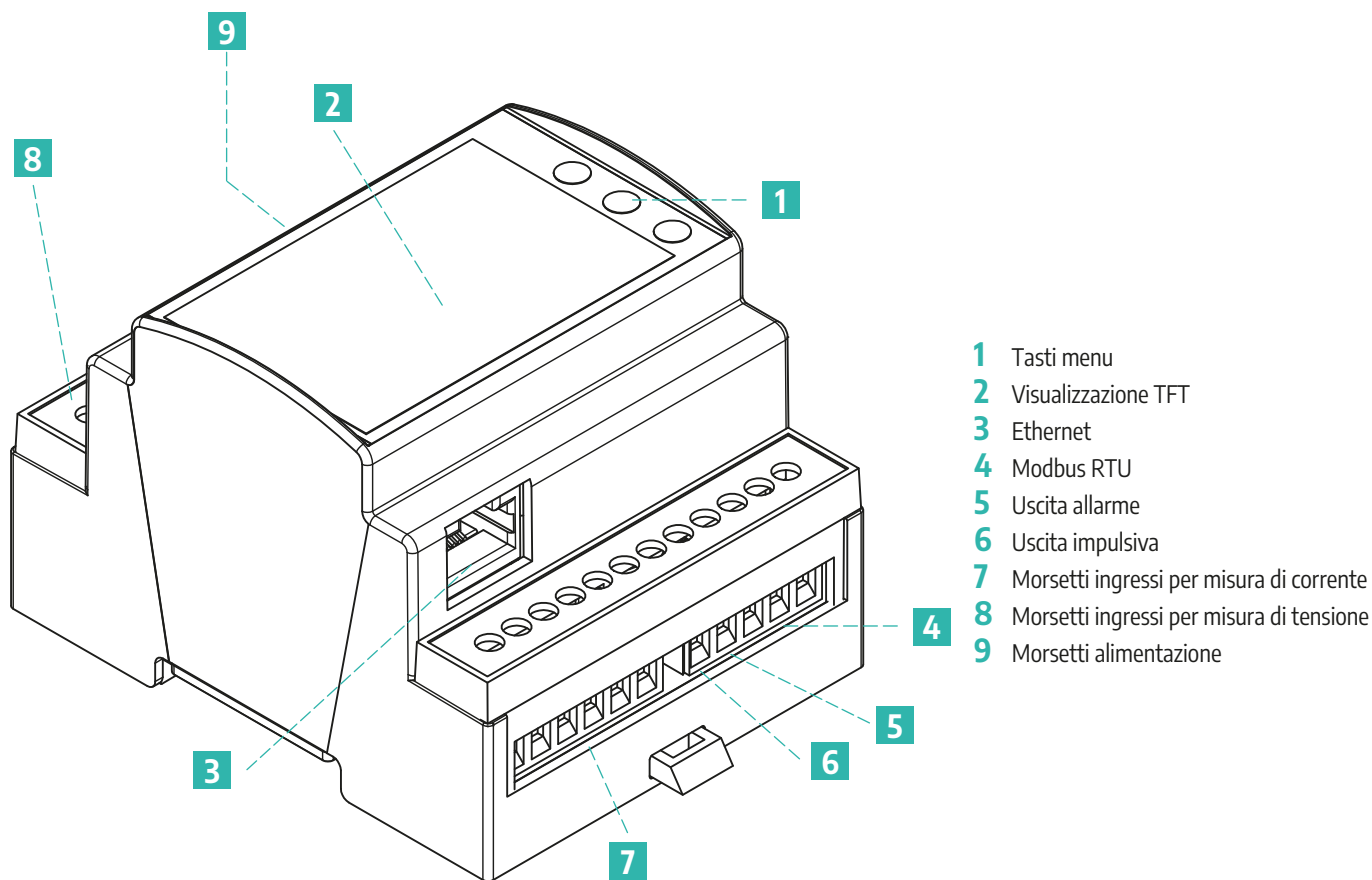



## CARATTERISTICHE TECNICHE

### Caratteristiche elettriche

Alimentazione	85÷265 V <sub>AC</sub>
Frequenza	50/60 Hz
Assorbimento	100 mA max
Isolamenti	4 kV <sub>RMS</sub> tra alimentazione e interfacce di comunicazione/uscite digitali 4 kV <sub>RMS</sub> tra ingressi di misura e interfacce di comunicazione/uscite digitali 1,5 kV <sub>RMS</sub> tra alimentazione e ingressi di misura
Ingressi tensione	Connessione diretta fino a 500V <sub>RMS</sub> massimo Rapporto di trasformazione per trasformatori di tensione e corrente configurabile
Ingressi corrente	1 A o 5 A Sonde di Rogowski 0÷333 mV
Uscite	#2 uscite open drain (NPN): 1x uscita digitale (allarme con soglia) - max 60 V, 40 mA 1x uscita digitale (contatore di impulsi - larghezza impulso 100ms) normalmente chiusa - max 40 V, 150 mA
Interfaccia di comunicazione	Ethernet 10/100 Wi-Fi AP-STA RS485 Modbus RTU
Interfaccia visiva	Display
Tipo misura	TRMS
Frequenza di misura	1-70Hz
Frequenza di campionamento	Variabile: pari a 128 * Freq <sub>rete</sub> nel range 9-70Hz Fissa: pari a 6400 campioni/s al di fuori del range sopra indicato
Aggiornamento della misura	configurabile da software Default: ogni 50 cicli (AC), max: 65535 cicli
Rapporti di trasformazione	TA e TV default 1,0; Impostabili da software
Angolo di sfasamento trasformatori	default 0,0° @50Hz; impostabile da software
Soglia minima di visualizzazione	Impostabili su tensione, corrente e potenza
<b>Ingresso di tensione</b>	
Impedenza di ingresso	400 kΩ
Portata nominale U <sub>n</sub>	300 V <sub>LN</sub> / 500 V <sub>LL</sub>
Sovraccarico Continuo U <sub>MAX</sub>	400 V <sub>LN</sub> / 700 V <sub>LL</sub>
Sovraccarico Per 500 ms	600 V <sub>LN</sub> / 1000 V <sub>LL</sub>
<b>Ingresso di corrente</b>	
Non isolato (necessari TA)	
<b>TA con uscita in corrente</b>	
Portata nominale I <sub>n</sub>	5 A <sub>AC</sub>
Fattore di cresta	< 4 (20 A <sub>PK</sub> MAX)
Impedenza	<0,5 Ω per fase
Sovraccarico Continuo I <sub>MAX</sub>	6 A <sub>AC</sub>
Sovraccarico Per 500 ms	40 A <sub>AC</sub>
<b>TA con uscita in tensione</b>	
Portata nominale V <sub>n</sub>	333 mV <sub>AC</sub>
Fattore di cresta	< 3 (1 V <sub>PK</sub> MAX)
Impedenza	220 kΩ
Sovraccarico Continuo I <sub>MAX</sub>	2,1 V <sub>PK</sub>
Sovraccarico Per 500 ms	13 V <sub>PK</sub>



Precisioni (@25°C, 50Hz)	
Tensione (Un: 230/400 V)	± 0,5% RDG (10÷100% Un)
Corrente (In= 5A)	± 0,5% RDG (5÷100% In)
Frequenza (40÷70Hz)	±0,1Hz
Potenza	ATTIVA: ± 0,5% RDG REATTIVA: ± 0,5% RDG
Energia	ATTIVA: Classe C secondo le EN50470-1/3 oppure Classe 0,5S secondo le EN62053-22 REATTIVA: Classe 0,5S secondo EN62053-24
Fattore di potenza	± (0,001 +1% (1.00-PF))
Banda passante (-3dB)	>2 kHz
Coefficiente di temperatura	<100 ppm/°C

## Misure disponibili

	Modello		
	STANDARD	PLUS	PRO
Irms - Vrms - Ipk - Vpk per fase	✓	✓	✓
Potenza attiva (W), Potenza reattiva (VAR), Potenza apparente (VA) per fase	✓	✓	✓
Energia bidirezionale (kWh), positiva e negativa per fase e totale	✓	✓	✓
Energia attiva e reattiva (kVARh), induttiva/capacitiva, per fase e totale	✓	✓	✓
Fattore di potenza (induttiva/capacitiva) per fase e totale	✓	✓	✓
Fattore di cresta per fase e totale	✓	✓	✓
Frequenza	✓	✓	✓
Cosφ per fase e medio	✓	✓	✓
Tanφ per fase e medio		✓	✓
Fattore di potenza min, med e max per fase e medio		✓	✓
Distorsione fattore di potenza (induttiva/capacitiva) per fase e medio		✓	✓
THD (V, I), TDD		✓	✓
Potenze min, med e max		✓	✓
Controllo sequenza fasi		✓	✓
Picco richiesta potenza, per fase e totale			
Memorizzazione (mensile) del raggiungimento della massima potenza richiesta (mese, giorno, ora, minuti), per fase e totale		✓	✓
Tempo oltre soglia impostabile, per fase e totale		✓	✓
Fattore K (secondo IEEE Standard 1100-1992)		✓	✓
Temperatura interna [°C]		✓	✓
Analisi armonica fino alla 63esima			✓
Analisi interarmonica fino alla 63ma			✓
SAG, SWELL, Buchi di tensione			✓



## Caratteristiche comunicazione

Protocolli comunicazione	Wi-Fi	Frequenza	2.4GHz
	Modbus RTU	Indirizzi	1÷247 (default 1)
		Formato dati	1 bit di start, 8 bit dati, parità NO/ODD/EVEN (default NO parità)
		Ritardo alla risposta	1÷1000ms
	Modbus TCP	Numero connessioni supportate	2
Porta ingresso		502	
Interfacce di comunicazione	Ethernet	Connessione	DHCP attivo di default, possibilità di disattivare e di impostare i dati manualmente.
		Velocità supportata	10/100 Mbps
		Tipo Collegamento	Connettore RJ45 (10 Base-T, 100 Base-TX), distanza massima 100m
		Funzioni supportate	Modbus TCP, Web Server
	Wi-Fi Access Point	Connessione	SSID e PW
		Funzioni supportate	Web Server
		Numero massimo station connesse contemporaneamente	8
	Wi-Fi Station	Connessione	- DHCP attivo di default - SSID e PW dell'access point a cui ci si vuole connettere
		Funzioni supportate	Web Server
	RS485	Baudrate	1200...115200 baud (default 9600)
Connessione		Tramite morsetto estraibile 3 poli	
Funzioni applicativo	Web Server	Numeri massimo client supportati	Nessun limite (nel caso di multipli client l'utilizzo del Web Server potrebbe risultare molto più lento)

## Dati generali

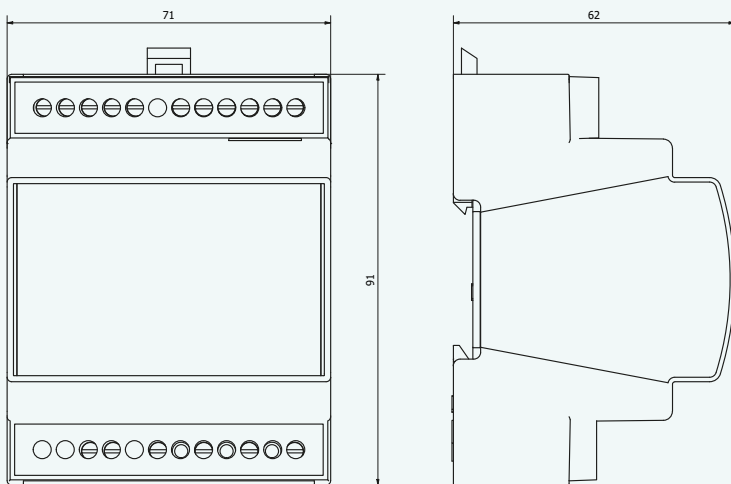
Temperatura di funzionamento	-15÷60° C
Temperatura di stoccaggio	-40÷85° C
Umidità relativa	10÷90% non condensante
Altitudine	Fino a 2000 m s.l.m.
Memorizzazione energia	Flash, durata minima 1.000k scritture
Grado di protezione	Contenitore IP20 Frontalino display IP54
Dimensioni	4 DIN (90,5 x 71 x 62mm) 
Peso	168 g
Sezione cavi dei terminali	0.05÷1.5 mm <sup>2</sup> (30÷14 AWG)



Omologazioni e certificazioni	EN61000-6-2; EN61000-6-4; EN61000-4-2; EN61000-4-3; EN61000-4-4; EN61000-4-5; EN61000-4-6; EN61010-1; EN61010-2-30  
Montaggio	All'interno di quadri elettrici con predisposizione per barra DIN

### Codice d'ordine

Versione STANDARD	QC-ENERGY-3T-STD
Versione PLUS	QC-ENERGY-3T-PLUS
Versione PRO	QC-ENERGY-3T-PRO



## CONNESSIONE E INSTALLAZIONE

Lo strumento è sviluppato per essere installato all'interno di quadri elettrici e montato su guida DIN.

Tutti i morsetti di connessione sono visualizzati sulla tampografia riportata sul prodotto e corrispondono alla figura seguente:

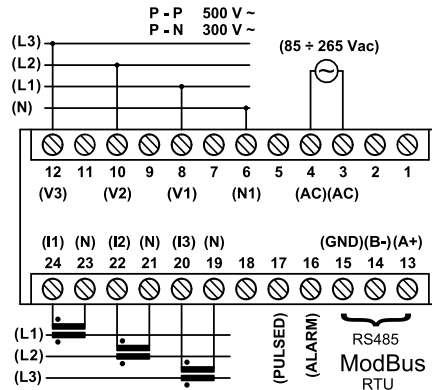

Di seguito la descrizione delle funzionalità dei morsetti:

<p>85-265 V<sub>AC</sub></p>	<p>Alimentazione dispositivo <b>NOTA:</b> Le linee devono essere dotate di un'opportuna protezione contro cortocircuiti e/o guasti accidentali</p>
<p>F L1 L2 L3 N</p>	<p>Collegamento trifase, 4 fili, connessione con 3 TA*  Per la tipologia dei fusibili, fare riferimento alla Nota 1) in fondo a questa tabella.</p>
<p>L1 L2 L3 N</p>	<p>Collegamento trifase, 4 fili, connessione con 3 TA* e 3 TV</p>
<p>F L1 L2 L3</p>	<p>Collegamento trifase, 3 fili, connessione con 3 TA*  Per la tipologia dei fusibili, fare riferimento alla Nota 1) in fondo a questa tabella.</p>
<p>L1 L2 L3</p>	<p>Collegamento trifase, 3 fili, connessione con 3 TA* e 3 TV</p>

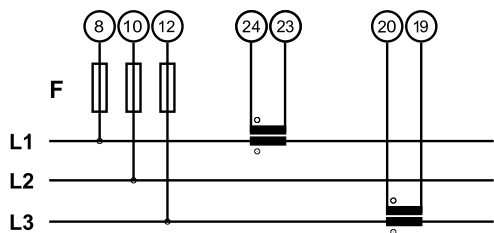

Collegamento trifase, 3 fili, connessione con 2 TA\* (Aron)

Per la tipologia dei fusibili, fare riferimento alla Nota 1) in fondo a questa tabella.

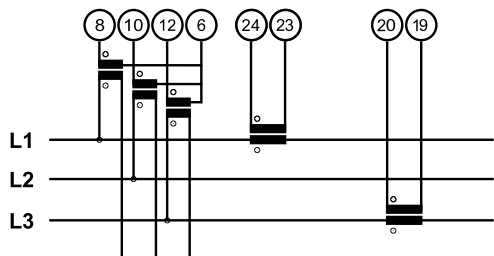

Collegamento trifase, 3 fili, connessione con 2 TA\* e 3 TV (Aron)

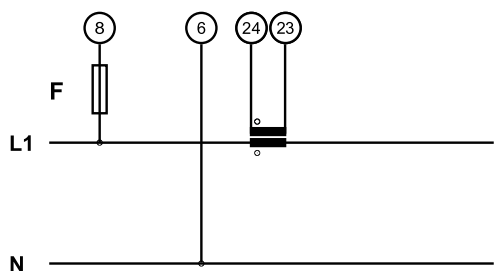

Collegamento monofase, 2 fili, connessione con 1 TA\*

Per la tipologia dei fusibili, fare riferimento alla Nota 1) in fondo a questa tabella.

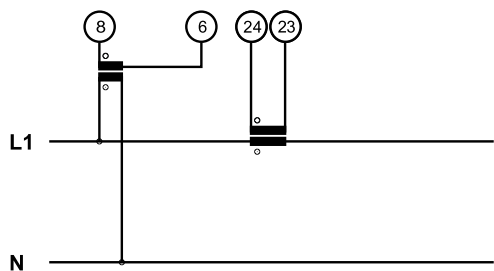

Collegamento monofase, 2 fili, connessione con 1 TA\* e 1 TV

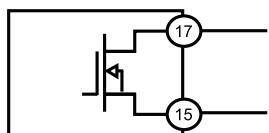

Uscita digitale per conta energia

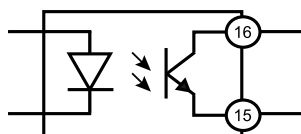

Uscita digitale per allarme

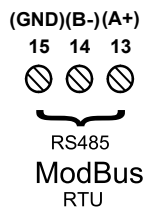

Collegamento RS485 Modbus RTU: morsetti 13 (A+), 14 (B-), 15 (GND)

**Nota 1)** Fusibili da 250 mA ad intervento rapido / sezionatore

I fusibili/interruttori automatici devono essere:

- Installati in conformità con tutti i codici e gli standard elettrici locali e nazionali.
- Validi per la tensione di installazione, la corrente di guasto disponibile e dimensionati per i carichi collegati.

\* **ATTENZIONE:** i TA non devono essere collegati a terra.



### Terminazione BUS RS485

Al fine di evitare sbilanciamenti nel bus di trasmissione, è consigliabile inserire una resistenza di terminazione all'inizio del bus RS485 (tipicamente sull'adattatore USB-RS485) ed alla fine (tipicamente in concomitanza dell'ultimo slave). È opportuno scegliere resistenze da 120Ω con tolleranza 1%, che equivalgono all'impedenza tipica dei cavi RS485.

Sotto delle immagini a puro titolo indicativo:



Figura 2: Terminazione bus RS485

### Esempio utilizzo trasduttori di corrente

In base alla tipologia di trasduttore usato e alla corrente del sistema misurato, potrebbe essere necessario effettuare più avvolgimenti sul nucleo del trasduttore per fare in modo che la corrente misurata sia a centro scala dello strumento di acquisizione del dato. In questo caso, cambiare il rapporto di trasformazione agendo sul reg. 40009.

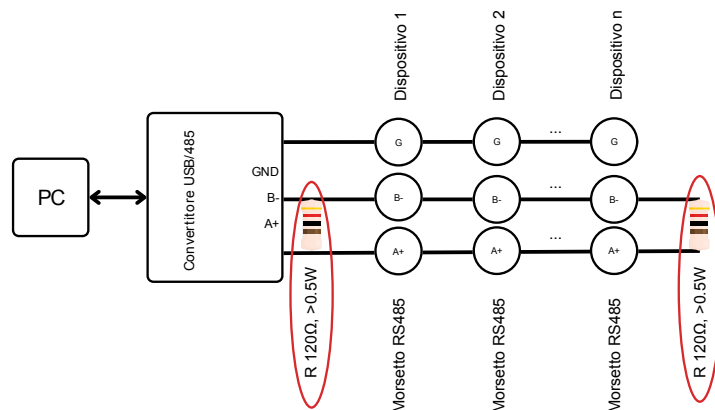

installazione normale  
(1 passaggio attraverso il nucleo)



2 spire  
(2 passaggi attraverso il nucleo)



4 spire  
(4 passaggi attraverso il nucleo)

Figura 3: esempi di avvolgimenti



**ALLARMI SU USCITA DIGITALE**



Figura 4: Allarme sopra soglia



Figura 5: Allarme sotto soglia

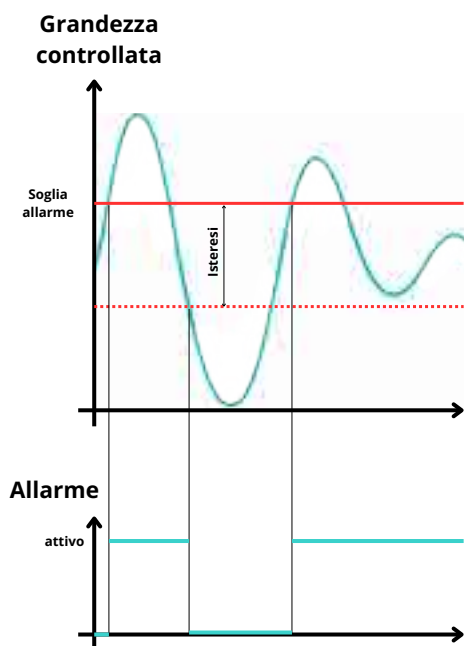

Figura 6: Allarme tra le soglie

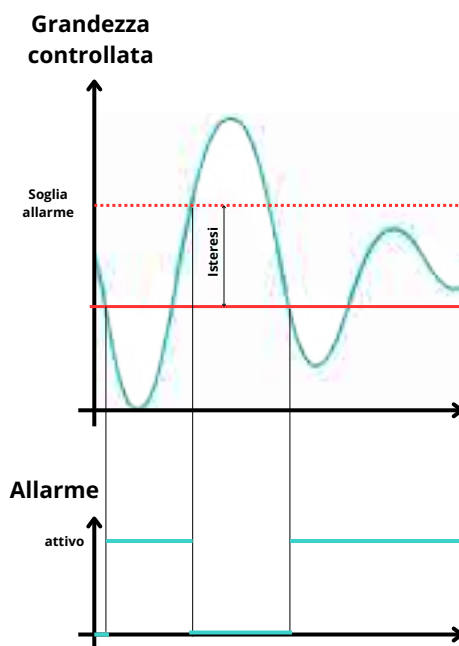

Figura 7: Allarme fuori dalle soglie

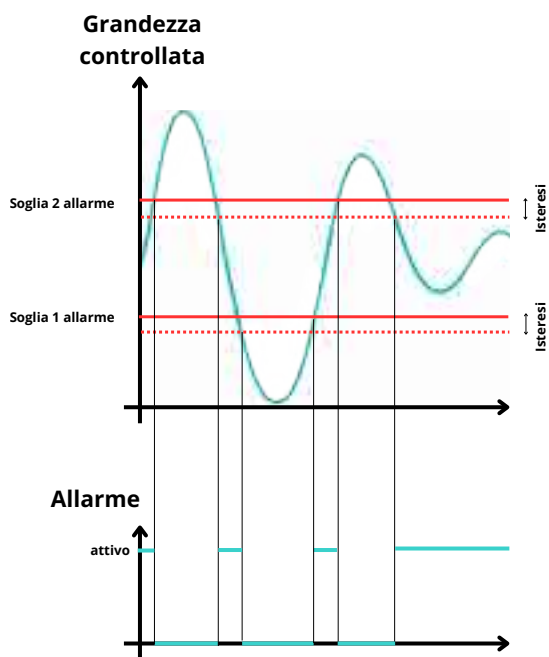

PRECISIONE (SECONDO EN50470-3 E EN62053-24)

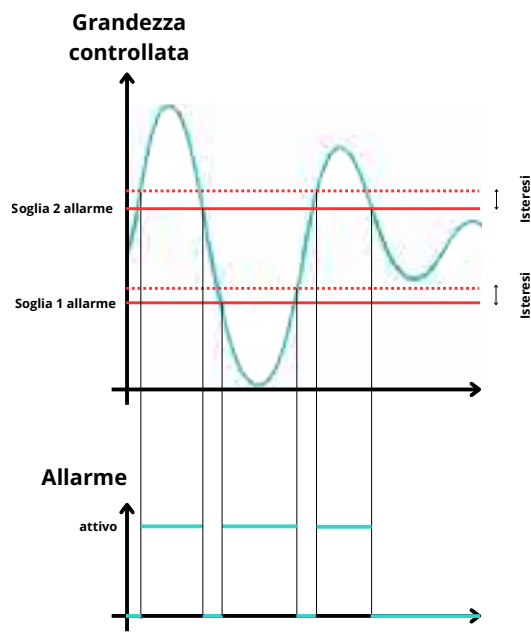

Figura 8: Wh, precisione in funzione del carico (TA con uscita in corrente)



Figura 9: Wh, precisione in funzione del carico (TA con uscita in tensione)

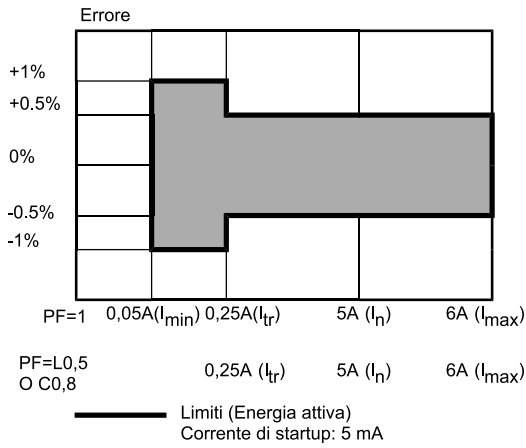

Figura 10: VARh, precisione in funzione del carico (TA con uscita in corrente)

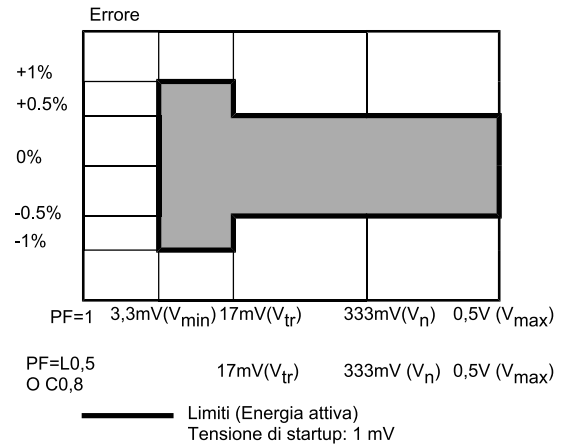

Figura 11: VARh, precisione in funzione del carico (TA con uscita in tensione)

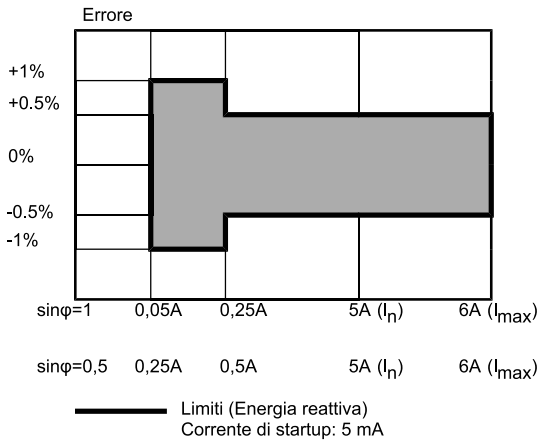

## MENU TFT

All'accensione del prodotto, il display visualizzerà la pagina Energie (1/8) dove sono visualizzate le energie attiva/reattiva/apparente.

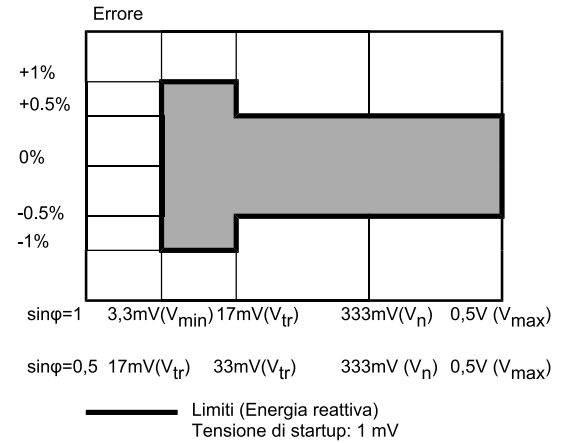
Dopo un periodo di inattività impostabile dall'utente (pagina webserver dedicata), il display può entrare in modalità "screen saver" per preservare la durata del prodotto e può essere riattivato premendo uno qualsiasi dei tasti.

Per muoversi tra i menu, utilizzare le 2 frecce sul frontalino del display e premere per confermare. Per accedere al menu principale, premere in modo da portarsi alla pagina:



- Visualizzazione misure

- Impostazioni

- Configurazione corrente

Dal menu impostazioni è possibile verificare e modificare le impostazioni:

- Wi-Fi AP (1/6)
- Wi-Fi STA (2/6)
- Ethernet (3/6)
- Modbus RTU (4/6)
- Modbus TCP (5/6)
- Generali (6/6)

Da ogni menu, con le frecce è possibile muoversi tra le varie voci e con il tasto selezionare quella si vuole modificare. Successivamente alla pressione si aprirà una schermata con un tastierino, che verrà incorniciato di rosso per indicare che ora è possibile muoversi tra i vari tasti, per digitare le modifiche. Una volta confermate le modifiche da tastierino, sarà possibile accettare o scartare le modifiche i relativi pulsanti **CANCELLA** e **ACCETTA**.

Premuto uno dei 2 tasti di conferma/annullamento si verrà indirizzati al menu precedente, dove i parametri modificati verranno successivamente visualizzati in giallo.

Per confermare tutte le modifiche inserite, sarà necessario premere sul pulsante dove si sarà indirizzati alla pagina iniziale che presenterà un box di conferma per l'invio delle modifiche al dispositivo

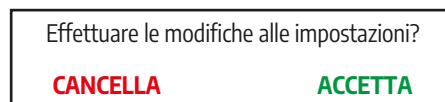

Premuto il pulsante **ACCETTA** la macchina si riavvierà per rendere le modifiche effettive





## CONFIGURAZIONE DEL DISPOSITIVO

È possibile collegarsi al prodotto tramite porta ethernet, Wi-Fi o mediante un dispositivo seriale RS485 come il nostro Q-USB485.

La configurazione del modulo può essere effettuata tramite il Web server integrato o con qualsiasi master Modbus di terze parti agendo sui registri della mappa riportata nell'ultimo capitolo di questo documento.

### Web Server

Ci sono 3 modalità per accedere al Web Server del prodotto. Via Ethernet, in modalità Wi-Fi Station (STA) o Wi-Fi Access Point (AP).

#### - Connessione via cavo Ethernet:

- Se è impostato il DHCP, è sufficiente collegare un cavo ethernet della vostra rete cablata e attendere che venga fornito un indirizzo IP dal router. L'IP a cui collegarsi con un browser è visualizzato nel menu del dispositivo Home/Setting/Ethernet (3/6) visibile sul TFT del prodotto.
- Se non è impostato il DHCP, è necessario impostare manualmente indirizzo IP, Gateway e Netmask in modo tale che il QC-ENERGY-3T ed il PC facciano parte di una stessa rete. NB: al QC-ENERGY-3T non deve essere assegnato un IP già presente nella rete per evitare conflitti.

#### - Connessione con Wi-Fi STA: è necessario connettere il prodotto alla vostra rete Wi-Fi inserendo il nome della rete e la password relativa.

- Se è impostato il DHCP l'IP a cui collegarsi con un browser è fornito dal router ed è visualizzato nel menu del dispositivo Home/Setting/Wi-Fi STA (2/6) visibile sul TFT del prodotto.
- Se non è impostato il DHCP, seguire le indicazioni indicate per la connessione ethernet senza DHCP.

#### - Connessione con Wi-Fi AP: connessione per mezzo della rete "QC-ENERGY-3T-xxxxx" generata dal dispositivo, inserendo la password (modificabile) e IP accessibili dal menu del dispositivo Home/Setting/Wi-Fi AP (1/6)

Una volta collegati al dispositivo, digitare username/PW impostati per il dispositivo; i valori di default sono admin/admin.



Tali valori possono essere modificati per mezzo dei tasti presenti sul frontalino del prodotto accedendo alla pagina 6/6 del menu impostazioni.

I menu del webservice sono molto intuitivi e non necessitano di particolari spiegazioni.

La schermata principale Home visualizza le impostazioni correnti del dispositivo



Dalla schermata principale è possibile avere una visione immediata di quelle che sono le configurazioni del dispositivo.

È inoltre possibile modificare username/password di accesso al webservice.

Premendo invece sulle icone a lato è possibile accedere ai menu di seguito descritti.

### Misure in tempo reale

In questa sezione sono disponibili diversi tab dove sono visualizzati in tempo reale tutti quelli che sono gli stati del dispositivo, le misure delle energie (attiva, reattiva ed apparente), i valori RMS di tensioni, correnti, potenze, PF e crest factor, i valori di picco di tensione e corrente, i valori RMS di tensioni, correnti, potenze e PF ed infine il valore delle varie armoniche.

Nella stessa sezione è possibile anche impostare i valori delle energie per quei registri indicati come R/W nella mappa dei registri.

Solamente per la versione PRO, il dispositivo è in grado di effettuare l'FFT fino alla 63ma armonica, permettendo di valutare la qualità dei segnali di ingresso con la misura delle componenti di frequenza ("armoniche") presenti. Tale funzionalità è garantita nell'intervallo di frequenza 9-70Hz.

Oltre ai valori puntuali, dal menu "Misure in Tempo Reale >> Armoniche >> Plot" è possibile visualizzare un istogramma delle armoniche.





## Modbus RTU

In questa sezione è possibile andare a variare le impostazioni del Modbus RTU.

## Modbus TCP

In questa sezione è possibile andare a variare le impostazioni del Modbus TCP.

## Ethernet

In questa sezione è possibile abilitare/disabilitare il DHCP e andare ad impostare i campi di IP, Netmask e Gateway personalizzati, che saranno validi nel caso in cui venga tolta la spunta al box "DHCP Attivo"

## Wi-Fi STA

In questa sezione sono visibili le reti wireless disponibili. Selezionandone una, è possibile accedere alla rete selezionata inserendo le credenziali di accesso (se presenti).

## Wi-Fi AP

In questa sezione è possibile andare a variare quelli che sono i parametri per l'accesso a dispositivo tramite Wi-Fi in modalità Access Point. Si possono variare l'Hostname, l'SSD, la password di accesso, l'IP, il Netmask e il Gateway.

## Impostazioni Dispositivo

In questa sezione è possibile andare a:

- Impostare i parametri di configurazione legati alle misure
- Impostare i parametri di configurazione legati a potenze ed energia
- Impostare gli allarmi
- Impostare data e ora (solo versione PLUS e PRO)
- Impostare i valori di power quality (solo versione PRO)
- Impostare screen saver display

## Aggiornamento FW

In questa sezione è possibile andare ad aggiornare il FW del display del prodotto selezionando il file .bin precedentemente salvato sul pc.

Eventuali nuovi rilasci di FW sono resi disponibili sul nostro sito alla pagina del dispositivo.

Successivamente ad un aggiornamento FW, potrebbe essere necessario ricaricare (aggiornare) la pagina webserver del browser.

## Pagina Lingua & Timezone

In questa sezione è possibile andare a commutare la lingua del Webserver e del prodotto tra italiano ed inglese.

È inoltre possibile impostare il fuso orario di installazione del prodotto.

## Carica/Scarica configurazione

In questa sezione è possibile andare a scaricare le impostazioni di un prodotto su file esterno da salvare oppure caricare una configurazione precedentemente salvata.



## Master Modbus di terze parti

In alternativa, si può mettere in comunicazione il prodotto direttamente con un Master Modbus RTU di terze con impostazioni di comunicazione in accordo con la configurazione dei dip-switch (indirizzo, baudrate).

Il protocollo di comunicazione supportato è il Modbus RTU Slave:

- Connessioni Modbus RTU: A+ e B- come previsto dagli standard Modbus RTU
- Funzioni Modbus RTU supportate: 03 esadecimale (lettura registri multipli, max 100), 06 esadecimale (scrittura singola), 10 esadecimale (scrittura registri multipli)
- la numerazione degli indirizzi Modbus RTU è con convenzione "1 BASED" (standard) ma il registro fisico è a base 0; all'indirizzo logico, per es. 40010, corrisponde l'indirizzo fisico #9, come previsto dagli standard Modbus RTU

**NOTA:** tutti i cambi di impostazione dei parametri di configurazione devono essere seguiti dal comando di salvataggio in flash 0xC1C0 = Flash settings save command nel registro 40244; i cambi dei parametri di comunicazione del dispositivo in aggiunta devono anche essere seguiti anche dal comando 0xC1A0 = Reboot command nel registro 40244.

In questo caso tutte le configurazioni del dispositivo saranno eseguite agendo sulla Mappa dei Registri Modbus RTU disponibile nell'ultimo capitolo di questo documento utilizzando le funzioni:

- Lettura dei registri di mantenimento (funzione 03 esadecimale)
- Scrittura di un singolo registro di mantenimento (funzione 06 esadecimale)
- Scrittura di registri multipli (funzione 10 esadecimale)

### Funzione 03 esadecimale (Lettura dei registri di mantenimento)

Questa funzione viene utilizzata per leggere il contenuto di un blocco continuo di registri di mantenimento (word). Il frame di richiesta specifica l'indirizzo del registro di partenza e il numero di registri da leggere. È possibile leggere al massimo 120 registri (parole) con una singola richiesta, quando non diversamente specificato. I dati del registro nel messaggio di risposta sono impacchettati come due byte per registro (word), con i contenuti binari allineati a destra all'interno di ciascun byte. Per ogni registro, il primo byte contiene i bit di ordine superiore (MSB) e il secondo contiene i bit di ordine inferiore (LSB).

Frame di richiesta			
Descrizione	Lunghezza	Valore	Note
Indirizzo fisico	1 byte	1 to F7 HEX (1 to 247)	
Codice funzione	1 byte	03 HEX	
Indirizzo iniziale	2 bytes	0000 to FFFF HEX	Ordine bytes: MSB, LSB
Quantità di registri (N word)	2 bytes	1 to 10 HEX (1 to 16)	Ordine bytes: MSB, LSB
CRC	2 bytes		

Frame di risposta (azione corretta)			
Descrizione	Lunghezza	Valore	Note
Indirizzo fisico	1 byte	1 to F7 HEX (1 to 247)	
Codice funzione	1 byte	03 HEX	
Quantità di byte richiesti	1 byte	N word * 2	
Valore del registro	N*2 bytes		Ordine bytes: MSB, LSB
CRC	2 bytes		

Frame di risposta (azione non corretta)			
Descrizione	Lunghezza	Valore	Note
Indirizzo fisico	1 byte	1 to F7 HEX (1 to 247)	Possibile eccezione: 01: funzione illegale 02: indirizzo dati illegale 03: valore dati illegale 04: guasto del dispositivo slave
Codice funzione	1 byte	83 HEX	
Codice di eccezione	1 byte	01, 02, 03, 04 (see note)	
CRC	2 bytes		



### Funzione 06 esadecimale (Scrittura di un singolo registro di mantenimento)

Questa funzione viene utilizzata per scrivere un singolo registro di mantenimento. Il frame di richiesta specifica l'indirizzo del registro (word) da scrivere e il suo contenuto. La risposta corretta è un'eco della richiesta, restituita dopo che il contenuto del registro è stato scritto.

Frame di richiesta			
Descrizione	Lunghezza	Valore	Note
Indirizzo fisico	1 byte	1 to F7 HEX (1 to 247)	
Codice funzione	1 byte	06 HEX	
Indirizzo iniziale	2 bytes	0000h to FFFF HEX	Ordine bytes: MSB, LSB
Valore del registro	2 bytes	0000h to FFFF HEX	Ordine bytes: MSB, LSB
CRC	2 bytes		

Frame di risposta (azione corretta)			
Descrizione	Lunghezza	Valore	Note
Indirizzo fisico	1 byte	1 to F7 HEX (1 to 247)	
Codice funzione	1 byte	06 HEX	
Indirizzo iniziale	2 bytes	0000h to FFFF HEX	Ordine bytes: MSB, LSB
Valore del registro	2 bytes	0000h to FFFF HEX	Ordine bytes: MSB, LSB
CRC	2 bytes		

Frame di risposta (azione non corretta)			
Descrizione	Lunghezza	Valore	Note
Indirizzo fisico	1 byte	1 to F7 HEX (1 to 247)	Possibile eccezione: 01: funzione illegale 02: indirizzo dati illegale 03: valore dati illegale 04: guasto del dispositivo slave
Codice funzione	1 byte	86 HEX	
Codice di eccezione	1 byte	01, 02, 03, 04 (see note)	
CRC	2 bytes		



### Funzione 10 esadecimale (Scrittura di registri multipli)

Questa funzione viene utilizzata per scrivere un blocco di registri contigui (massimo 2). I valori richiesti da scrivere sono specificati nel campo dati della richiesta. I dati sono impacchettati come due byte per registro.

La risposta corretta restituisce il codice di funzione, l'indirizzo di inizio e la quantità di registri scritti.

Frame di richiesta			
Descrizione	Lunghezza	Valore	Note
Indirizzo fisico	1 byte	1 to F7 HEX (1 to 247)	
Codice funzione	1 byte	10 HEX	
Indirizzo iniziale	2 bytes	0000 to FFFF HEX	Ordine bytes: MSB, LSB
Quantità di registri (N word)	2 bytes	0001 to 0078 HEX	Ordine bytes: MSB, LSB
Conteggio dei byte	1 byte	N word * 2	
Valore del registro	N * 2 bytes	value	Ordine bytes: MSB, LSB
CRC	2 bytes		

Frame di risposta (azione corretta)			
Descrizione	Lunghezza	Valore	Note
Indirizzo fisico	1 byte	1 to F7 HEX (1 to 247)	
Codice funzione	1 byte	10 HEX	
Indirizzo iniziale	2 bytes	0000 to FFFF HEX	Ordine bytes: MSB, LSB
Quantità di registri (N word)	2 bytes	0001 to 0078 HEX	Ordine bytes: MSB, LSB
CRC	2 bytes		

Frame di risposta (azione non corretta)			
Descrizione	Lunghezza	Valore	Note
Indirizzo fisico	1 byte	1 to F7 HEX (1 to 247)	Possibile eccezione: 01: funzione illegale 02: indirizzo dati illegale 03: valore dati illegale 04: guasto del dispositivo slave
Codice funzione	1 byte	90 HEX	
Codice di eccezione	1 byte	01, 02, 03, 04 (see note)	
CRC	2 bytes		



## REGISTRO "CONFIGURATION REGISTER" 40007

Questo registro a 16 bit regola le principali impostazioni di funzionamento della scheda.

Di seguito in dettaglio:

Impostazione	Valore	Dettaglio
TA in ingresso	xxxx xxxx xxxx xxx0	Ingresso in corrente (e.g. TA 5A)
	xxxx xxxx xxxx xxx1	Ingresso in tensione (e.g. TA 333 mV, Rogowski)
Metodo di calcolo per la potenza reattiva	xxxx xxxx xx0x xxxx	Metodo triangolare: questo metodo non misura la potenza reattiva, ma la calcola. È il metodo più usato negli energy meter
	xxxx xxxx xx1x xxxx	Metodo a sfasamento (Budeanu). Questo metodo misura la potenza reattiva. I valori di precisione dati sono relativi a questo metodo
Canale di lettura della frequenza	xxxx xxxx 0xxx xxxx	Canale di tensione
	xxxx xxxx 1xxx xxxx	Canale di corrente
Tipo di ingresso in tensione	xxxx xxx0 xxxx xxxx	Carico standard
	xxxx xxx1 xxxx xxxx	Tensione di ingresso di tipo PWM.
Salvataggio energia	xxxx xx0x xxxx xxxx	Salvataggio disabilitato
	xxxx xx1x xxxx xxxx	Salvataggio abilitato
Visualizzazione dati dinamici	xxx0 0xxx xxxx xxxx	Float
	xxx0 1xxx xxxx xxxx	Float invertiti
	xxx1 0xxx xxxx xxxx	interi * 100
	xxx1 1xxx xxxx xxxx	interi * 100 invertiti
Integratore	xx0x xxxx xxxx xxxx	Integratore disabilitato
	xx1x xxxx xxxx xxxx	Integratore abilitato per ingresso Rogowski
Comportamento uscita digitale	x0xx x0xx xxxx xxxx	In salita: contatto normalmente aperto
	x1xx x0xx xxxx xxxx	In discesa: contatto normalmente chiuso
	x0xx x1xx xxxx xxxx	A finestra: contatto chiuso tra le soglie
	x1xx x1xx xxxx xxxx	A finestra: contatto chiuso al di fuori delle soglie
Filtraggio misure	0xxx xxxx xxxx xxxx	Filtraggio disabilitato: misure meno stabili, ma aggiornamento più rapido
	1xxx xxxx xxxx xxxx	Filtraggio abilitato: misure più stabili, ma aggiornamento meno rapido



## MAPPA DEI REGISTRI

In **grassetto** i valori di default.

STANDARD VERSION
PLUS AND PRO VERSION
PRO VERSION

Address Modbus	Description	Register Type	R/W	Default
40001	Machine ID: 62 = QC-ENERGY-3T-STD 63 = QC-ENERGY-3T-PLUS 64 = QC-ENERGY-3T-PRO	UShort [16b]	R	
40002	Hardware (MSB) and Firmware (LSB) Revision of base board	UShort [16b]	R	
40003	Modbus address	UShort [16b]	R/W	1
40004	Modbus communication response delay (in machine cycles)	UShort [16b]	R/W	1
40005	Baudrate Value: 0 = 1200 1 = 2400 2 = 4800 <b>3 = 9600</b> 4 = 19200 5 = 38400 6 = 57600 7 = 115200	UShort [16b]	R/W	3
40006	Parity: <b>0 = NONE</b> 1 = ODD 2 = EVEN	UShort [16b]	R/W	0
40007	Measurement settings: bit[0]=Current transducer type <b>0 → Input 1A or 5A</b> 1 → Input 333 mV or Rogowski bit[1..2]= Connection 0 → Single phase 1 → Three phase: 3 wires, 2 CT (Aron) 2 → Three phase: 3 wires, 3 CT <b>3 → Three phase: 4 wires, 3 CT (with neutral)</b> bit[3]=FFT representation <b>0 → Absolute</b> 1 → Relative to the I1 value bit[5]=Reactive power calculation method 0 → Triangle method <b>1 → Budeanu</b> bit[7]=Frequency detection Channel <b>0 → Voltage</b> 1 → Current bit[8]=Voltage input type <b>0 → Normal load</b> 1 → PWM modulated input (Inverter Load) bit[9]=Energies data logging in flash 0 → Disabled <b>1 → Enabled</b> bit[11..12]= Measurement type <b>0 → Float</b> 1 → Float Swapped 2 → Hundreds (integer *100) 3 → Swapped hundreds (integer * 100 swapped) bit[13]=Integrator condition <b>0 → Integrator disabled</b> 1 → Integrator enabled (Rogowski input) bit[10, 14]= Digital output alarm type 0 = below threshold 1 = between thresholds <b>2 = above threshold</b> 3 = outside thresholds bit[15]=Measurement filtered <b>0 = Filtering disabled</b> 1 = Filtering enabled	UShort [16b]	R/W	16950
40009	Current transformer ratio CT ratio = primary current of transducer / secondary current (or voltage) of transducer / (number of turns - if any) <b>[see figure 3]</b> Example: current transducer QI-KCT-10-50/333 (50A primary, secondary 333mV output), no turns --> CT = 150,1501	Float [32b-LSW]	R/W	1
40011	Current transducer phase delay in [°] @ 50 Hz for accurate power calculation	Float [32b-LSW]	R/W	0



Address Modbus	Description	Register Type	R/W	Default																																																								
40013	Voltage transducer ratio M/N - Default 1.0 (Ex: 1000:100 = transducer_ratio = 10)	Float [32b-LSW]	R/W	1																																																								
40015	Voltage transducer phase delay in [°] @ 50 Hz for accurate power calculation	Float [32b-LSW]	R/W	0																																																								
40017	Voltage threshold cut-off: minimum threshold under which the instrument reads 0 independent from the input value	Float [32b-LSW]	R/W	0																																																								
40019	Current threshold cut-off: minimum threshold under which the instrument reads 0 independent from the input value	Float [32b-LSW]	R/W	0																																																								
40021	Power threshold cut-off: minimum threshold under which the instrument reads 0 independent from the input value (P, Q, and S)	Float [32b-LSW]	R/W	0																																																								
40023	Update interval for calculating the RMS. Valid for DC systems. [tenths of a second]	UShort [16b]	R/W	10																																																								
40024	Number of line zero-crossing for RMS calculation. Valid for AC systems. (example: 50 → if frequency is 50Hz, updated every 1s)	UShort [16b]	R/W	50																																																								
40025	Minute for Max demand calculation (0..45)	UShort [16b]	R/W	15																																																								
40026	Multiple alarms settings: bit[0] = Phase 1 threshold exceeded based on reg. 40007 bit[1] = Phase 2 threshold exceeded based on reg. 40007 bit[2] = Phase 3 threshold exceeded based on reg. 40007 bit[3] = phase 1 interruption bit[4] = phase 2 interruption bit[5] = phase 3 interruption bit[6] = Asymmetry voltage unbalance bit[7] = Phase sequence bit[15] = Enable multiple alarms in OR condition	UShort [16b]	R/W	0																																																								
40027	Seconds for average RMS: Seconds for the calculation of average RMS value (min 0 – max 30)	UShort [16b]	R/W	0																																																								
40028	Seconds for MAX RMS: Seconds for the calculation of MAX RMS value (min 1 – max 30). If the value is 0, then the absolute MAX RMS is given.	UShort [16b]	R/W	0																																																								
40029	Seconds for min RMS: Seconds for the calculation of min RMS value (min 1 – max 30). If the value is 0, then the absolute min RMS is given.	UShort [16b]	R/W	0																																																								
40030	Energy measurement unit factor: 0 = [Wh/10] 1 = [Wh] 2 = [kWh]	UShort [16b]	R/W	0																																																								
40031	Setpoint for Voltage Unbalance Alarm	Float [32b-LSW]	R/W	0																																																								
40033	Phase custom configuration (for customizing the current and voltage phase sequence): bit[0..2] = Voltage terminal settings (terminals 16,17,18) <table border="1" style="margin-left: 20px;"> <thead> <tr> <th>bit[2]</th> <th>bit[1]</th> <th>bit[0]</th> <th>phase sequence</th> </tr> </thead> <tbody> <tr><td>0</td><td>0</td><td>0</td><td>L1 - L2 - L3</td></tr> <tr><td>0</td><td>0</td><td>1</td><td>L3 - L1 - L2</td></tr> <tr><td>0</td><td>1</td><td>0</td><td>L2 - L3 - L1</td></tr> <tr><td>0</td><td>1</td><td>1</td><td>L1 - L3 - L2</td></tr> <tr><td>1</td><td>0</td><td>0</td><td>L3 - L2 - L1</td></tr> <tr><td>1</td><td>0</td><td>1</td><td>L2 - L1 - L3</td></tr> </tbody> </table> bit[3..5] = Current terminal settings (terminals 1-2, 3-4, 5-6) <table border="1" style="margin-left: 20px;"> <thead> <tr> <th>bit[5]</th> <th>bit[4]</th> <th>bit[3]</th> <th>current sequence</th> </tr> </thead> <tbody> <tr><td>0</td><td>0</td><td>0</td><td>I1 - I2 - I3</td></tr> <tr><td>0</td><td>0</td><td>1</td><td>I3 - I1 - I2</td></tr> <tr><td>0</td><td>1</td><td>0</td><td>I2 - I3 - I1</td></tr> <tr><td>0</td><td>1</td><td>1</td><td>I1 - I3 - I2</td></tr> <tr><td>1</td><td>0</td><td>0</td><td>I3 - I2 - I1</td></tr> <tr><td>1</td><td>0</td><td>1</td><td>I2 - I1 - I3</td></tr> </tbody> </table> bit[6,7,8] = Current direction I1, I2, I3 0 → Normal 1 → Inverse  bit[15] = Phase custom configuration 0 → Disable 1 → Enable	bit[2]	bit[1]	bit[0]	phase sequence	0	0	0	L1 - L2 - L3	0	0	1	L3 - L1 - L2	0	1	0	L2 - L3 - L1	0	1	1	L1 - L3 - L2	1	0	0	L3 - L2 - L1	1	0	1	L2 - L1 - L3	bit[5]	bit[4]	bit[3]	current sequence	0	0	0	I1 - I2 - I3	0	0	1	I3 - I1 - I2	0	1	0	I2 - I3 - I1	0	1	1	I1 - I3 - I2	1	0	0	I3 - I2 - I1	1	0	1	I2 - I1 - I3	UShort [16b]	R/W	0
bit[2]	bit[1]	bit[0]	phase sequence																																																									
0	0	0	L1 - L2 - L3																																																									
0	0	1	L3 - L1 - L2																																																									
0	1	0	L2 - L3 - L1																																																									
0	1	1	L1 - L3 - L2																																																									
1	0	0	L3 - L2 - L1																																																									
1	0	1	L2 - L1 - L3																																																									
bit[5]	bit[4]	bit[3]	current sequence																																																									
0	0	0	I1 - I2 - I3																																																									
0	0	1	I3 - I1 - I2																																																									
0	1	0	I2 - I3 - I1																																																									
0	1	1	I1 - I3 - I2																																																									
1	0	0	I3 - I2 - I1																																																									
1	0	1	I2 - I1 - I3																																																									
40035	delay in ms for Alarm trigger	UShort [16b]	R/W	0																																																								
40036	Address of the magnitude to be monitored with the alarm (ex. 40359 for RMS star voltage L1-N, 40361 RMS star voltage L1-N, etc...)	UShort [16b]	R/W	40361																																																								
40037	Alarm threshold for “above” and “below” types OR first alarm threshold for “within threshold” and “Outside threshold” types	Float [32b-LSW]	R/W	0																																																								
40039	Alarm Hysteresis	Float [32b-LSW]	R/W	1																																																								
40041	Second alarm threshold for “within threshold” and “Outside threshold” types	Float [32b-LSW]	R/W																																																									
40043	Threshold for Power exceeding’s monitoring	Float [32b-LSW]	R/W	0																																																								
40045	Nominal Star Voltage for Sag, Swell, Interruption monitoring [V]	Float [32b-LSW]	R/W	230																																																								



Address Modbus	Description	Register Type	R/W	Default
40047	Sag percentage level: Percentage of Nominal Star Voltage under which a Sag event is generated (default 0.9 = 90 %); must be over Interruption percentage level register	Float [32b-LSW]	R/W	0,9
40049	Swell percentage level: Percentage of Nominal Star Voltage over which a Swell event is generated (default 1.1 = 110 %)	Float [32b-LSW]	R/W	1,1
40051	Interruption percentage level: Percentage over Nominal Star Voltage under which an Interruption event is generated (default 0.1 = 10 %)	Float [32b-LSW]	R/W	0,1
40053	Minimum duration (cutoff value) of Sag, Swell or Interruption events to be displayed and saved [ms]	UShort [16b]	R	0
40054	Number pulses generated on terminal #17 every kWh according to energy measurement [unit factor based on selection of reg. 40030]	UShort [16b]	R	1
40197	S/N part1	UShort [16b]	R	
40198	S/N part2	UShort [16b]	R	
40199	S/N part3	UShort [16b]	R	
40219	Display HW version of display board	Float [32b-LSW]	R	
40221	Display FW version of display board	Float [32b-LSW]	R	
40239	Status: bit[0] = flash settings error bit[1] = flash calibration error bit[2] = Current I1 Over Range bit[3] = Current I1 Under Range bit[4] = Current I2 Over Range bit[5] = Current I2 Under Range bit[6] = Current I3 Over Range bit[7] = Current I3 Under Range bit[8] = Current V1 Over Range bit[9] = Current V1 Under Range bit[10] = Current V2 Over Range bit[11] = Current V2 Under Range bit[12] = Current V3 Over Range bit[13] = Current V3 Under Range bit[14] = Zero crossing detecting bit[15] = Switch open bit[16] = Wh storing error bit[19] = Alarm triggered bit[28] = Reactive power (type inductive) bit[29] = Reactive power (type inductive) bit[30] = Reactive power (type inductive)	ULong [32b-LSW]	R	
40244	Command: 0xC1C0 = Flash settings save command 0xC1A0 = Reboot command 0xBABA = Save energy command - See note <sup>1</sup> 0xB000 = Enter Bootloader command 0xDAAA = Close Switch command (alarm switch) 0xDAAB = Open Switch command (alarm switch) 0xE000 = Read previous SAG event in EEprom 0xE001 = Read previous SWELL event in EEprom 0xE002 = Read previous INTERRUPTION event in EEprom 0xE100 = Reset SAG events in EEprom 0xE101 = Reset SWELL events in EEprom 0xE102 = Reset INTERRUPTION events in EEprom 0xF000 = Reset MAX Demand registers command	UShort [16b]	R/W	
40245	Active energy line 1 [unit based on reg. 40030] - See note <sup>1</sup>	Int [64b-LSW]	R/W	
40249	Active energy line 2 [Unit based on reg. 40030] - See note <sup>1</sup>	Int [64b-LSW]	R/W	
40253	Active energy line 3 [Unit based on reg. 40030] - See note <sup>1</sup>	Int [64b-LSW]	R/W	
40257	Active energy three phase [Unit based on reg. 40030]	Int [64b-LSW]	R	
40261	Positive Active energy line 1 [Unit based on reg. 40030] - See note <sup>1</sup>	Int [64b-LSW]	R/W	
40265	Positive Active energy line 2 [Unit based on reg. 40030] - See note <sup>1</sup>	Int [64b-LSW]	R/W	
40269	Positive Active energy line 3 [Unit based on reg. 40030] - See note <sup>1</sup>	Int [64b-LSW]	R/W	
40273	Positive Active energy three phase [Unit based on reg. 40030]	Int [64b-LSW]	R	
40277	Negative Active energy line 1 [Unit based on reg. 40030] - See note <sup>1</sup>	Int [64b-LSW]	R/W	
40281	Negative Active energy line 2 [Unit based on reg. 40030] - See note <sup>1</sup>	Int [64b-LSW]	R/W	
40285	Negative Active energy line 3 [Unit based on reg. 40030] - See note <sup>1</sup>	Int [64b-LSW]	R/W	
40289	Negative Active energy three phase [Unit based on reg. 40030]	Int [64b-LSW]	R	
40293	Reactive energy line 1 [Unit based on reg. 40030] - See note <sup>1</sup>	Int [64b-LSW]	R/W	
40297	Reactive energy line 2 [Unit based on reg. 40030] - See note <sup>1</sup>	Int [64b-LSW]	R/W	
40301	Reactive energy line 3 [Unit based on reg. 40030] - See note <sup>1</sup>	Int [64b-LSW]	R/W	
40305	Reactive energy three phase [Unit based on reg. 40030]	Int [64b-LSW]	R	
40309	Inductive Reactive energy line 1 [Unit based on reg. 40030] - See note <sup>1</sup>	Int [64b-LSW]	R/W	
40313	Inductive Reactive energy line 2 [Unit based on reg. 40030] - See note <sup>1</sup>	Int [64b-LSW]	R/W	
40317	Inductive Reactive energy line 3 [Unit based on reg. 40030] - See note <sup>1</sup>	Int [64b-LSW]	R/W	
40321	Inductive Reactive energy three phase [Unit based on reg. 40030]	Int [64b-LSW]	R	



Address Modbus	Description	Register Type	R/W	Default
40325	Capacitive Reactive energy line 1 [Unit based on reg. 40030] - See note <sup>1</sup>	Int [64b-LSW]	R/W	
40329	Capacitive Reactive energy line 2 [Unit based on reg. 40030] - See note <sup>1</sup>	Int [64b-LSW]	R/W	
40333	Capacitive Reactive energy line 3 [Unit based on reg. 40030] - See note <sup>1</sup>	Int [64b-LSW]	R/W	
40337	Capacitive Reactive energy three phase [Unit based on reg. 40030]	Int [64b-LSW]	R	
40341	Apparent energy line 1 [Unit based on reg. 40030] - See note <sup>1</sup>	Int [64b-LSW]	R/W	
40345	Apparent energy line 2 [Unit based on reg. 40030] - See note <sup>1</sup>	Int [64b-LSW]	R/W	
40349	Apparent energy line 3 [Unit based on reg. 40030] - See note <sup>1</sup>	Int [64b-LSW]	R/W	
40353	Apparent energy three phase [Unit based on reg. 40030]	Int [64b-LSW]	R	
40357	Events' counter of energy stored in flash (every 20 seconds)	ULong [32b-LSW]	R	
40359	RMS star voltage L1-N [V]	Float [32b-LSW]	R	
40361	RMS star voltage L2-N [V]	Float [32b-LSW]	R	
40363	RMS star voltage L3-N [V]	Float [32b-LSW]	R	
40365	RMS star avg value voltage [V]	Float [32b-LSW]	R	
40367	RMS line voltage L1-L2 [V]	Float [32b-LSW]	R	
40369	RMS line voltage L2-L3 [V]	Float [32b-LSW]	R	
40371	RMS line voltage L3-L1 [V]	Float [32b-LSW]	R	
40373	RMS line avg value voltage [V]	Float [32b-LSW]	R	
40375	RMS line current L1 [A]	Float [32b-LSW]	R	
40377	RMS line current L2 [A]	Float [32b-LSW]	R	
40379	RMS line current L3 [A]	Float [32b-LSW]	R	
40381	Calculated RMS line current N [A] (in case of 1 or 2 TA configuration, I <sub>N</sub> set = 0)	Float [32b-LSW]	R	
40383	RMS avg value current [A] (excluding neutral current I <sub>N</sub> )	Float [32b-LSW]	R	
40385	RMS active power line 1 [W]	Float [32b-LSW]	R	
40387	RMS active power line 2 [W]	Float [32b-LSW]	R	
40389	RMS active power line 3 [W]	Float [32b-LSW]	R	
40391	RMS sum active power [W]	Float [32b-LSW]	R	
40393	RMS reactive power line 1 [VAR]	Float [32b-LSW]	R	
40395	RMS reactive power line 2 [VAR]	Float [32b-LSW]	R	
40397	RMS reactive power line 3 [VAR]	Float [32b-LSW]	R	
40399	RMS sum reactive power [VAR]	Float [32b-LSW]	R	
40401	RMS apparent power line 1 [VA]	Float [32b-LSW]	R	
40403	RMS apparent power line 2 [VA]	Float [32b-LSW]	R	
40405	RMS apparent power line 3 [VA]	Float [32b-LSW]	R	
40407	RMS sum apparent power [VA]	Float [32b-LSW]	R	
40409	Power Factor line 1	Float [32b-LSW]	R	
40411	Power Factor line 2	Float [32b-LSW]	R	
40413	Power Factor line 3	Float [32b-LSW]	R	
40415	Three Phase Power Factor	Float [32b-LSW]	R	
40417	Crest Factor line 1	Float [32b-LSW]	R	
40419	Crest Factor line 2	Float [32b-LSW]	R	
40421	Crest Factor line 3	Float [32b-LSW]	R	
40423	Crest Factor Neutral	Float [32b-LSW]	R	
40425	Frequency [Hz]	Float [32b-LSW]	R	
40427	Star voltage L1-N peak [V]	Float [32b-LSW]	R	
40429	Star voltage L2-N peak [V]	Float [32b-LSW]	R	
40431	Star voltage L3-N peak [V]	Float [32b-LSW]	R	
40433	Line voltage L1-L2 peak [V]	Float [32b-LSW]	R	
40435	Line voltage L2-L3 peak [V]	Float [32b-LSW]	R	
40437	Line voltage L3-L1 peak [V]	Float [32b-LSW]	R	
40439	L1 current peak [A]	Float [32b-LSW]	R	
40441	L2 current peak [A]	Float [32b-LSW]	R	
40443	L3 current peak [A]	Float [32b-LSW]	R	
40445	N current peak [A]	Float [32b-LSW]	R	
40467	Distortion Power Factor line 1 (+ inductive, - capacitive)	Float [32b-LSW]	R	
40469	Distortion Power Factor line 2 (+ inductive, - capacitive)	Float [32b-LSW]	R	
40471	Distortion Power Factor line 3 (+ inductive, - capacitive)	Float [32b-LSW]	R	
40473	Neutral Distortion Power Factor (+ inductive, - capacitive)	Float [32b-LSW]	R	
40475	Tangent $\phi$ line 1 (+ inductive, - capacitive)	Float [32b-LSW]	R	
40477	Tangent $\phi$ line 2 (+ inductive, - capacitive)	Float [32b-LSW]	R	
40479	Tangent $\phi$ line 3 (+ inductive, - capacitive)	Float [32b-LSW]	R	
40481	Average Tangent $\phi$ (+ inductive, - capacitive)	Float [32b-LSW]	R	



Address Modbus	Description	Register Type	R/W	Default
40483	Motor control   Direction of rotation: 0 = clockwise (L1, L2, L3) 1 = anti-clockwise (L1, L3, L2)	Float [32b-LSW]	R	
40485	Internal Temperature [°C]	Float [32b-LSW]	R	
40487	Star voltage L1_N RMS average [V] over "Seconds for average RMS (reg. 40027)"	Float [32b-LSW]	R	
40489	Star voltage L1_N MAX RMS [V] over last "Seconds for MAX RMS (reg. 40028)"	Float [32b-LSW]	R	
40491	Star voltage L1_N Min RMS [V] over last "Seconds for min RMS (reg. 40029)"	Float [32b-LSW]	R	
40493	Star voltage L2_N RMS average [V] over "Seconds for average RMS (reg. 40027)"	Float [32b-LSW]	R	
40495	Star voltage L2_N MAX RMS [V] over last "Seconds for MAX RMS (reg. 40028)"	Float [32b-LSW]	R	
40497	Star voltage L2_N Min RMS [V] over last "Seconds for min RMS (reg. 40029)"	Float [32b-LSW]	R	
40499	Star voltage L3_N RMS average [V] over "Seconds for average RMS (reg. 40027)"	Float [32b-LSW]	R	
40501	Star voltage L3_N MAX RMS [V] over last "Seconds for MAX RMS (reg. 40028)"	Float [32b-LSW]	R	
40503	Star voltage L3_N Min RMS [V] over last "Seconds for min RMS (reg. 40029)"	Float [32b-LSW]	R	
40505	Star voltage AVG RMS average [V] over "Seconds for average RMS (reg. 40027)"	Float [32b-LSW]	R	
40507	Star voltage AVG MAX RMS [V] over last "Seconds for MAX RMS (reg. 40028)"	Float [32b-LSW]	R	
40509	Star voltage AVG Min RMS [V] over last "Seconds for min RMS (reg. 40029)"	Float [32b-LSW]	R	
40511	Line voltage L1-L2 RMS average [V] over "Seconds for average RMS (reg. 40027)"	Float [32b-LSW]	R	
40513	Line voltage L1-L2 MAX RMS [V] over last "Seconds for MAX RMS (reg. 40028)"	Float [32b-LSW]	R	
40515	Line voltage L1-L2 Min RMS [V] over last "Seconds for min RMS (reg. 40029)"	Float [32b-LSW]	R	
40517	Line voltage L2-L3 RMS average [V] over "Seconds for average RMS (reg. 40027)"	Float [32b-LSW]	R	
40519	Line voltage L2-L3 MAX RMS [V] over last "Seconds for MAX RMS (reg. 40028)"	Float [32b-LSW]	R	
40521	Line voltage L2-L3 Min RMS [V] over last "Seconds for min RMS (reg. 40029)"	Float [32b-LSW]	R	
40523	Line voltage L3-L1 RMS average [V] over "Seconds for average RMS (reg. 40027)"	Float [32b-LSW]	R	
40525	Line voltage L3-L1 MAX RMS [V] over last "Seconds for MAX RMS (reg. 40028)"	Float [32b-LSW]	R	
40527	Line voltage L3-L1 Min RMS [V] over last "Seconds for min RMS (reg. 40029)"	Float [32b-LSW]	R	
40529	Line voltage AVG RMS average [V] over "Seconds for average RMS (reg. 40027)"	Float [32b-LSW]	R	
40531	Line voltage AVG MAX RMS [V] over last "Seconds for MAX RMS (reg. 40028)"	Float [32b-LSW]	R	
40533	Line voltage AVG Min RMS [V] over last "Seconds for min RMS (reg. 40029)"	Float [32b-LSW]	R	
40535	L1 RMS average current [A] over "Seconds for average RMS (reg. 40027)"	Float [32b-LSW]	R	
40537	L1 MAX RMS current [A] over last "Seconds for MAX RMS (reg. 40028)"	Float [32b-LSW]	R	
40539	L1 Min RMS current [A] over last "Seconds for min RMS (reg. 40029)"	Float [32b-LSW]	R	
40541	L2 RMS average current [A] over "Seconds for average RMS (reg. 40027)"	Float [32b-LSW]	R	
40543	L2 MAX RMS current [A] over last "Seconds for MAX RMS (reg. 40028)"	Float [32b-LSW]	R	
40545	L2 Min RMS current [A] over last "Seconds for min RMS (reg. 40029)"	Float [32b-LSW]	R	
40547	L3 RMS average current [A] over "Seconds for average RMS (reg. 40027)"	Float [32b-LSW]	R	
40549	L3 MAX RMS current [A] over last "Seconds for MAX RMS (reg. 40028)"	Float [32b-LSW]	R	
40551	L3 Min RMS current [A] over last "Seconds for min RMS (reg. 40029)"	Float [32b-LSW]	R	
40553	N RMS average current [A] over "Seconds for average RMS (reg. 40027)"	Float [32b-LSW]	R	
40555	N MAX RMS current [A] over last "Seconds for MAX RMS (reg. 40028)"	Float [32b-LSW]	R	
40557	N Min RMS current [A] over last "Seconds for min RMS (reg. 40029)"	Float [32b-LSW]	R	
40559	I_AVG RMS average current [A] over "Seconds for average RMS (reg. 40027)"	Float [32b-LSW]	R	
40561	I_AVG MAX RMS current [A] over last "Seconds for MAX RMS (reg. 40028)"	Float [32b-LSW]	R	
40563	I_AVG Min RMS current [A] over last "Seconds for min RMS (reg. 40029)"	Float [32b-LSW]	R	
40565	P1 RMS average [W] over "Seconds for average RMS (reg. 40027)"	Float [32b-LSW]	R	
40567	P1 MAX RMS [W] over last "Seconds for MAX RMS (reg. 40028)"	Float [32b-LSW]	R	
40569	P1 Min RMS [W] over last "Seconds for min RMS (reg. 40029)"	Float [32b-LSW]	R	
40571	P2 RMS average [W] over "Seconds for average RMS (reg. 40027)"	Float [32b-LSW]	R	
40573	P2 MAX RMS [W] over last "Seconds for MAX RMS (reg. 40028)"	Float [32b-LSW]	R	
40575	P2 Min RMS [W] over last "Seconds for min RMS (reg. 40029)"	Float [32b-LSW]	R	
40577	P3 RMS average [W] over "Seconds for average RMS (reg. 40027)"	Float [32b-LSW]	R	
40579	P3 MAX RMS [W] over last "Seconds for MAX RMS (reg. 40028)"	Float [32b-LSW]	R	
40581	P3 Min RMS [W] over last "Seconds for min RMS (reg. 40029)"	Float [32b-LSW]	R	
40583	P_SUM RMS average [W] over "Seconds for average RMS (reg. 40027)"	Float [32b-LSW]	R	
40585	P_SUM MAX RMS [W] over last "Seconds for MAX RMS (reg. 40028)"	Float [32b-LSW]	R	
40587	P_SUM Min RMS [W] over last "Seconds for min RMS (reg. 40029)"	Float [32b-LSW]	R	
40589	Q1 RMS average [VAR] over "Seconds for average RMS (reg. 40027)"	Float [32b-LSW]	R	
40591	Q1 MAX RMS [VAR] over last "Seconds for MAX RMS (reg. 40028)"	Float [32b-LSW]	R	
40593	Q1 Min RMS [VAR] over last "Seconds for min RMS (reg. 40029)"	Float [32b-LSW]	R	
40595	Q2 RMS average [VAR] over "Seconds for average RMS (reg. 40027)"	Float [32b-LSW]	R	
40597	Q2 MAX RMS [VAR] over last "Seconds for MAX RMS (reg. 40028)"	Float [32b-LSW]	R	
40599	Q2 Min RMS [VAR] over last "Seconds for min RMS (reg. 40029)"	Float [32b-LSW]	R	
40601	Q3 RMS average [VAR] over "Seconds for average RMS (reg. 40027)"	Float [32b-LSW]	R	
40603	Q3 MAX RMS [VAR] over last "Seconds for MAX RMS (reg. 40028)"	Float [32b-LSW]	R	
40605	Q3 Min RMS [VAR] over last "Seconds for min RMS (reg. 40029)"	Float [32b-LSW]	R	



Address Modbus	Description	Register Type	R/W	Default
40607	Q_SUM RMS average [VAR] over "Seconds for average RMS (reg. 40027)"	Float [32b-LSW]	R	
40609	Q_SUM MAX RMS [VAR] over last "Seconds for MAX RMS (reg. 40028)"	Float [32b-LSW]	R	
40611	Q_SUM Min RMS [VAR] over last "Seconds for min RMS (reg. 40029)"	Float [32b-LSW]	R	
40613	S1 RMS average [VA] over "Seconds for average RMS (reg. 40027)"	Float [32b-LSW]	R	
40615	S1 MAX RMS [VA] over last "Seconds for MAX RMS (reg. 40028)"	Float [32b-LSW]	R	
40617	S1 Min RMS [VA] over last "Seconds for min RMS (reg. 40029)"	Float [32b-LSW]	R	
40619	S2 RMS average [VA] over "Seconds for average RMS (reg. 40027)"	Float [32b-LSW]	R	
40621	S2 MAX RMS [VA] over last "Seconds for MAX RMS (reg. 40028)"	Float [32b-LSW]	R	
40623	S2 Min RMS [VA] over last "Seconds for min RMS (reg. 40029)"	Float [32b-LSW]	R	
40625	S3 RMS average [VA] over "Seconds for average RMS (reg. 40027)"	Float [32b-LSW]	R	
40627	S3 MAX RMS [VA] over last "Seconds for MAX RMS (reg. 40028)"	Float [32b-LSW]	R	
40629	S3 Min RMS [VA] over last "Seconds for min RMS (reg. 40029)"	Float [32b-LSW]	R	
40631	S_SUM RMS average [VA] over "Seconds for average RMS (reg. 40027)"	Float [32b-LSW]	R	
40633	S_SUM MAX RMS [VA] over last "Seconds for MAX RMS (reg. 40028)"	Float [32b-LSW]	R	
40635	S_SUM Min RMS [VA] over last "Seconds for min RMS (reg. 40029)"	Float [32b-LSW]	R	
40637	PF1 RMS average over "Seconds for average RMS (reg. 40027)"	Float [32b-LSW]	R	
40639	PF1 MAX RMS over last "Seconds for MAX RMS (reg. 40028)"	Float [32b-LSW]	R	
40641	PF1 Min RMS over last "Seconds for min RMS (reg. 40029)"	Float [32b-LSW]	R	
40643	PF2 RMS average over "Seconds for average RMS (reg. 40027)"	Float [32b-LSW]	R	
40645	PF2 MAX RMS over last "Seconds for MAX RMS (reg. 40028)"	Float [32b-LSW]	R	
40647	PF2 Min RMS over last "Seconds for min RMS (reg. 40029)"	Float [32b-LSW]	R	
40649	PF3 RMS average over "Seconds for average RMS (reg. 40027)"	Float [32b-LSW]	R	
40651	PF3 MAX RMS over last "Seconds for MAX RMS (reg. 40028)"	Float [32b-LSW]	R	
40653	PF3 Min RMS over last "Seconds for min RMS (reg. 40029)"	Float [32b-LSW]	R	
40655	PF_SUM RMS average over "Seconds for average RMS (reg. 40027)"	Float [32b-LSW]	R	
40657	PF_SUM MAX RMS over last "Seconds for MAX RMS (reg. 40028)"	Float [32b-LSW]	R	
40659	PF_SUM Min RMS over last "Seconds for min RMS (reg. 40029)"	Float [32b-LSW]	R	
40661	Time above threshold specified in reg. 40043 for Active Power P1 [min]	Float [32b-LSW]	R	
40663	Time above threshold specified in reg. 40043 for Active Power P2 [min]	Float [32b-LSW]	R	
40665	Time above threshold specified in reg. 40043 for Active Power P3 [min]	Float [32b-LSW]	R	
40667	Time above threshold specified in reg. 40043 for Active Power P_SUM [min]	Float [32b-LSW]	R	
40669	Max Demand over minute_for_Max_demand for P1 for current month	Float [32b-LSW]	R	
40671	Max Demand over minute_for_Max_demand for P2 for current month	Float [32b-LSW]	R	
40673	Max Demand over minute_for_Max_demand for P3 for current month	Float [32b-LSW]	R	
40675	Max Demand over minute_for_Max_demand for P three phase for current month	Float [32b-LSW]	R	
40677	Time at which arises Max Demand over minute_for_Max_demand for P1 for current month (month   day   hour   minutes)	ULong [32b-LSW]	R	
40679	Time at which arises Max Demand over minute_for_Max_demand for P2 for current month (month   day   hour   minutes)	ULong [32b-LSW]	R	
40681	Time at which arises Max Demand over minute_for_Max_demand for P3 for current month (month   day   hour   minutes)	ULong [32b-LSW]	R	
40683	Time at which arises Max Demand over minute_for_Max_demand for P three phase for current month (month   day   hour   minutes)	ULong [32b-LSW]	R	
40685	K-factor for I1, see IEEE Standard 1100-1992	Float [32b-LSW]	R	
40687	K-factor for I2, see IEEE Standard 1100-1992	Float [32b-LSW]	R	
40689	K-factor for I3, see IEEE Standard 1100-1992	Float [32b-LSW]	R	
40691	RTC: year (2000-2099)	UShort [16b]	R/W	
40692	RTC: month (1-12)	UShort [16b]	R/W	
40693	RTC: day month (1-31)	UShort [16b]	R/W	
40694	RTC: hour (0-23)	UShort [16b]	R/W	
40695	RTC: minute (0-59)	UShort [16b]	R/W	
40696	RTC: second (0-59)	UShort [16b]	R/W	
40697	THD Star Voltage L1	Float [32b-LSW]	R	
40699	THD Star Voltage L2	Float [32b-LSW]	R	
40701	THD Star Voltage L3	Float [32b-LSW]	R	
40703	THD Line Voltage L1-L2	Float [32b-LSW]	R	
40705	THD Line Voltage L2-L3	Float [32b-LSW]	R	
40707	THD Line Voltage L3-L1	Float [32b-LSW]	R	
40709	THD Line Current L1	Float [32b-LSW]	R	
40711	THD Line Current L2	Float [32b-LSW]	R	
40713	THD Line Current L3	Float [32b-LSW]	R	
40715	THD Neutral Current	Float [32b-LSW]	R	
40717	TDD Line Current L1	Float [32b-LSW]	R	
40719	TDD Line Current L2	Float [32b-LSW]	R	



Address Modbus	Description	Register Type	R/W	Default
40721	TDD Line Current L3	Float [32b-LSW]	R	
40723	Voltage Unbalance of the three phase system	Float [32b-LSW]	R	
40737	Star Voltage L1-N Harmonic #0	Float [32b-LSW]	R	
40739	Star Voltage L1-N Harmonic #1	Float [32b-LSW]	R	
40741	Star Voltage L1-N Harmonic #2	Float [32b-LSW]	R	
40743	Star Voltage L1-N Harmonic #3	Float [32b-LSW]	R	
40745	Star Voltage L1-N Harmonic #4	Float [32b-LSW]	R	
40747	Star Voltage L1-N Harmonic #5	Float [32b-LSW]	R	
40749	Star Voltage L1-N Harmonic #6	Float [32b-LSW]	R	
40751	Star Voltage L1-N Harmonic #7	Float [32b-LSW]	R	
40753	Star Voltage L1-N Harmonic #8	Float [32b-LSW]	R	
40755	Star Voltage L1-N Harmonic #9	Float [32b-LSW]	R	
40757	Star Voltage L1-N Harmonic #10	Float [32b-LSW]	R	
40759	Star Voltage L1-N Harmonic #11	Float [32b-LSW]	R	
40761	Star Voltage L1-N Harmonic #12	Float [32b-LSW]	R	
40763	Star Voltage L1-N Harmonic #13	Float [32b-LSW]	R	
40765	Star Voltage L1-N Harmonic #14	Float [32b-LSW]	R	
40767	Star Voltage L1-N Harmonic #15	Float [32b-LSW]	R	
40769	Star Voltage L1-N Harmonic #16	Float [32b-LSW]	R	
40771	Star Voltage L1-N Harmonic #17	Float [32b-LSW]	R	
40773	Star Voltage L1-N Harmonic #18	Float [32b-LSW]	R	
40775	Star Voltage L1-N Harmonic #19	Float [32b-LSW]	R	
40777	Star Voltage L1-N Harmonic #20	Float [32b-LSW]	R	
40779	Star Voltage L1-N Harmonic #21	Float [32b-LSW]	R	
40781	Star Voltage L1-N Harmonic #22	Float [32b-LSW]	R	
40783	Star Voltage L1-N Harmonic #23	Float [32b-LSW]	R	
40785	Star Voltage L1-N Harmonic #24	Float [32b-LSW]	R	
40787	Star Voltage L1-N Harmonic #25	Float [32b-LSW]	R	
40789	Star Voltage L1-N Harmonic #26	Float [32b-LSW]	R	
40791	Star Voltage L1-N Harmonic #27	Float [32b-LSW]	R	
40793	Star Voltage L1-N Harmonic #28	Float [32b-LSW]	R	
40795	Star Voltage L1-N Harmonic #29	Float [32b-LSW]	R	
40797	Star Voltage L1-N Harmonic #30	Float [32b-LSW]	R	
40799	Star Voltage L1-N Harmonic #31	Float [32b-LSW]	R	
40801	Star Voltage L1-N Harmonic #32	Float [32b-LSW]	R	
40803	Star Voltage L1-N Harmonic #33	Float [32b-LSW]	R	
40805	Star Voltage L1-N Harmonic #34	Float [32b-LSW]	R	
40807	Star Voltage L1-N Harmonic #35	Float [32b-LSW]	R	
40809	Star Voltage L1-N Harmonic #36	Float [32b-LSW]	R	
40811	Star Voltage L1-N Harmonic #37	Float [32b-LSW]	R	
40813	Star Voltage L1-N Harmonic #38	Float [32b-LSW]	R	
40815	Star Voltage L1-N Harmonic #39	Float [32b-LSW]	R	
40817	Star Voltage L1-N Harmonic #40	Float [32b-LSW]	R	
40819	Star Voltage L1-N Harmonic #41	Float [32b-LSW]	R	
40821	Star Voltage L1-N Harmonic #42	Float [32b-LSW]	R	
40823	Star Voltage L1-N Harmonic #43	Float [32b-LSW]	R	
40825	Star Voltage L1-N Harmonic #44	Float [32b-LSW]	R	
40827	Star Voltage L1-N Harmonic #45	Float [32b-LSW]	R	
40829	Star Voltage L1-N Harmonic #46	Float [32b-LSW]	R	
40831	Star Voltage L1-N Harmonic #47	Float [32b-LSW]	R	
40833	Star Voltage L1-N Harmonic #48	Float [32b-LSW]	R	
40835	Star Voltage L1-N Harmonic #49	Float [32b-LSW]	R	
40837	Star Voltage L1-N Harmonic #50	Float [32b-LSW]	R	
40839	Star Voltage L1-N Harmonic #51	Float [32b-LSW]	R	
40841	Star Voltage L1-N Harmonic #52	Float [32b-LSW]	R	
40843	Star Voltage L1-N Harmonic #53	Float [32b-LSW]	R	
40845	Star Voltage L1-N Harmonic #54	Float [32b-LSW]	R	
40847	Star Voltage L1-N Harmonic #55	Float [32b-LSW]	R	
40849	Star Voltage L1-N Harmonic #56	Float [32b-LSW]	R	
40851	Star Voltage L1-N Harmonic #57	Float [32b-LSW]	R	
40853	Star Voltage L1-N Harmonic #58	Float [32b-LSW]	R	
40855	Star Voltage L1-N Harmonic #59	Float [32b-LSW]	R	
40857	Star Voltage L1-N Harmonic #60	Float [32b-LSW]	R	



Address Modbus	Description	Register Type	R/W	Default
40859	Star Voltage L1-N Harmonic #61	Float [32b-LSW]	R	
40861	Star Voltage L1-N Harmonic #62	Float [32b-LSW]	R	
40863	Star Voltage L1-N Harmonic #63	Float [32b-LSW]	R	
40865	Star Voltage L2-N Harmonic #0	Float [32b-LSW]	R	
40867	Star Voltage L2-N Harmonic #1	Float [32b-LSW]	R	
40869	Star Voltage L2-N Harmonic #2	Float [32b-LSW]	R	
40871	Star Voltage L2-N Harmonic #3	Float [32b-LSW]	R	
40873	Star Voltage L2-N Harmonic #4	Float [32b-LSW]	R	
40875	Star Voltage L2-N Harmonic #5	Float [32b-LSW]	R	
40877	Star Voltage L2-N Harmonic #6	Float [32b-LSW]	R	
40879	Star Voltage L2-N Harmonic #7	Float [32b-LSW]	R	
40881	Star Voltage L2-N Harmonic #8	Float [32b-LSW]	R	
40883	Star Voltage L2-N Harmonic #9	Float [32b-LSW]	R	
40885	Star Voltage L2-N Harmonic #10	Float [32b-LSW]	R	
40887	Star Voltage L2-N Harmonic #11	Float [32b-LSW]	R	
40889	Star Voltage L2-N Harmonic #12	Float [32b-LSW]	R	
40891	Star Voltage L2-N Harmonic #13	Float [32b-LSW]	R	
40893	Star Voltage L2-N Harmonic #14	Float [32b-LSW]	R	
40895	Star Voltage L2-N Harmonic #15	Float [32b-LSW]	R	
40897	Star Voltage L2-N Harmonic #16	Float [32b-LSW]	R	
40899	Star Voltage L2-N Harmonic #17	Float [32b-LSW]	R	
40901	Star Voltage L2-N Harmonic #18	Float [32b-LSW]	R	
40903	Star Voltage L2-N Harmonic #19	Float [32b-LSW]	R	
40905	Star Voltage L2-N Harmonic #20	Float [32b-LSW]	R	
40907	Star Voltage L2-N Harmonic #21	Float [32b-LSW]	R	
40909	Star Voltage L2-N Harmonic #22	Float [32b-LSW]	R	
40911	Star Voltage L2-N Harmonic #23	Float [32b-LSW]	R	
40913	Star Voltage L2-N Harmonic #24	Float [32b-LSW]	R	
40915	Star Voltage L2-N Harmonic #25	Float [32b-LSW]	R	
40917	Star Voltage L2-N Harmonic #26	Float [32b-LSW]	R	
40919	Star Voltage L2-N Harmonic #27	Float [32b-LSW]	R	
40921	Star Voltage L2-N Harmonic #28	Float [32b-LSW]	R	
40923	Star Voltage L2-N Harmonic #29	Float [32b-LSW]	R	
40925	Star Voltage L2-N Harmonic #30	Float [32b-LSW]	R	
40927	Star Voltage L2-N Harmonic #31	Float [32b-LSW]	R	
40929	Star Voltage L2-N Harmonic #32	Float [32b-LSW]	R	
40931	Star Voltage L2-N Harmonic #33	Float [32b-LSW]	R	
40933	Star Voltage L2-N Harmonic #34	Float [32b-LSW]	R	
40935	Star Voltage L2-N Harmonic #35	Float [32b-LSW]	R	
40937	Star Voltage L2-N Harmonic #36	Float [32b-LSW]	R	
40939	Star Voltage L2-N Harmonic #37	Float [32b-LSW]	R	
40941	Star Voltage L2-N Harmonic #38	Float [32b-LSW]	R	
40943	Star Voltage L2-N Harmonic #39	Float [32b-LSW]	R	
40945	Star Voltage L2-N Harmonic #40	Float [32b-LSW]	R	
40947	Star Voltage L2-N Harmonic #41	Float [32b-LSW]	R	
40949	Star Voltage L2-N Harmonic #42	Float [32b-LSW]	R	
40951	Star Voltage L2-N Harmonic #43	Float [32b-LSW]	R	
40953	Star Voltage L2-N Harmonic #44	Float [32b-LSW]	R	
40955	Star Voltage L2-N Harmonic #45	Float [32b-LSW]	R	
40957	Star Voltage L2-N Harmonic #46	Float [32b-LSW]	R	
40959	Star Voltage L2-N Harmonic #47	Float [32b-LSW]	R	
40961	Star Voltage L2-N Harmonic #48	Float [32b-LSW]	R	
40963	Star Voltage L2-N Harmonic #49	Float [32b-LSW]	R	
40965	Star Voltage L2-N Harmonic #50	Float [32b-LSW]	R	
40967	Star Voltage L2-N Harmonic #51	Float [32b-LSW]	R	
40969	Star Voltage L2-N Harmonic #52	Float [32b-LSW]	R	
40971	Star Voltage L2-N Harmonic #53	Float [32b-LSW]	R	
40973	Star Voltage L2-N Harmonic #54	Float [32b-LSW]	R	
40975	Star Voltage L2-N Harmonic #55	Float [32b-LSW]	R	
40977	Star Voltage L2-N Harmonic #56	Float [32b-LSW]	R	
40979	Star Voltage L2-N Harmonic #57	Float [32b-LSW]	R	
40981	Star Voltage L2-N Harmonic #58	Float [32b-LSW]	R	
40983	Star Voltage L2-N Harmonic #59	Float [32b-LSW]	R	



Address Modbus	Description	Register Type	R/W	Default
40985	Star Voltage L2-N Harmonic #60	Float [32b-LSW]	R	
40987	Star Voltage L2-N Harmonic #61	Float [32b-LSW]	R	
40989	Star Voltage L2-N Harmonic #62	Float [32b-LSW]	R	
40991	Star Voltage L2-N Harmonic #63	Float [32b-LSW]	R	
40993	Star Voltage L3-N Harmonic #0	Float [32b-LSW]	R	
40995	Star Voltage L3-N Harmonic #1	Float [32b-LSW]	R	
40997	Star Voltage L3-N Harmonic #2	Float [32b-LSW]	R	
40999	Star Voltage L3-N Harmonic #3	Float [32b-LSW]	R	
41001	Star Voltage L3-N Harmonic #4	Float [32b-LSW]	R	
41003	Star Voltage L3-N Harmonic #5	Float [32b-LSW]	R	
41005	Star Voltage L3-N Harmonic #6	Float [32b-LSW]	R	
41007	Star Voltage L3-N Harmonic #7	Float [32b-LSW]	R	
41009	Star Voltage L3-N Harmonic #8	Float [32b-LSW]	R	
41011	Star Voltage L3-N Harmonic #9	Float [32b-LSW]	R	
41013	Star Voltage L3-N Harmonic #10	Float [32b-LSW]	R	
41015	Star Voltage L3-N Harmonic #11	Float [32b-LSW]	R	
41017	Star Voltage L3-N Harmonic #12	Float [32b-LSW]	R	
41019	Star Voltage L3-N Harmonic #13	Float [32b-LSW]	R	
41021	Star Voltage L3-N Harmonic #14	Float [32b-LSW]	R	
41023	Star Voltage L3-N Harmonic #15	Float [32b-LSW]	R	
41025	Star Voltage L3-N Harmonic #16	Float [32b-LSW]	R	
41027	Star Voltage L3-N Harmonic #17	Float [32b-LSW]	R	
41029	Star Voltage L3-N Harmonic #18	Float [32b-LSW]	R	
41031	Star Voltage L3-N Harmonic #19	Float [32b-LSW]	R	
41033	Star Voltage L3-N Harmonic #20	Float [32b-LSW]	R	
41035	Star Voltage L3-N Harmonic #21	Float [32b-LSW]	R	
41037	Star Voltage L3-N Harmonic #22	Float [32b-LSW]	R	
41039	Star Voltage L3-N Harmonic #23	Float [32b-LSW]	R	
41041	Star Voltage L3-N Harmonic #24	Float [32b-LSW]	R	
41043	Star Voltage L3-N Harmonic #25	Float [32b-LSW]	R	
41045	Star Voltage L3-N Harmonic #26	Float [32b-LSW]	R	
41047	Star Voltage L3-N Harmonic #27	Float [32b-LSW]	R	
41049	Star Voltage L3-N Harmonic #28	Float [32b-LSW]	R	
41051	Star Voltage L3-N Harmonic #29	Float [32b-LSW]	R	
41053	Star Voltage L3-N Harmonic #30	Float [32b-LSW]	R	
41055	Star Voltage L3-N Harmonic #31	Float [32b-LSW]	R	
41057	Star Voltage L3-N Harmonic #32	Float [32b-LSW]	R	
41059	Star Voltage L3-N Harmonic #33	Float [32b-LSW]	R	
41061	Star Voltage L3-N Harmonic #34	Float [32b-LSW]	R	
41063	Star Voltage L3-N Harmonic #35	Float [32b-LSW]	R	
41065	Star Voltage L3-N Harmonic #36	Float [32b-LSW]	R	
41067	Star Voltage L3-N Harmonic #37	Float [32b-LSW]	R	
41069	Star Voltage L3-N Harmonic #38	Float [32b-LSW]	R	
41071	Star Voltage L3-N Harmonic #39	Float [32b-LSW]	R	
41073	Star Voltage L3-N Harmonic #40	Float [32b-LSW]	R	
41075	Star Voltage L3-N Harmonic #41	Float [32b-LSW]	R	
41077	Star Voltage L3-N Harmonic #42	Float [32b-LSW]	R	
41079	Star Voltage L3-N Harmonic #43	Float [32b-LSW]	R	
41081	Star Voltage L3-N Harmonic #44	Float [32b-LSW]	R	
41083	Star Voltage L3-N Harmonic #45	Float [32b-LSW]	R	
41085	Star Voltage L3-N Harmonic #46	Float [32b-LSW]	R	
41087	Star Voltage L3-N Harmonic #47	Float [32b-LSW]	R	
41089	Star Voltage L3-N Harmonic #48	Float [32b-LSW]	R	
41091	Star Voltage L3-N Harmonic #49	Float [32b-LSW]	R	
41093	Star Voltage L3-N Harmonic #50	Float [32b-LSW]	R	
41095	Star Voltage L3-N Harmonic #51	Float [32b-LSW]	R	
41097	Star Voltage L3-N Harmonic #52	Float [32b-LSW]	R	
41099	Star Voltage L3-N Harmonic #53	Float [32b-LSW]	R	
41101	Star Voltage L3-N Harmonic #54	Float [32b-LSW]	R	
41103	Star Voltage L3-N Harmonic #55	Float [32b-LSW]	R	
41105	Star Voltage L3-N Harmonic #56	Float [32b-LSW]	R	
41107	Star Voltage L3-N Harmonic #57	Float [32b-LSW]	R	
41109	Star Voltage L3-N Harmonic #58	Float [32b-LSW]	R	



Address Modbus	Description	Register Type	R/W	Default
4111	Star Voltage L3-N Harmonic #59	Float [32b-LSW]	R	
4113	Star Voltage L3-N Harmonic #60	Float [32b-LSW]	R	
4115	Star Voltage L3-N Harmonic #61	Float [32b-LSW]	R	
4117	Star Voltage L3-N Harmonic #62	Float [32b-LSW]	R	
4119	Star Voltage L3-N Harmonic #63	Float [32b-LSW]	R	
4121	Line Voltage L1-L2 Harmonic #0	Float [32b-LSW]	R	
4123	Line Voltage L1-L2 Harmonic #1	Float [32b-LSW]	R	
4125	Line Voltage L1-L2 Harmonic #2	Float [32b-LSW]	R	
4127	Line Voltage L1-L2 Harmonic #3	Float [32b-LSW]	R	
4129	Line Voltage L1-L2 Harmonic #4	Float [32b-LSW]	R	
4131	Line Voltage L1-L2 Harmonic #5	Float [32b-LSW]	R	
4133	Line Voltage L1-L2 Harmonic #6	Float [32b-LSW]	R	
4135	Line Voltage L1-L2 Harmonic #7	Float [32b-LSW]	R	
4137	Line Voltage L1-L2 Harmonic #8	Float [32b-LSW]	R	
4139	Line Voltage L1-L2 Harmonic #9	Float [32b-LSW]	R	
4141	Line Voltage L1-L2 Harmonic #10	Float [32b-LSW]	R	
4143	Line Voltage L1-L2 Harmonic #11	Float [32b-LSW]	R	
4145	Line Voltage L1-L2 Harmonic #12	Float [32b-LSW]	R	
4147	Line Voltage L1-L2 Harmonic #13	Float [32b-LSW]	R	
4149	Line Voltage L1-L2 Harmonic #14	Float [32b-LSW]	R	
4151	Line Voltage L1-L2 Harmonic #15	Float [32b-LSW]	R	
4153	Line Voltage L1-L2 Harmonic #16	Float [32b-LSW]	R	
4155	Line Voltage L1-L2 Harmonic #17	Float [32b-LSW]	R	
4157	Line Voltage L1-L2 Harmonic #18	Float [32b-LSW]	R	
4159	Line Voltage L1-L2 Harmonic #19	Float [32b-LSW]	R	
4161	Line Voltage L1-L2 Harmonic #20	Float [32b-LSW]	R	
4163	Line Voltage L1-L2 Harmonic #21	Float [32b-LSW]	R	
4165	Line Voltage L1-L2 Harmonic #22	Float [32b-LSW]	R	
4167	Line Voltage L1-L2 Harmonic #23	Float [32b-LSW]	R	
4169	Line Voltage L1-L2 Harmonic #24	Float [32b-LSW]	R	
4171	Line Voltage L1-L2 Harmonic #25	Float [32b-LSW]	R	
4173	Line Voltage L1-L2 Harmonic #26	Float [32b-LSW]	R	
4175	Line Voltage L1-L2 Harmonic #27	Float [32b-LSW]	R	
4177	Line Voltage L1-L2 Harmonic #28	Float [32b-LSW]	R	
4179	Line Voltage L1-L2 Harmonic #29	Float [32b-LSW]	R	
4181	Line Voltage L1-L2 Harmonic #30	Float [32b-LSW]	R	
4183	Line Voltage L1-L2 Harmonic #31	Float [32b-LSW]	R	
4185	Line Voltage L1-L2 Harmonic #32	Float [32b-LSW]	R	
4187	Line Voltage L1-L2 Harmonic #33	Float [32b-LSW]	R	
4189	Line Voltage L1-L2 Harmonic #34	Float [32b-LSW]	R	
4191	Line Voltage L1-L2 Harmonic #35	Float [32b-LSW]	R	
4193	Line Voltage L1-L2 Harmonic #36	Float [32b-LSW]	R	
4195	Line Voltage L1-L2 Harmonic #37	Float [32b-LSW]	R	
4197	Line Voltage L1-L2 Harmonic #38	Float [32b-LSW]	R	
4199	Line Voltage L1-L2 Harmonic #39	Float [32b-LSW]	R	
4201	Line Voltage L1-L2 Harmonic #40	Float [32b-LSW]	R	
4203	Line Voltage L1-L2 Harmonic #41	Float [32b-LSW]	R	
4205	Line Voltage L1-L2 Harmonic #42	Float [32b-LSW]	R	
4207	Line Voltage L1-L2 Harmonic #43	Float [32b-LSW]	R	
4209	Line Voltage L1-L2 Harmonic #44	Float [32b-LSW]	R	
4211	Line Voltage L1-L2 Harmonic #45	Float [32b-LSW]	R	
4213	Line Voltage L1-L2 Harmonic #46	Float [32b-LSW]	R	
4215	Line Voltage L1-L2 Harmonic #47	Float [32b-LSW]	R	
4217	Line Voltage L1-L2 Harmonic #48	Float [32b-LSW]	R	
4219	Line Voltage L1-L2 Harmonic #49	Float [32b-LSW]	R	
4221	Line Voltage L1-L2 Harmonic #50	Float [32b-LSW]	R	
4223	Line Voltage L1-L2 Harmonic #51	Float [32b-LSW]	R	
4225	Line Voltage L1-L2 Harmonic #52	Float [32b-LSW]	R	
4227	Line Voltage L1-L2 Harmonic #53	Float [32b-LSW]	R	
4229	Line Voltage L1-L2 Harmonic #54	Float [32b-LSW]	R	
4231	Line Voltage L1-L2 Harmonic #55	Float [32b-LSW]	R	
4233	Line Voltage L1-L2 Harmonic #56	Float [32b-LSW]	R	
4235	Line Voltage L1-L2 Harmonic #57	Float [32b-LSW]	R	



Address Modbus	Description	Register Type	R/W	Default
41237	Line Voltage L1-L2 Harmonic #58	Float [32b-LSW]	R	
41239	Line Voltage L1-L2 Harmonic #59	Float [32b-LSW]	R	
41241	Line Voltage L1-L2 Harmonic #60	Float [32b-LSW]	R	
41243	Line Voltage L1-L2 Harmonic #61	Float [32b-LSW]	R	
41245	Line Voltage L1-L2 Harmonic #62	Float [32b-LSW]	R	
41247	Line Voltage L1-L2 Harmonic #63	Float [32b-LSW]	R	
41249	Line Voltage L2-L3 Harmonic #0	Float [32b-LSW]	R	
41251	Line Voltage L2-L3 Harmonic #1	Float [32b-LSW]	R	
41253	Line Voltage L2-L3 Harmonic #2	Float [32b-LSW]	R	
41255	Line Voltage L2-L3 Harmonic #3	Float [32b-LSW]	R	
41257	Line Voltage L2-L3 Harmonic #4	Float [32b-LSW]	R	
41259	Line Voltage L2-L3 Harmonic #5	Float [32b-LSW]	R	
41261	Line Voltage L2-L3 Harmonic #6	Float [32b-LSW]	R	
41263	Line Voltage L2-L3 Harmonic #7	Float [32b-LSW]	R	
41265	Line Voltage L2-L3 Harmonic #8	Float [32b-LSW]	R	
41267	Line Voltage L2-L3 Harmonic #9	Float [32b-LSW]	R	
41269	Line Voltage L2-L3 Harmonic #10	Float [32b-LSW]	R	
41271	Line Voltage L2-L3 Harmonic #11	Float [32b-LSW]	R	
41273	Line Voltage L2-L3 Harmonic #12	Float [32b-LSW]	R	
41275	Line Voltage L2-L3 Harmonic #13	Float [32b-LSW]	R	
41277	Line Voltage L2-L3 Harmonic #14	Float [32b-LSW]	R	
41279	Line Voltage L2-L3 Harmonic #15	Float [32b-LSW]	R	
41281	Line Voltage L2-L3 Harmonic #16	Float [32b-LSW]	R	
41283	Line Voltage L2-L3 Harmonic #17	Float [32b-LSW]	R	
41285	Line Voltage L2-L3 Harmonic #18	Float [32b-LSW]	R	
41287	Line Voltage L2-L3 Harmonic #19	Float [32b-LSW]	R	
41289	Line Voltage L2-L3 Harmonic #20	Float [32b-LSW]	R	
41291	Line Voltage L2-L3 Harmonic #21	Float [32b-LSW]	R	
41293	Line Voltage L2-L3 Harmonic #22	Float [32b-LSW]	R	
41295	Line Voltage L2-L3 Harmonic #23	Float [32b-LSW]	R	
41297	Line Voltage L2-L3 Harmonic #24	Float [32b-LSW]	R	
41299	Line Voltage L2-L3 Harmonic #25	Float [32b-LSW]	R	
41301	Line Voltage L2-L3 Harmonic #26	Float [32b-LSW]	R	
41303	Line Voltage L2-L3 Harmonic #27	Float [32b-LSW]	R	
41305	Line Voltage L2-L3 Harmonic #28	Float [32b-LSW]	R	
41307	Line Voltage L2-L3 Harmonic #29	Float [32b-LSW]	R	
41309	Line Voltage L2-L3 Harmonic #30	Float [32b-LSW]	R	
41311	Line Voltage L2-L3 Harmonic #31	Float [32b-LSW]	R	
41313	Line Voltage L2-L3 Harmonic #32	Float [32b-LSW]	R	
41315	Line Voltage L2-L3 Harmonic #33	Float [32b-LSW]	R	
41317	Line Voltage L2-L3 Harmonic #34	Float [32b-LSW]	R	
41319	Line Voltage L2-L3 Harmonic #35	Float [32b-LSW]	R	
41321	Line Voltage L2-L3 Harmonic #36	Float [32b-LSW]	R	
41323	Line Voltage L2-L3 Harmonic #37	Float [32b-LSW]	R	
41325	Line Voltage L2-L3 Harmonic #38	Float [32b-LSW]	R	
41327	Line Voltage L2-L3 Harmonic #39	Float [32b-LSW]	R	
41329	Line Voltage L2-L3 Harmonic #40	Float [32b-LSW]	R	
41331	Line Voltage L2-L3 Harmonic #41	Float [32b-LSW]	R	
41333	Line Voltage L2-L3 Harmonic #42	Float [32b-LSW]	R	
41335	Line Voltage L2-L3 Harmonic #43	Float [32b-LSW]	R	
41337	Line Voltage L2-L3 Harmonic #44	Float [32b-LSW]	R	
41339	Line Voltage L2-L3 Harmonic #45	Float [32b-LSW]	R	
41341	Line Voltage L2-L3 Harmonic #46	Float [32b-LSW]	R	
41343	Line Voltage L2-L3 Harmonic #47	Float [32b-LSW]	R	
41345	Line Voltage L2-L3 Harmonic #48	Float [32b-LSW]	R	
41347	Line Voltage L2-L3 Harmonic #49	Float [32b-LSW]	R	
41349	Line Voltage L2-L3 Harmonic #50	Float [32b-LSW]	R	
41351	Line Voltage L2-L3 Harmonic #51	Float [32b-LSW]	R	
41353	Line Voltage L2-L3 Harmonic #52	Float [32b-LSW]	R	
41355	Line Voltage L2-L3 Harmonic #53	Float [32b-LSW]	R	
41357	Line Voltage L2-L3 Harmonic #54	Float [32b-LSW]	R	
41359	Line Voltage L2-L3 Harmonic #55	Float [32b-LSW]	R	
41361	Line Voltage L2-L3 Harmonic #56	Float [32b-LSW]	R	



Address Modbus	Description	Register Type	R/W	Default
41363	Line Voltage L2-L3 Harmonic #57	Float [32b-LSW]	R	
41365	Line Voltage L2-L3 Harmonic #58	Float [32b-LSW]	R	
41367	Line Voltage L2-L3 Harmonic #59	Float [32b-LSW]	R	
41369	Line Voltage L2-L3 Harmonic #60	Float [32b-LSW]	R	
41371	Line Voltage L2-L3 Harmonic #61	Float [32b-LSW]	R	
41373	Line Voltage L2-L3 Harmonic #62	Float [32b-LSW]	R	
41375	Line Voltage L2-L3 Harmonic #63	Float [32b-LSW]	R	
41377	Line Voltage L3-L1 Harmonic #0	Float [32b-LSW]	R	
41379	Line Voltage L3-L1 Harmonic #1	Float [32b-LSW]	R	
41381	Line Voltage L3-L1 Harmonic #2	Float [32b-LSW]	R	
41383	Line Voltage L3-L1 Harmonic #3	Float [32b-LSW]	R	
41385	Line Voltage L3-L1 Harmonic #4	Float [32b-LSW]	R	
41387	Line Voltage L3-L1 Harmonic #5	Float [32b-LSW]	R	
41389	Line Voltage L3-L1 Harmonic #6	Float [32b-LSW]	R	
41391	Line Voltage L3-L1 Harmonic #7	Float [32b-LSW]	R	
41393	Line Voltage L3-L1 Harmonic #8	Float [32b-LSW]	R	
41395	Line Voltage L3-L1 Harmonic #9	Float [32b-LSW]	R	
41397	Line Voltage L3-L1 Harmonic #10	Float [32b-LSW]	R	
41399	Line Voltage L3-L1 Harmonic #11	Float [32b-LSW]	R	
41401	Line Voltage L3-L1 Harmonic #12	Float [32b-LSW]	R	
41403	Line Voltage L3-L1 Harmonic #13	Float [32b-LSW]	R	
41405	Line Voltage L3-L1 Harmonic #14	Float [32b-LSW]	R	
41407	Line Voltage L3-L1 Harmonic #15	Float [32b-LSW]	R	
41409	Line Voltage L3-L1 Harmonic #16	Float [32b-LSW]	R	
41411	Line Voltage L3-L1 Harmonic #17	Float [32b-LSW]	R	
41413	Line Voltage L3-L1 Harmonic #18	Float [32b-LSW]	R	
41415	Line Voltage L3-L1 Harmonic #19	Float [32b-LSW]	R	
41417	Line Voltage L3-L1 Harmonic #20	Float [32b-LSW]	R	
41419	Line Voltage L3-L1 Harmonic #21	Float [32b-LSW]	R	
41421	Line Voltage L3-L1 Harmonic #22	Float [32b-LSW]	R	
41423	Line Voltage L3-L1 Harmonic #23	Float [32b-LSW]	R	
41425	Line Voltage L3-L1 Harmonic #24	Float [32b-LSW]	R	
41427	Line Voltage L3-L1 Harmonic #25	Float [32b-LSW]	R	
41429	Line Voltage L3-L1 Harmonic #26	Float [32b-LSW]	R	
41431	Line Voltage L3-L1 Harmonic #27	Float [32b-LSW]	R	
41433	Line Voltage L3-L1 Harmonic #28	Float [32b-LSW]	R	
41435	Line Voltage L3-L1 Harmonic #29	Float [32b-LSW]	R	
41437	Line Voltage L3-L1 Harmonic #30	Float [32b-LSW]	R	
41439	Line Voltage L3-L1 Harmonic #31	Float [32b-LSW]	R	
41441	Line Voltage L3-L1 Harmonic #32	Float [32b-LSW]	R	
41443	Line Voltage L3-L1 Harmonic #33	Float [32b-LSW]	R	
41445	Line Voltage L3-L1 Harmonic #34	Float [32b-LSW]	R	
41447	Line Voltage L3-L1 Harmonic #35	Float [32b-LSW]	R	
41449	Line Voltage L3-L1 Harmonic #36	Float [32b-LSW]	R	
41451	Line Voltage L3-L1 Harmonic #37	Float [32b-LSW]	R	
41453	Line Voltage L3-L1 Harmonic #38	Float [32b-LSW]	R	
41455	Line Voltage L3-L1 Harmonic #39	Float [32b-LSW]	R	
41457	Line Voltage L3-L1 Harmonic #40	Float [32b-LSW]	R	
41459	Line Voltage L3-L1 Harmonic #41	Float [32b-LSW]	R	
41461	Line Voltage L3-L1 Harmonic #42	Float [32b-LSW]	R	
41463	Line Voltage L3-L1 Harmonic #43	Float [32b-LSW]	R	
41465	Line Voltage L3-L1 Harmonic #44	Float [32b-LSW]	R	
41467	Line Voltage L3-L1 Harmonic #45	Float [32b-LSW]	R	
41469	Line Voltage L3-L1 Harmonic #46	Float [32b-LSW]	R	
41471	Line Voltage L3-L1 Harmonic #47	Float [32b-LSW]	R	
41473	Line Voltage L3-L1 Harmonic #48	Float [32b-LSW]	R	
41475	Line Voltage L3-L1 Harmonic #49	Float [32b-LSW]	R	
41477	Line Voltage L3-L1 Harmonic #50	Float [32b-LSW]	R	
41479	Line Voltage L3-L1 Harmonic #51	Float [32b-LSW]	R	
41481	Line Voltage L3-L1 Harmonic #52	Float [32b-LSW]	R	
41483	Line Voltage L3-L1 Harmonic #53	Float [32b-LSW]	R	
41485	Line Voltage L3-L1 Harmonic #54	Float [32b-LSW]	R	
41487	Line Voltage L3-L1 Harmonic #55	Float [32b-LSW]	R	



Address Modbus	Description	Register Type	R/W	Default
41489	Line Voltage L3-L1 Harmonic #56	Float [32b-LSW]	R	
41491	Line Voltage L3-L1 Harmonic #57	Float [32b-LSW]	R	
41493	Line Voltage L3-L1 Harmonic #58	Float [32b-LSW]	R	
41495	Line Voltage L3-L1 Harmonic #59	Float [32b-LSW]	R	
41497	Line Voltage L3-L1 Harmonic #60	Float [32b-LSW]	R	
41499	Line Voltage L3-L1 Harmonic #61	Float [32b-LSW]	R	
41501	Line Voltage L3-L1 Harmonic #62	Float [32b-LSW]	R	
41503	Line Voltage L3-L1 Harmonic #63	Float [32b-LSW]	R	
41505	Line Current L1 Harmonic #0	Float [32b-LSW]	R	
41507	Line Current L1 Harmonic #1	Float [32b-LSW]	R	
41509	Line Current L1 Harmonic #2	Float [32b-LSW]	R	
41511	Line Current L1 Harmonic #3	Float [32b-LSW]	R	
41513	Line Current L1 Harmonic #4	Float [32b-LSW]	R	
41515	Line Current L1 Harmonic #5	Float [32b-LSW]	R	
41517	Line Current L1 Harmonic #6	Float [32b-LSW]	R	
41519	Line Current L1 Harmonic #7	Float [32b-LSW]	R	
41521	Line Current L1 Harmonic #8	Float [32b-LSW]	R	
41523	Line Current L1 Harmonic #9	Float [32b-LSW]	R	
41525	Line Current L1 Harmonic #10	Float [32b-LSW]	R	
41527	Line Current L1 Harmonic #11	Float [32b-LSW]	R	
41529	Line Current L1 Harmonic #12	Float [32b-LSW]	R	
41531	Line Current L1 Harmonic #13	Float [32b-LSW]	R	
41533	Line Current L1 Harmonic #14	Float [32b-LSW]	R	
41535	Line Current L1 Harmonic #15	Float [32b-LSW]	R	
41537	Line Current L1 Harmonic #16	Float [32b-LSW]	R	
41539	Line Current L1 Harmonic #17	Float [32b-LSW]	R	
41541	Line Current L1 Harmonic #18	Float [32b-LSW]	R	
41543	Line Current L1 Harmonic #19	Float [32b-LSW]	R	
41545	Line Current L1 Harmonic #20	Float [32b-LSW]	R	
41547	Line Current L1 Harmonic #21	Float [32b-LSW]	R	
41549	Line Current L1 Harmonic #22	Float [32b-LSW]	R	
41551	Line Current L1 Harmonic #23	Float [32b-LSW]	R	
41553	Line Current L1 Harmonic #24	Float [32b-LSW]	R	
41555	Line Current L1 Harmonic #25	Float [32b-LSW]	R	
41557	Line Current L1 Harmonic #26	Float [32b-LSW]	R	
41559	Line Current L1 Harmonic #27	Float [32b-LSW]	R	
41561	Line Current L1 Harmonic #28	Float [32b-LSW]	R	
41563	Line Current L1 Harmonic #29	Float [32b-LSW]	R	
41565	Line Current L1 Harmonic #30	Float [32b-LSW]	R	
41567	Line Current L1 Harmonic #31	Float [32b-LSW]	R	
41569	Line Current L1 Harmonic #32	Float [32b-LSW]	R	
41571	Line Current L1 Harmonic #33	Float [32b-LSW]	R	
41573	Line Current L1 Harmonic #34	Float [32b-LSW]	R	
41575	Line Current L1 Harmonic #35	Float [32b-LSW]	R	
41577	Line Current L1 Harmonic #36	Float [32b-LSW]	R	
41579	Line Current L1 Harmonic #37	Float [32b-LSW]	R	
41581	Line Current L1 Harmonic #38	Float [32b-LSW]	R	
41583	Line Current L1 Harmonic #39	Float [32b-LSW]	R	
41585	Line Current L1 Harmonic #40	Float [32b-LSW]	R	
41587	Line Current L1 Harmonic #41	Float [32b-LSW]	R	
41589	Line Current L1 Harmonic #42	Float [32b-LSW]	R	
41591	Line Current L1 Harmonic #43	Float [32b-LSW]	R	
41593	Line Current L1 Harmonic #44	Float [32b-LSW]	R	
41595	Line Current L1 Harmonic #45	Float [32b-LSW]	R	
41597	Line Current L1 Harmonic #46	Float [32b-LSW]	R	
41599	Line Current L1 Harmonic #47	Float [32b-LSW]	R	
41601	Line Current L1 Harmonic #48	Float [32b-LSW]	R	
41603	Line Current L1 Harmonic #49	Float [32b-LSW]	R	
41605	Line Current L1 Harmonic #50	Float [32b-LSW]	R	
41607	Line Current L1 Harmonic #51	Float [32b-LSW]	R	
41609	Line Current L1 Harmonic #52	Float [32b-LSW]	R	
41611	Line Current L1 Harmonic #53	Float [32b-LSW]	R	
41613	Line Current L1 Harmonic #54	Float [32b-LSW]	R	



Address Modbus	Description	Register Type	R/W	Default
41615	Line Current L1 Harmonic #55	Float [32b-LSW]	R	
41617	Line Current L1 Harmonic #56	Float [32b-LSW]	R	
41619	Line Current L1 Harmonic #57	Float [32b-LSW]	R	
41621	Line Current L1 Harmonic #58	Float [32b-LSW]	R	
41623	Line Current L1 Harmonic #59	Float [32b-LSW]	R	
41625	Line Current L1 Harmonic #60	Float [32b-LSW]	R	
41627	Line Current L1 Harmonic #61	Float [32b-LSW]	R	
41629	Line Current L1 Harmonic #62	Float [32b-LSW]	R	
41631	Line Current L1 Harmonic #63	Float [32b-LSW]	R	
41633	Line Current L2 Harmonic #0	Float [32b-LSW]	R	
41635	Line Current L2 Harmonic #1	Float [32b-LSW]	R	
41637	Line Current L2 Harmonic #2	Float [32b-LSW]	R	
41639	Line Current L2 Harmonic #3	Float [32b-LSW]	R	
41641	Line Current L2 Harmonic #4	Float [32b-LSW]	R	
41643	Line Current L2 Harmonic #5	Float [32b-LSW]	R	
41645	Line Current L2 Harmonic #6	Float [32b-LSW]	R	
41647	Line Current L2 Harmonic #7	Float [32b-LSW]	R	
41649	Line Current L2 Harmonic #8	Float [32b-LSW]	R	
41651	Line Current L2 Harmonic #9	Float [32b-LSW]	R	
41653	Line Current L2 Harmonic #10	Float [32b-LSW]	R	
41655	Line Current L2 Harmonic #11	Float [32b-LSW]	R	
41657	Line Current L2 Harmonic #12	Float [32b-LSW]	R	
41659	Line Current L2 Harmonic #13	Float [32b-LSW]	R	
41661	Line Current L2 Harmonic #14	Float [32b-LSW]	R	
41663	Line Current L2 Harmonic #15	Float [32b-LSW]	R	
41665	Line Current L2 Harmonic #16	Float [32b-LSW]	R	
41667	Line Current L2 Harmonic #17	Float [32b-LSW]	R	
41669	Line Current L2 Harmonic #18	Float [32b-LSW]	R	
41671	Line Current L2 Harmonic #19	Float [32b-LSW]	R	
41673	Line Current L2 Harmonic #20	Float [32b-LSW]	R	
41675	Line Current L2 Harmonic #21	Float [32b-LSW]	R	
41677	Line Current L2 Harmonic #22	Float [32b-LSW]	R	
41679	Line Current L2 Harmonic #23	Float [32b-LSW]	R	
41681	Line Current L2 Harmonic #24	Float [32b-LSW]	R	
41683	Line Current L2 Harmonic #25	Float [32b-LSW]	R	
41685	Line Current L2 Harmonic #26	Float [32b-LSW]	R	
41687	Line Current L2 Harmonic #27	Float [32b-LSW]	R	
41689	Line Current L2 Harmonic #28	Float [32b-LSW]	R	
41691	Line Current L2 Harmonic #29	Float [32b-LSW]	R	
41693	Line Current L2 Harmonic #30	Float [32b-LSW]	R	
41695	Line Current L2 Harmonic #31	Float [32b-LSW]	R	
41697	Line Current L2 Harmonic #32	Float [32b-LSW]	R	
41699	Line Current L2 Harmonic #33	Float [32b-LSW]	R	
41701	Line Current L2 Harmonic #34	Float [32b-LSW]	R	
41703	Line Current L2 Harmonic #35	Float [32b-LSW]	R	
41705	Line Current L2 Harmonic #36	Float [32b-LSW]	R	
41707	Line Current L2 Harmonic #37	Float [32b-LSW]	R	
41709	Line Current L2 Harmonic #38	Float [32b-LSW]	R	
41711	Line Current L2 Harmonic #39	Float [32b-LSW]	R	
41713	Line Current L2 Harmonic #40	Float [32b-LSW]	R	
41715	Line Current L2 Harmonic #41	Float [32b-LSW]	R	
41717	Line Current L2 Harmonic #42	Float [32b-LSW]	R	
41719	Line Current L2 Harmonic #43	Float [32b-LSW]	R	
41721	Line Current L2 Harmonic #44	Float [32b-LSW]	R	
41723	Line Current L2 Harmonic #45	Float [32b-LSW]	R	
41725	Line Current L2 Harmonic #46	Float [32b-LSW]	R	
41727	Line Current L2 Harmonic #47	Float [32b-LSW]	R	
41729	Line Current L2 Harmonic #48	Float [32b-LSW]	R	
41731	Line Current L2 Harmonic #49	Float [32b-LSW]	R	
41733	Line Current L2 Harmonic #50	Float [32b-LSW]	R	
41735	Line Current L2 Harmonic #51	Float [32b-LSW]	R	
41737	Line Current L2 Harmonic #52	Float [32b-LSW]	R	
41739	Line Current L2 Harmonic #53	Float [32b-LSW]	R	



Address Modbus	Description	Register Type	R/W	Default
41741	Line Current L2 Harmonic #54	Float [32b-LSW]	R	
41743	Line Current L2 Harmonic #55	Float [32b-LSW]	R	
41745	Line Current L2 Harmonic #56	Float [32b-LSW]	R	
41747	Line Current L2 Harmonic #57	Float [32b-LSW]	R	
41749	Line Current L2 Harmonic #58	Float [32b-LSW]	R	
41751	Line Current L2 Harmonic #59	Float [32b-LSW]	R	
41753	Line Current L2 Harmonic #60	Float [32b-LSW]	R	
41755	Line Current L2 Harmonic #61	Float [32b-LSW]	R	
41757	Line Current L2 Harmonic #62	Float [32b-LSW]	R	
41759	Line Current L2 Harmonic #63	Float [32b-LSW]	R	
41761	Line Current L3 Harmonic #0	Float [32b-LSW]	R	
41763	Line Current L3 Harmonic #1	Float [32b-LSW]	R	
41765	Line Current L3 Harmonic #2	Float [32b-LSW]	R	
41767	Line Current L3 Harmonic #3	Float [32b-LSW]	R	
41769	Line Current L3 Harmonic #4	Float [32b-LSW]	R	
41771	Line Current L3 Harmonic #5	Float [32b-LSW]	R	
41773	Line Current L3 Harmonic #6	Float [32b-LSW]	R	
41775	Line Current L3 Harmonic #7	Float [32b-LSW]	R	
41777	Line Current L3 Harmonic #8	Float [32b-LSW]	R	
41779	Line Current L3 Harmonic #9	Float [32b-LSW]	R	
41781	Line Current L3 Harmonic #10	Float [32b-LSW]	R	
41783	Line Current L3 Harmonic #11	Float [32b-LSW]	R	
41785	Line Current L3 Harmonic #12	Float [32b-LSW]	R	
41787	Line Current L3 Harmonic #13	Float [32b-LSW]	R	
41789	Line Current L3 Harmonic #14	Float [32b-LSW]	R	
41791	Line Current L3 Harmonic #15	Float [32b-LSW]	R	
41793	Line Current L3 Harmonic #16	Float [32b-LSW]	R	
41795	Line Current L3 Harmonic #17	Float [32b-LSW]	R	
41797	Line Current L3 Harmonic #18	Float [32b-LSW]	R	
41799	Line Current L3 Harmonic #19	Float [32b-LSW]	R	
41801	Line Current L3 Harmonic #20	Float [32b-LSW]	R	
41803	Line Current L3 Harmonic #21	Float [32b-LSW]	R	
41805	Line Current L3 Harmonic #22	Float [32b-LSW]	R	
41807	Line Current L3 Harmonic #23	Float [32b-LSW]	R	
41809	Line Current L3 Harmonic #24	Float [32b-LSW]	R	
41811	Line Current L3 Harmonic #25	Float [32b-LSW]	R	
41813	Line Current L3 Harmonic #26	Float [32b-LSW]	R	
41815	Line Current L3 Harmonic #27	Float [32b-LSW]	R	
41817	Line Current L3 Harmonic #28	Float [32b-LSW]	R	
41819	Line Current L3 Harmonic #29	Float [32b-LSW]	R	
41821	Line Current L3 Harmonic #30	Float [32b-LSW]	R	
41823	Line Current L3 Harmonic #31	Float [32b-LSW]	R	
41825	Line Current L3 Harmonic #32	Float [32b-LSW]	R	
41827	Line Current L3 Harmonic #33	Float [32b-LSW]	R	
41829	Line Current L3 Harmonic #34	Float [32b-LSW]	R	
41831	Line Current L3 Harmonic #35	Float [32b-LSW]	R	
41833	Line Current L3 Harmonic #36	Float [32b-LSW]	R	
41835	Line Current L3 Harmonic #37	Float [32b-LSW]	R	
41837	Line Current L3 Harmonic #38	Float [32b-LSW]	R	
41839	Line Current L3 Harmonic #39	Float [32b-LSW]	R	
41841	Line Current L3 Harmonic #40	Float [32b-LSW]	R	
41843	Line Current L3 Harmonic #41	Float [32b-LSW]	R	
41845	Line Current L3 Harmonic #42	Float [32b-LSW]	R	
41847	Line Current L3 Harmonic #43	Float [32b-LSW]	R	
41849	Line Current L3 Harmonic #44	Float [32b-LSW]	R	
41851	Line Current L3 Harmonic #45	Float [32b-LSW]	R	
41853	Line Current L3 Harmonic #46	Float [32b-LSW]	R	
41855	Line Current L3 Harmonic #47	Float [32b-LSW]	R	
41857	Line Current L3 Harmonic #48	Float [32b-LSW]	R	
41859	Line Current L3 Harmonic #49	Float [32b-LSW]	R	
41861	Line Current L3 Harmonic #50	Float [32b-LSW]	R	
41863	Line Current L3 Harmonic #51	Float [32b-LSW]	R	
41865	Line Current L3 Harmonic #52	Float [32b-LSW]	R	



Address Modbus	Description	Register Type	R/W	Default
41867	Line Current L3 Harmonic #53	Float [32b-LSW]	R	
41869	Line Current L3 Harmonic #54	Float [32b-LSW]	R	
41871	Line Current L3 Harmonic #55	Float [32b-LSW]	R	
41873	Line Current L3 Harmonic #56	Float [32b-LSW]	R	
41875	Line Current L3 Harmonic #57	Float [32b-LSW]	R	
41877	Line Current L3 Harmonic #58	Float [32b-LSW]	R	
41879	Line Current L3 Harmonic #59	Float [32b-LSW]	R	
41881	Line Current L3 Harmonic #60	Float [32b-LSW]	R	
41883	Line Current L3 Harmonic #61	Float [32b-LSW]	R	
41885	Line Current L3 Harmonic #62	Float [32b-LSW]	R	
41887	Line Current L3 Harmonic #63	Float [32b-LSW]	R	
41889	Line Current N Harmonic #0	Float [32b-LSW]	R	
41891	Line Current N Harmonic #1	Float [32b-LSW]	R	
41893	Line Current N Harmonic #2	Float [32b-LSW]	R	
41895	Line Current N Harmonic #3	Float [32b-LSW]	R	
41897	Line Current N Harmonic #4	Float [32b-LSW]	R	
41899	Line Current N Harmonic #5	Float [32b-LSW]	R	
41901	Line Current N Harmonic #6	Float [32b-LSW]	R	
41903	Line Current N Harmonic #7	Float [32b-LSW]	R	
41905	Line Current N Harmonic #8	Float [32b-LSW]	R	
41907	Line Current N Harmonic #9	Float [32b-LSW]	R	
41909	Line Current N Harmonic #10	Float [32b-LSW]	R	
41911	Line Current N Harmonic #11	Float [32b-LSW]	R	
41913	Line Current N Harmonic #12	Float [32b-LSW]	R	
41915	Line Current N Harmonic #13	Float [32b-LSW]	R	
41917	Line Current N Harmonic #14	Float [32b-LSW]	R	
41919	Line Current N Harmonic #15	Float [32b-LSW]	R	
41921	Line Current N Harmonic #16	Float [32b-LSW]	R	
41923	Line Current N Harmonic #17	Float [32b-LSW]	R	
41925	Line Current N Harmonic #18	Float [32b-LSW]	R	
41927	Line Current N Harmonic #19	Float [32b-LSW]	R	
41929	Line Current N Harmonic #20	Float [32b-LSW]	R	
41931	Line Current N Harmonic #21	Float [32b-LSW]	R	
41933	Line Current N Harmonic #22	Float [32b-LSW]	R	
41935	Line Current N Harmonic #23	Float [32b-LSW]	R	
41937	Line Current N Harmonic #24	Float [32b-LSW]	R	
41939	Line Current N Harmonic #25	Float [32b-LSW]	R	
41941	Line Current N Harmonic #26	Float [32b-LSW]	R	
41943	Line Current N Harmonic #27	Float [32b-LSW]	R	
41945	Line Current N Harmonic #28	Float [32b-LSW]	R	
41947	Line Current N Harmonic #29	Float [32b-LSW]	R	
41949	Line Current N Harmonic #30	Float [32b-LSW]	R	
41951	Line Current N Harmonic #31	Float [32b-LSW]	R	
41953	Line Current N Harmonic #32	Float [32b-LSW]	R	
41955	Line Current N Harmonic #33	Float [32b-LSW]	R	
41957	Line Current N Harmonic #34	Float [32b-LSW]	R	
41959	Line Current N Harmonic #35	Float [32b-LSW]	R	
41961	Line Current N Harmonic #36	Float [32b-LSW]	R	
41963	Line Current N Harmonic #37	Float [32b-LSW]	R	
41965	Line Current N Harmonic #38	Float [32b-LSW]	R	
41967	Line Current N Harmonic #39	Float [32b-LSW]	R	
41969	Line Current N Harmonic #40	Float [32b-LSW]	R	
41971	Line Current N Harmonic #41	Float [32b-LSW]	R	
41973	Line Current N Harmonic #42	Float [32b-LSW]	R	
41975	Line Current N Harmonic #43	Float [32b-LSW]	R	
41977	Line Current N Harmonic #44	Float [32b-LSW]	R	
41979	Line Current N Harmonic #45	Float [32b-LSW]	R	
41981	Line Current N Harmonic #46	Float [32b-LSW]	R	
41983	Line Current N Harmonic #47	Float [32b-LSW]	R	
41985	Line Current N Harmonic #48	Float [32b-LSW]	R	
41987	Line Current N Harmonic #49	Float [32b-LSW]	R	
41989	Line Current N Harmonic #50	Float [32b-LSW]	R	
41991	Line Current N Harmonic #51	Float [32b-LSW]	R	



Address Modbus	Description	Register Type	R/W	Default
41993	Line Current N Harmonic #52	Float [32b-LSW]	R	
41995	Line Current N Harmonic #53	Float [32b-LSW]	R	
41997	Line Current N Harmonic #54	Float [32b-LSW]	R	
41999	Line Current N Harmonic #55	Float [32b-LSW]	R	
42001	Line Current N Harmonic #56	Float [32b-LSW]	R	
42003	Line Current N Harmonic #57	Float [32b-LSW]	R	
42005	Line Current N Harmonic #58	Float [32b-LSW]	R	
42007	Line Current N Harmonic #59	Float [32b-LSW]	R	
42009	Line Current N Harmonic #60	Float [32b-LSW]	R	
42011	Line Current N Harmonic #61	Float [32b-LSW]	R	
42013	Line Current N Harmonic #62	Float [32b-LSW]	R	
42015	Line Current N Harmonic #63	Float [32b-LSW]	R	
42017	Star Voltage L1-N InterHarmonic #0	Float [32b-LSW]	R	
42019	Star Voltage L1-N InterHarmonic #1	Float [32b-LSW]	R	
42021	Star Voltage L1-N InterHarmonic #2	Float [32b-LSW]	R	
42023	Star Voltage L1-N InterHarmonic #3	Float [32b-LSW]	R	
42025	Star Voltage L1-N InterHarmonic #4	Float [32b-LSW]	R	
42027	Star Voltage L1-N InterHarmonic #5	Float [32b-LSW]	R	
42029	Star Voltage L1-N InterHarmonic #6	Float [32b-LSW]	R	
42031	Star Voltage L1-N InterHarmonic #7	Float [32b-LSW]	R	
42033	Star Voltage L1-N InterHarmonic #8	Float [32b-LSW]	R	
42035	Star Voltage L1-N InterHarmonic #9	Float [32b-LSW]	R	
42037	Star Voltage L1-N InterHarmonic #10	Float [32b-LSW]	R	
42039	Star Voltage L1-N InterHarmonic #11	Float [32b-LSW]	R	
42041	Star Voltage L1-N InterHarmonic #12	Float [32b-LSW]	R	
42043	Star Voltage L1-N InterHarmonic #13	Float [32b-LSW]	R	
42045	Star Voltage L1-N InterHarmonic #14	Float [32b-LSW]	R	
42047	Star Voltage L1-N InterHarmonic #15	Float [32b-LSW]	R	
42049	Star Voltage L1-N InterHarmonic #16	Float [32b-LSW]	R	
42051	Star Voltage L1-N InterHarmonic #17	Float [32b-LSW]	R	
42053	Star Voltage L1-N InterHarmonic #18	Float [32b-LSW]	R	
42055	Star Voltage L1-N InterHarmonic #19	Float [32b-LSW]	R	
42057	Star Voltage L1-N InterHarmonic #20	Float [32b-LSW]	R	
42059	Star Voltage L1-N InterHarmonic #21	Float [32b-LSW]	R	
42061	Star Voltage L1-N InterHarmonic #22	Float [32b-LSW]	R	
42063	Star Voltage L1-N InterHarmonic #23	Float [32b-LSW]	R	
42065	Star Voltage L1-N InterHarmonic #24	Float [32b-LSW]	R	
42067	Star Voltage L1-N InterHarmonic #25	Float [32b-LSW]	R	
42069	Star Voltage L1-N InterHarmonic #26	Float [32b-LSW]	R	
42071	Star Voltage L1-N InterHarmonic #27	Float [32b-LSW]	R	
42073	Star Voltage L1-N InterHarmonic #28	Float [32b-LSW]	R	
42075	Star Voltage L1-N InterHarmonic #29	Float [32b-LSW]	R	
42077	Star Voltage L1-N InterHarmonic #30	Float [32b-LSW]	R	
42079	Star Voltage L1-N InterHarmonic #31	Float [32b-LSW]	R	
42081	Star Voltage L1-N InterHarmonic #32	Float [32b-LSW]	R	
42083	Star Voltage L1-N InterHarmonic #33	Float [32b-LSW]	R	
42085	Star Voltage L1-N InterHarmonic #34	Float [32b-LSW]	R	
42087	Star Voltage L1-N InterHarmonic #35	Float [32b-LSW]	R	
42089	Star Voltage L1-N InterHarmonic #36	Float [32b-LSW]	R	
42091	Star Voltage L1-N InterHarmonic #37	Float [32b-LSW]	R	
42093	Star Voltage L1-N InterHarmonic #38	Float [32b-LSW]	R	
42095	Star Voltage L1-N InterHarmonic #39	Float [32b-LSW]	R	
42097	Star Voltage L1-N InterHarmonic #40	Float [32b-LSW]	R	
42099	Star Voltage L1-N InterHarmonic #41	Float [32b-LSW]	R	
42101	Star Voltage L1-N InterHarmonic #42	Float [32b-LSW]	R	
42103	Star Voltage L1-N InterHarmonic #43	Float [32b-LSW]	R	
42105	Star Voltage L1-N InterHarmonic #44	Float [32b-LSW]	R	
42107	Star Voltage L1-N InterHarmonic #45	Float [32b-LSW]	R	
42109	Star Voltage L1-N InterHarmonic #46	Float [32b-LSW]	R	
42111	Star Voltage L1-N InterHarmonic #47	Float [32b-LSW]	R	
42113	Star Voltage L1-N InterHarmonic #48	Float [32b-LSW]	R	
42115	Star Voltage L1-N InterHarmonic #49	Float [32b-LSW]	R	
42117	Star Voltage L1-N InterHarmonic #50	Float [32b-LSW]	R	



Address Modbus	Description	Register Type	R/W	Default
42119	Star Voltage L1-N InterHarmonic #51	Float [32b-LSW]	R	
42121	Star Voltage L1-N InterHarmonic #52	Float [32b-LSW]	R	
42123	Star Voltage L1-N InterHarmonic #53	Float [32b-LSW]	R	
42125	Star Voltage L1-N InterHarmonic #54	Float [32b-LSW]	R	
42127	Star Voltage L1-N InterHarmonic #55	Float [32b-LSW]	R	
42129	Star Voltage L1-N InterHarmonic #56	Float [32b-LSW]	R	
42131	Star Voltage L1-N InterHarmonic #57	Float [32b-LSW]	R	
42133	Star Voltage L1-N InterHarmonic #58	Float [32b-LSW]	R	
42135	Star Voltage L1-N InterHarmonic #59	Float [32b-LSW]	R	
42137	Star Voltage L1-N InterHarmonic #60	Float [32b-LSW]	R	
42139	Star Voltage L1-N InterHarmonic #61	Float [32b-LSW]	R	
42141	Star Voltage L1-N InterHarmonic #62	Float [32b-LSW]	R	
42143	Star Voltage L1-N InterHarmonic #63	Float [32b-LSW]	R	
42145	Star Voltage L2-N InterHarmonic #0	Float [32b-LSW]	R	
42147	Star Voltage L2-N InterHarmonic #1	Float [32b-LSW]	R	
42149	Star Voltage L2-N InterHarmonic #2	Float [32b-LSW]	R	
42151	Star Voltage L2-N InterHarmonic #3	Float [32b-LSW]	R	
42153	Star Voltage L2-N InterHarmonic #4	Float [32b-LSW]	R	
42155	Star Voltage L2-N InterHarmonic #5	Float [32b-LSW]	R	
42157	Star Voltage L2-N InterHarmonic #6	Float [32b-LSW]	R	
42159	Star Voltage L2-N InterHarmonic #7	Float [32b-LSW]	R	
42161	Star Voltage L2-N InterHarmonic #8	Float [32b-LSW]	R	
42163	Star Voltage L2-N InterHarmonic #9	Float [32b-LSW]	R	
42165	Star Voltage L2-N InterHarmonic #10	Float [32b-LSW]	R	
42167	Star Voltage L2-N InterHarmonic #11	Float [32b-LSW]	R	
42169	Star Voltage L2-N InterHarmonic #12	Float [32b-LSW]	R	
42171	Star Voltage L2-N InterHarmonic #13	Float [32b-LSW]	R	
42173	Star Voltage L2-N InterHarmonic #14	Float [32b-LSW]	R	
42175	Star Voltage L2-N InterHarmonic #15	Float [32b-LSW]	R	
42177	Star Voltage L2-N InterHarmonic #16	Float [32b-LSW]	R	
42179	Star Voltage L2-N InterHarmonic #17	Float [32b-LSW]	R	
42181	Star Voltage L2-N InterHarmonic #18	Float [32b-LSW]	R	
42183	Star Voltage L2-N InterHarmonic #19	Float [32b-LSW]	R	
42185	Star Voltage L2-N InterHarmonic #20	Float [32b-LSW]	R	
42187	Star Voltage L2-N InterHarmonic #21	Float [32b-LSW]	R	
42189	Star Voltage L2-N InterHarmonic #22	Float [32b-LSW]	R	
42191	Star Voltage L2-N InterHarmonic #23	Float [32b-LSW]	R	
42193	Star Voltage L2-N InterHarmonic #24	Float [32b-LSW]	R	
42195	Star Voltage L2-N InterHarmonic #25	Float [32b-LSW]	R	
42197	Star Voltage L2-N InterHarmonic #26	Float [32b-LSW]	R	
42199	Star Voltage L2-N InterHarmonic #27	Float [32b-LSW]	R	
42201	Star Voltage L2-N InterHarmonic #28	Float [32b-LSW]	R	
42203	Star Voltage L2-N InterHarmonic #29	Float [32b-LSW]	R	
42205	Star Voltage L2-N InterHarmonic #30	Float [32b-LSW]	R	
42207	Star Voltage L2-N InterHarmonic #31	Float [32b-LSW]	R	
42209	Star Voltage L2-N InterHarmonic #32	Float [32b-LSW]	R	
42211	Star Voltage L2-N InterHarmonic #33	Float [32b-LSW]	R	
42213	Star Voltage L2-N InterHarmonic #34	Float [32b-LSW]	R	
42215	Star Voltage L2-N InterHarmonic #35	Float [32b-LSW]	R	
42217	Star Voltage L2-N InterHarmonic #36	Float [32b-LSW]	R	
42219	Star Voltage L2-N InterHarmonic #37	Float [32b-LSW]	R	
42221	Star Voltage L2-N InterHarmonic #38	Float [32b-LSW]	R	
42223	Star Voltage L2-N InterHarmonic #39	Float [32b-LSW]	R	
42225	Star Voltage L2-N InterHarmonic #40	Float [32b-LSW]	R	
42227	Star Voltage L2-N InterHarmonic #41	Float [32b-LSW]	R	
42229	Star Voltage L2-N InterHarmonic #42	Float [32b-LSW]	R	
42231	Star Voltage L2-N InterHarmonic #43	Float [32b-LSW]	R	
42233	Star Voltage L2-N InterHarmonic #44	Float [32b-LSW]	R	
42235	Star Voltage L2-N InterHarmonic #45	Float [32b-LSW]	R	
42237	Star Voltage L2-N InterHarmonic #46	Float [32b-LSW]	R	
42239	Star Voltage L2-N InterHarmonic #47	Float [32b-LSW]	R	
42241	Star Voltage L2-N InterHarmonic #48	Float [32b-LSW]	R	
42243	Star Voltage L2-N InterHarmonic #49	Float [32b-LSW]	R	



Address Modbus	Description	Register Type	R/W	Default
42245	Star Voltage L2-N InterHarmonic #50	Float [32b-LSW]	R	
42247	Star Voltage L2-N InterHarmonic #51	Float [32b-LSW]	R	
42249	Star Voltage L2-N InterHarmonic #52	Float [32b-LSW]	R	
42251	Star Voltage L2-N InterHarmonic #53	Float [32b-LSW]	R	
42253	Star Voltage L2-N InterHarmonic #54	Float [32b-LSW]	R	
42255	Star Voltage L2-N InterHarmonic #55	Float [32b-LSW]	R	
42257	Star Voltage L2-N InterHarmonic #56	Float [32b-LSW]	R	
42259	Star Voltage L2-N InterHarmonic #57	Float [32b-LSW]	R	
42261	Star Voltage L2-N InterHarmonic #58	Float [32b-LSW]	R	
42263	Star Voltage L2-N InterHarmonic #59	Float [32b-LSW]	R	
42265	Star Voltage L2-N InterHarmonic #60	Float [32b-LSW]	R	
42267	Star Voltage L2-N InterHarmonic #61	Float [32b-LSW]	R	
42269	Star Voltage L2-N InterHarmonic #62	Float [32b-LSW]	R	
42271	Star Voltage L2-N InterHarmonic #63	Float [32b-LSW]	R	
42273	Star Voltage L3-N InterHarmonic #0	Float [32b-LSW]	R	
42275	Star Voltage L3-N InterHarmonic #1	Float [32b-LSW]	R	
42277	Star Voltage L3-N InterHarmonic #2	Float [32b-LSW]	R	
42279	Star Voltage L3-N InterHarmonic #3	Float [32b-LSW]	R	
42281	Star Voltage L3-N InterHarmonic #4	Float [32b-LSW]	R	
42283	Star Voltage L3-N InterHarmonic #5	Float [32b-LSW]	R	
42285	Star Voltage L3-N InterHarmonic #6	Float [32b-LSW]	R	
42287	Star Voltage L3-N InterHarmonic #7	Float [32b-LSW]	R	
42289	Star Voltage L3-N InterHarmonic #8	Float [32b-LSW]	R	
42291	Star Voltage L3-N InterHarmonic #9	Float [32b-LSW]	R	
42293	Star Voltage L3-N InterHarmonic #10	Float [32b-LSW]	R	
42295	Star Voltage L3-N InterHarmonic #11	Float [32b-LSW]	R	
42297	Star Voltage L3-N InterHarmonic #12	Float [32b-LSW]	R	
42299	Star Voltage L3-N InterHarmonic #13	Float [32b-LSW]	R	
42301	Star Voltage L3-N InterHarmonic #14	Float [32b-LSW]	R	
42303	Star Voltage L3-N InterHarmonic #15	Float [32b-LSW]	R	
42305	Star Voltage L3-N InterHarmonic #16	Float [32b-LSW]	R	
42307	Star Voltage L3-N InterHarmonic #17	Float [32b-LSW]	R	
42309	Star Voltage L3-N InterHarmonic #18	Float [32b-LSW]	R	
42311	Star Voltage L3-N InterHarmonic #19	Float [32b-LSW]	R	
42313	Star Voltage L3-N InterHarmonic #20	Float [32b-LSW]	R	
42315	Star Voltage L3-N InterHarmonic #21	Float [32b-LSW]	R	
42317	Star Voltage L3-N InterHarmonic #22	Float [32b-LSW]	R	
42319	Star Voltage L3-N InterHarmonic #23	Float [32b-LSW]	R	
42321	Star Voltage L3-N InterHarmonic #24	Float [32b-LSW]	R	
42323	Star Voltage L3-N InterHarmonic #25	Float [32b-LSW]	R	
42325	Star Voltage L3-N InterHarmonic #26	Float [32b-LSW]	R	
42327	Star Voltage L3-N InterHarmonic #27	Float [32b-LSW]	R	
42329	Star Voltage L3-N InterHarmonic #28	Float [32b-LSW]	R	
42331	Star Voltage L3-N InterHarmonic #29	Float [32b-LSW]	R	
42333	Star Voltage L3-N InterHarmonic #30	Float [32b-LSW]	R	
42335	Star Voltage L3-N InterHarmonic #31	Float [32b-LSW]	R	
42337	Star Voltage L3-N InterHarmonic #32	Float [32b-LSW]	R	
42339	Star Voltage L3-N InterHarmonic #33	Float [32b-LSW]	R	
42341	Star Voltage L3-N InterHarmonic #34	Float [32b-LSW]	R	
42343	Star Voltage L3-N InterHarmonic #35	Float [32b-LSW]	R	
42345	Star Voltage L3-N InterHarmonic #36	Float [32b-LSW]	R	
42347	Star Voltage L3-N InterHarmonic #37	Float [32b-LSW]	R	
42349	Star Voltage L3-N InterHarmonic #38	Float [32b-LSW]	R	
42351	Star Voltage L3-N InterHarmonic #39	Float [32b-LSW]	R	
42353	Star Voltage L3-N InterHarmonic #40	Float [32b-LSW]	R	
42355	Star Voltage L3-N InterHarmonic #41	Float [32b-LSW]	R	
42357	Star Voltage L3-N InterHarmonic #42	Float [32b-LSW]	R	
42359	Star Voltage L3-N InterHarmonic #43	Float [32b-LSW]	R	
42361	Star Voltage L3-N InterHarmonic #44	Float [32b-LSW]	R	
42363	Star Voltage L3-N InterHarmonic #45	Float [32b-LSW]	R	
42365	Star Voltage L3-N InterHarmonic #46	Float [32b-LSW]	R	
42367	Star Voltage L3-N InterHarmonic #47	Float [32b-LSW]	R	
42369	Star Voltage L3-N InterHarmonic #48	Float [32b-LSW]	R	



Address Modbus	Description	Register Type	R/W	Default
42371	Star Voltage L3-N InterHarmonic #49	Float [32b-LSW]	R	
42373	Star Voltage L3-N InterHarmonic #50	Float [32b-LSW]	R	
42375	Star Voltage L3-N InterHarmonic #51	Float [32b-LSW]	R	
42377	Star Voltage L3-N InterHarmonic #52	Float [32b-LSW]	R	
42379	Star Voltage L3-N InterHarmonic #53	Float [32b-LSW]	R	
42381	Star Voltage L3-N InterHarmonic #54	Float [32b-LSW]	R	
42383	Star Voltage L3-N InterHarmonic #55	Float [32b-LSW]	R	
42385	Star Voltage L3-N InterHarmonic #56	Float [32b-LSW]	R	
42387	Star Voltage L3-N InterHarmonic #57	Float [32b-LSW]	R	
42389	Star Voltage L3-N InterHarmonic #58	Float [32b-LSW]	R	
42391	Star Voltage L3-N InterHarmonic #59	Float [32b-LSW]	R	
42393	Star Voltage L3-N InterHarmonic #60	Float [32b-LSW]	R	
42395	Star Voltage L3-N InterHarmonic #61	Float [32b-LSW]	R	
42397	Star Voltage L3-N InterHarmonic #62	Float [32b-LSW]	R	
42399	Star Voltage L3-N InterHarmonic #63	Float [32b-LSW]	R	
42401	Line Voltage L1-L2 InterHarmonic #0	Float [32b-LSW]	R	
42403	Line Voltage L1-L2 InterHarmonic #1	Float [32b-LSW]	R	
42405	Line Voltage L1-L2 InterHarmonic #2	Float [32b-LSW]	R	
42407	Line Voltage L1-L2 InterHarmonic #3	Float [32b-LSW]	R	
42409	Line Voltage L1-L2 InterHarmonic #4	Float [32b-LSW]	R	
42411	Line Voltage L1-L2 InterHarmonic #5	Float [32b-LSW]	R	
42413	Line Voltage L1-L2 InterHarmonic #6	Float [32b-LSW]	R	
42415	Line Voltage L1-L2 InterHarmonic #7	Float [32b-LSW]	R	
42417	Line Voltage L1-L2 InterHarmonic #8	Float [32b-LSW]	R	
42419	Line Voltage L1-L2 InterHarmonic #9	Float [32b-LSW]	R	
42421	Line Voltage L1-L2 InterHarmonic #10	Float [32b-LSW]	R	
42423	Line Voltage L1-L2 InterHarmonic #11	Float [32b-LSW]	R	
42425	Line Voltage L1-L2 InterHarmonic #12	Float [32b-LSW]	R	
42427	Line Voltage L1-L2 InterHarmonic #13	Float [32b-LSW]	R	
42429	Line Voltage L1-L2 InterHarmonic #14	Float [32b-LSW]	R	
42431	Line Voltage L1-L2 InterHarmonic #15	Float [32b-LSW]	R	
42433	Line Voltage L1-L2 InterHarmonic #16	Float [32b-LSW]	R	
42435	Line Voltage L1-L2 InterHarmonic #17	Float [32b-LSW]	R	
42437	Line Voltage L1-L2 InterHarmonic #18	Float [32b-LSW]	R	
42439	Line Voltage L1-L2 InterHarmonic #19	Float [32b-LSW]	R	
42441	Line Voltage L1-L2 InterHarmonic #20	Float [32b-LSW]	R	
42443	Line Voltage L1-L2 InterHarmonic #21	Float [32b-LSW]	R	
42445	Line Voltage L1-L2 InterHarmonic #22	Float [32b-LSW]	R	
42447	Line Voltage L1-L2 InterHarmonic #23	Float [32b-LSW]	R	
42449	Line Voltage L1-L2 InterHarmonic #24	Float [32b-LSW]	R	
42451	Line Voltage L1-L2 InterHarmonic #25	Float [32b-LSW]	R	
42453	Line Voltage L1-L2 InterHarmonic #26	Float [32b-LSW]	R	
42455	Line Voltage L1-L2 InterHarmonic #27	Float [32b-LSW]	R	
42457	Line Voltage L1-L2 InterHarmonic #28	Float [32b-LSW]	R	
42459	Line Voltage L1-L2 InterHarmonic #29	Float [32b-LSW]	R	
42461	Line Voltage L1-L2 InterHarmonic #30	Float [32b-LSW]	R	
42463	Line Voltage L1-L2 InterHarmonic #31	Float [32b-LSW]	R	
42465	Line Voltage L1-L2 InterHarmonic #32	Float [32b-LSW]	R	
42467	Line Voltage L1-L2 InterHarmonic #33	Float [32b-LSW]	R	
42469	Line Voltage L1-L2 InterHarmonic #34	Float [32b-LSW]	R	
42471	Line Voltage L1-L2 InterHarmonic #35	Float [32b-LSW]	R	
42473	Line Voltage L1-L2 InterHarmonic #36	Float [32b-LSW]	R	
42475	Line Voltage L1-L2 InterHarmonic #37	Float [32b-LSW]	R	
42477	Line Voltage L1-L2 InterHarmonic #38	Float [32b-LSW]	R	
42479	Line Voltage L1-L2 InterHarmonic #39	Float [32b-LSW]	R	
42481	Line Voltage L1-L2 InterHarmonic #40	Float [32b-LSW]	R	
42483	Line Voltage L1-L2 InterHarmonic #41	Float [32b-LSW]	R	
42485	Line Voltage L1-L2 InterHarmonic #42	Float [32b-LSW]	R	
42487	Line Voltage L1-L2 InterHarmonic #43	Float [32b-LSW]	R	
42489	Line Voltage L1-L2 InterHarmonic #44	Float [32b-LSW]	R	
42491	Line Voltage L1-L2 InterHarmonic #45	Float [32b-LSW]	R	
42493	Line Voltage L1-L2 InterHarmonic #46	Float [32b-LSW]	R	
42495	Line Voltage L1-L2 InterHarmonic #47	Float [32b-LSW]	R	



Address Modbus	Description	Register Type	R/W	Default
42497	Line Voltage L1-L2 InterHarmonic #48	Float [32b-LSW]	R	
42499	Line Voltage L1-L2 InterHarmonic #49	Float [32b-LSW]	R	
42501	Line Voltage L1-L2 InterHarmonic #50	Float [32b-LSW]	R	
42503	Line Voltage L1-L2 InterHarmonic #51	Float [32b-LSW]	R	
42505	Line Voltage L1-L2 InterHarmonic #52	Float [32b-LSW]	R	
42507	Line Voltage L1-L2 InterHarmonic #53	Float [32b-LSW]	R	
42509	Line Voltage L1-L2 InterHarmonic #54	Float [32b-LSW]	R	
42511	Line Voltage L1-L2 InterHarmonic #55	Float [32b-LSW]	R	
42513	Line Voltage L1-L2 InterHarmonic #56	Float [32b-LSW]	R	
42515	Line Voltage L1-L2 InterHarmonic #57	Float [32b-LSW]	R	
42517	Line Voltage L1-L2 InterHarmonic #58	Float [32b-LSW]	R	
42519	Line Voltage L1-L2 InterHarmonic #59	Float [32b-LSW]	R	
42521	Line Voltage L1-L2 InterHarmonic #60	Float [32b-LSW]	R	
42523	Line Voltage L1-L2 InterHarmonic #61	Float [32b-LSW]	R	
42525	Line Voltage L1-L2 InterHarmonic #62	Float [32b-LSW]	R	
42527	Line Voltage L1-L2 InterHarmonic #63	Float [32b-LSW]	R	
42529	Line Voltage L2-L3 InterHarmonic #0	Float [32b-LSW]	R	
42531	Line Voltage L2-L3 InterHarmonic #1	Float [32b-LSW]	R	
42533	Line Voltage L2-L3 InterHarmonic #2	Float [32b-LSW]	R	
42535	Line Voltage L2-L3 InterHarmonic #3	Float [32b-LSW]	R	
42537	Line Voltage L2-L3 InterHarmonic #4	Float [32b-LSW]	R	
42539	Line Voltage L2-L3 InterHarmonic #5	Float [32b-LSW]	R	
42541	Line Voltage L2-L3 InterHarmonic #6	Float [32b-LSW]	R	
42543	Line Voltage L2-L3 InterHarmonic #7	Float [32b-LSW]	R	
42545	Line Voltage L2-L3 InterHarmonic #8	Float [32b-LSW]	R	
42547	Line Voltage L2-L3 InterHarmonic #9	Float [32b-LSW]	R	
42549	Line Voltage L2-L3 InterHarmonic #10	Float [32b-LSW]	R	
42551	Line Voltage L2-L3 InterHarmonic #11	Float [32b-LSW]	R	
42553	Line Voltage L2-L3 InterHarmonic #12	Float [32b-LSW]	R	
42555	Line Voltage L2-L3 InterHarmonic #13	Float [32b-LSW]	R	
42557	Line Voltage L2-L3 InterHarmonic #14	Float [32b-LSW]	R	
42559	Line Voltage L2-L3 InterHarmonic #15	Float [32b-LSW]	R	
42561	Line Voltage L2-L3 InterHarmonic #16	Float [32b-LSW]	R	
42563	Line Voltage L2-L3 InterHarmonic #17	Float [32b-LSW]	R	
42565	Line Voltage L2-L3 InterHarmonic #18	Float [32b-LSW]	R	
42567	Line Voltage L2-L3 InterHarmonic #19	Float [32b-LSW]	R	
42569	Line Voltage L2-L3 InterHarmonic #20	Float [32b-LSW]	R	
42571	Line Voltage L2-L3 InterHarmonic #21	Float [32b-LSW]	R	
42573	Line Voltage L2-L3 InterHarmonic #22	Float [32b-LSW]	R	
42575	Line Voltage L2-L3 InterHarmonic #23	Float [32b-LSW]	R	
42577	Line Voltage L2-L3 InterHarmonic #24	Float [32b-LSW]	R	
42579	Line Voltage L2-L3 InterHarmonic #25	Float [32b-LSW]	R	
42581	Line Voltage L2-L3 InterHarmonic #26	Float [32b-LSW]	R	
42583	Line Voltage L2-L3 InterHarmonic #27	Float [32b-LSW]	R	
42585	Line Voltage L2-L3 InterHarmonic #28	Float [32b-LSW]	R	
42587	Line Voltage L2-L3 InterHarmonic #29	Float [32b-LSW]	R	
42589	Line Voltage L2-L3 InterHarmonic #30	Float [32b-LSW]	R	
42591	Line Voltage L2-L3 InterHarmonic #31	Float [32b-LSW]	R	
42593	Line Voltage L2-L3 InterHarmonic #32	Float [32b-LSW]	R	
42595	Line Voltage L2-L3 InterHarmonic #33	Float [32b-LSW]	R	
42597	Line Voltage L2-L3 InterHarmonic #34	Float [32b-LSW]	R	
42599	Line Voltage L2-L3 InterHarmonic #35	Float [32b-LSW]	R	
42601	Line Voltage L2-L3 InterHarmonic #36	Float [32b-LSW]	R	
42603	Line Voltage L2-L3 InterHarmonic #37	Float [32b-LSW]	R	
42605	Line Voltage L2-L3 InterHarmonic #38	Float [32b-LSW]	R	
42607	Line Voltage L2-L3 InterHarmonic #39	Float [32b-LSW]	R	
42609	Line Voltage L2-L3 InterHarmonic #40	Float [32b-LSW]	R	
42611	Line Voltage L2-L3 InterHarmonic #41	Float [32b-LSW]	R	
42613	Line Voltage L2-L3 InterHarmonic #42	Float [32b-LSW]	R	
42615	Line Voltage L2-L3 InterHarmonic #43	Float [32b-LSW]	R	
42617	Line Voltage L2-L3 InterHarmonic #44	Float [32b-LSW]	R	
42619	Line Voltage L2-L3 InterHarmonic #45	Float [32b-LSW]	R	
42621	Line Voltage L2-L3 InterHarmonic #46	Float [32b-LSW]	R	



Address Modbus	Description	Register Type	R/W	Default
42623	Line Voltage L2-L3 InterHarmonic #47	Float [32b-LSW]	R	
42625	Line Voltage L2-L3 InterHarmonic #48	Float [32b-LSW]	R	
42627	Line Voltage L2-L3 InterHarmonic #49	Float [32b-LSW]	R	
42629	Line Voltage L2-L3 InterHarmonic #50	Float [32b-LSW]	R	
42631	Line Voltage L2-L3 InterHarmonic #51	Float [32b-LSW]	R	
42633	Line Voltage L2-L3 InterHarmonic #52	Float [32b-LSW]	R	
42635	Line Voltage L2-L3 InterHarmonic #53	Float [32b-LSW]	R	
42637	Line Voltage L2-L3 InterHarmonic #54	Float [32b-LSW]	R	
42639	Line Voltage L2-L3 InterHarmonic #55	Float [32b-LSW]	R	
42641	Line Voltage L2-L3 InterHarmonic #56	Float [32b-LSW]	R	
42643	Line Voltage L2-L3 InterHarmonic #57	Float [32b-LSW]	R	
42645	Line Voltage L2-L3 InterHarmonic #58	Float [32b-LSW]	R	
42647	Line Voltage L2-L3 InterHarmonic #59	Float [32b-LSW]	R	
42649	Line Voltage L2-L3 InterHarmonic #60	Float [32b-LSW]	R	
42651	Line Voltage L2-L3 InterHarmonic #61	Float [32b-LSW]	R	
42653	Line Voltage L2-L3 InterHarmonic #62	Float [32b-LSW]	R	
42655	Line Voltage L2-L3 InterHarmonic #63	Float [32b-LSW]	R	
42657	Line Voltage L3-L1 InterHarmonic #0	Float [32b-LSW]	R	
42659	Line Voltage L3-L1 InterHarmonic #1	Float [32b-LSW]	R	
42661	Line Voltage L3-L1 InterHarmonic #2	Float [32b-LSW]	R	
42663	Line Voltage L3-L1 InterHarmonic #3	Float [32b-LSW]	R	
42665	Line Voltage L3-L1 InterHarmonic #4	Float [32b-LSW]	R	
42667	Line Voltage L3-L1 InterHarmonic #5	Float [32b-LSW]	R	
42669	Line Voltage L3-L1 InterHarmonic #6	Float [32b-LSW]	R	
42671	Line Voltage L3-L1 InterHarmonic #7	Float [32b-LSW]	R	
42673	Line Voltage L3-L1 InterHarmonic #8	Float [32b-LSW]	R	
42675	Line Voltage L3-L1 InterHarmonic #9	Float [32b-LSW]	R	
42677	Line Voltage L3-L1 InterHarmonic #10	Float [32b-LSW]	R	
42679	Line Voltage L3-L1 InterHarmonic #11	Float [32b-LSW]	R	
42681	Line Voltage L3-L1 InterHarmonic #12	Float [32b-LSW]	R	
42683	Line Voltage L3-L1 InterHarmonic #13	Float [32b-LSW]	R	
42685	Line Voltage L3-L1 InterHarmonic #14	Float [32b-LSW]	R	
42687	Line Voltage L3-L1 InterHarmonic #15	Float [32b-LSW]	R	
42689	Line Voltage L3-L1 InterHarmonic #16	Float [32b-LSW]	R	
42691	Line Voltage L3-L1 InterHarmonic #17	Float [32b-LSW]	R	
42693	Line Voltage L3-L1 InterHarmonic #18	Float [32b-LSW]	R	
42695	Line Voltage L3-L1 InterHarmonic #19	Float [32b-LSW]	R	
42697	Line Voltage L3-L1 InterHarmonic #20	Float [32b-LSW]	R	
42699	Line Voltage L3-L1 InterHarmonic #21	Float [32b-LSW]	R	
42701	Line Voltage L3-L1 InterHarmonic #22	Float [32b-LSW]	R	
42703	Line Voltage L3-L1 InterHarmonic #23	Float [32b-LSW]	R	
42705	Line Voltage L3-L1 InterHarmonic #24	Float [32b-LSW]	R	
42707	Line Voltage L3-L1 InterHarmonic #25	Float [32b-LSW]	R	
42709	Line Voltage L3-L1 InterHarmonic #26	Float [32b-LSW]	R	
42711	Line Voltage L3-L1 InterHarmonic #27	Float [32b-LSW]	R	
42713	Line Voltage L3-L1 InterHarmonic #28	Float [32b-LSW]	R	
42715	Line Voltage L3-L1 InterHarmonic #29	Float [32b-LSW]	R	
42717	Line Voltage L3-L1 InterHarmonic #30	Float [32b-LSW]	R	
42719	Line Voltage L3-L1 InterHarmonic #31	Float [32b-LSW]	R	
42721	Line Voltage L3-L1 InterHarmonic #32	Float [32b-LSW]	R	
42723	Line Voltage L3-L1 InterHarmonic #33	Float [32b-LSW]	R	
42725	Line Voltage L3-L1 InterHarmonic #34	Float [32b-LSW]	R	
42727	Line Voltage L3-L1 InterHarmonic #35	Float [32b-LSW]	R	
42729	Line Voltage L3-L1 InterHarmonic #36	Float [32b-LSW]	R	
42731	Line Voltage L3-L1 InterHarmonic #37	Float [32b-LSW]	R	
42733	Line Voltage L3-L1 InterHarmonic #38	Float [32b-LSW]	R	
42735	Line Voltage L3-L1 InterHarmonic #39	Float [32b-LSW]	R	
42737	Line Voltage L3-L1 InterHarmonic #40	Float [32b-LSW]	R	
42739	Line Voltage L3-L1 InterHarmonic #41	Float [32b-LSW]	R	
42741	Line Voltage L3-L1 InterHarmonic #42	Float [32b-LSW]	R	
42743	Line Voltage L3-L1 InterHarmonic #43	Float [32b-LSW]	R	
42745	Line Voltage L3-L1 InterHarmonic #44	Float [32b-LSW]	R	
42747	Line Voltage L3-L1 InterHarmonic #45	Float [32b-LSW]	R	



Address Modbus	Description	Register Type	R/W	Default
42749	Line Voltage L3-L1 InterHarmonic #46	Float [32b-LSW]	R	
42751	Line Voltage L3-L1 InterHarmonic #47	Float [32b-LSW]	R	
42753	Line Voltage L3-L1 InterHarmonic #48	Float [32b-LSW]	R	
42755	Line Voltage L3-L1 InterHarmonic #49	Float [32b-LSW]	R	
42757	Line Voltage L3-L1 InterHarmonic #50	Float [32b-LSW]	R	
42759	Line Voltage L3-L1 InterHarmonic #51	Float [32b-LSW]	R	
42761	Line Voltage L3-L1 InterHarmonic #52	Float [32b-LSW]	R	
42763	Line Voltage L3-L1 InterHarmonic #53	Float [32b-LSW]	R	
42765	Line Voltage L3-L1 InterHarmonic #54	Float [32b-LSW]	R	
42767	Line Voltage L3-L1 InterHarmonic #55	Float [32b-LSW]	R	
42769	Line Voltage L3-L1 InterHarmonic #56	Float [32b-LSW]	R	
42771	Line Voltage L3-L1 InterHarmonic #57	Float [32b-LSW]	R	
42773	Line Voltage L3-L1 InterHarmonic #58	Float [32b-LSW]	R	
42775	Line Voltage L3-L1 InterHarmonic #59	Float [32b-LSW]	R	
42777	Line Voltage L3-L1 InterHarmonic #60	Float [32b-LSW]	R	
42779	Line Voltage L3-L1 InterHarmonic #61	Float [32b-LSW]	R	
42781	Line Voltage L3-L1 InterHarmonic #62	Float [32b-LSW]	R	
42783	Line Voltage L3-L1 InterHarmonic #63	Float [32b-LSW]	R	
42785	Line Current L1 InterHarmonic #0	Float [32b-LSW]	R	
42787	Line Current L1 InterHarmonic #1	Float [32b-LSW]	R	
42789	Line Current L1 InterHarmonic #2	Float [32b-LSW]	R	
42791	Line Current L1 InterHarmonic #3	Float [32b-LSW]	R	
42793	Line Current L1 InterHarmonic #4	Float [32b-LSW]	R	
42795	Line Current L1 InterHarmonic #5	Float [32b-LSW]	R	
42797	Line Current L1 InterHarmonic #6	Float [32b-LSW]	R	
42799	Line Current L1 InterHarmonic #7	Float [32b-LSW]	R	
42801	Line Current L1 InterHarmonic #8	Float [32b-LSW]	R	
42803	Line Current L1 InterHarmonic #9	Float [32b-LSW]	R	
42805	Line Current L1 InterHarmonic #10	Float [32b-LSW]	R	
42807	Line Current L1 InterHarmonic #11	Float [32b-LSW]	R	
42809	Line Current L1 InterHarmonic #12	Float [32b-LSW]	R	
42811	Line Current L1 InterHarmonic #13	Float [32b-LSW]	R	
42813	Line Current L1 InterHarmonic #14	Float [32b-LSW]	R	
42815	Line Current L1 InterHarmonic #15	Float [32b-LSW]	R	
42817	Line Current L1 InterHarmonic #16	Float [32b-LSW]	R	
42819	Line Current L1 InterHarmonic #17	Float [32b-LSW]	R	
42821	Line Current L1 InterHarmonic #18	Float [32b-LSW]	R	
42823	Line Current L1 InterHarmonic #19	Float [32b-LSW]	R	
42825	Line Current L1 InterHarmonic #20	Float [32b-LSW]	R	
42827	Line Current L1 InterHarmonic #21	Float [32b-LSW]	R	
42829	Line Current L1 InterHarmonic #22	Float [32b-LSW]	R	
42831	Line Current L1 InterHarmonic #23	Float [32b-LSW]	R	
42833	Line Current L1 InterHarmonic #24	Float [32b-LSW]	R	
42835	Line Current L1 InterHarmonic #25	Float [32b-LSW]	R	
42837	Line Current L1 InterHarmonic #26	Float [32b-LSW]	R	
42839	Line Current L1 InterHarmonic #27	Float [32b-LSW]	R	
42841	Line Current L1 InterHarmonic #28	Float [32b-LSW]	R	
42843	Line Current L1 InterHarmonic #29	Float [32b-LSW]	R	
42845	Line Current L1 InterHarmonic #30	Float [32b-LSW]	R	
42847	Line Current L1 InterHarmonic #31	Float [32b-LSW]	R	
42849	Line Current L1 InterHarmonic #32	Float [32b-LSW]	R	
42851	Line Current L1 InterHarmonic #33	Float [32b-LSW]	R	
42853	Line Current L1 InterHarmonic #34	Float [32b-LSW]	R	
42855	Line Current L1 InterHarmonic #35	Float [32b-LSW]	R	
42857	Line Current L1 InterHarmonic #36	Float [32b-LSW]	R	
42859	Line Current L1 InterHarmonic #37	Float [32b-LSW]	R	
42861	Line Current L1 InterHarmonic #38	Float [32b-LSW]	R	
42863	Line Current L1 InterHarmonic #39	Float [32b-LSW]	R	
42865	Line Current L1 InterHarmonic #40	Float [32b-LSW]	R	
42867	Line Current L1 InterHarmonic #41	Float [32b-LSW]	R	
42869	Line Current L1 InterHarmonic #42	Float [32b-LSW]	R	
42871	Line Current L1 InterHarmonic #43	Float [32b-LSW]	R	
42873	Line Current L1 InterHarmonic #44	Float [32b-LSW]	R	



Address Modbus	Description	Register Type	R/W	Default
42875	Line Current L1 InterHarmonic #45	Float [32b-LSW]	R	
42877	Line Current L1 InterHarmonic #46	Float [32b-LSW]	R	
42879	Line Current L1 InterHarmonic #47	Float [32b-LSW]	R	
42881	Line Current L1 InterHarmonic #48	Float [32b-LSW]	R	
42883	Line Current L1 InterHarmonic #49	Float [32b-LSW]	R	
42885	Line Current L1 InterHarmonic #50	Float [32b-LSW]	R	
42887	Line Current L1 InterHarmonic #51	Float [32b-LSW]	R	
42889	Line Current L1 InterHarmonic #52	Float [32b-LSW]	R	
42891	Line Current L1 InterHarmonic #53	Float [32b-LSW]	R	
42893	Line Current L1 InterHarmonic #54	Float [32b-LSW]	R	
42895	Line Current L1 InterHarmonic #55	Float [32b-LSW]	R	
42897	Line Current L1 InterHarmonic #56	Float [32b-LSW]	R	
42899	Line Current L1 InterHarmonic #57	Float [32b-LSW]	R	
42901	Line Current L1 InterHarmonic #58	Float [32b-LSW]	R	
42903	Line Current L1 InterHarmonic #59	Float [32b-LSW]	R	
42905	Line Current L1 InterHarmonic #60	Float [32b-LSW]	R	
42907	Line Current L1 InterHarmonic #61	Float [32b-LSW]	R	
42909	Line Current L1 InterHarmonic #62	Float [32b-LSW]	R	
42911	Line Current L1 InterHarmonic #63	Float [32b-LSW]	R	
42913	Line Current L2 InterHarmonic #0	Float [32b-LSW]	R	
42915	Line Current L2 InterHarmonic #1	Float [32b-LSW]	R	
42917	Line Current L2 InterHarmonic #2	Float [32b-LSW]	R	
42919	Line Current L2 InterHarmonic #3	Float [32b-LSW]	R	
42921	Line Current L2 InterHarmonic #4	Float [32b-LSW]	R	
42923	Line Current L2 InterHarmonic #5	Float [32b-LSW]	R	
42925	Line Current L2 InterHarmonic #6	Float [32b-LSW]	R	
42927	Line Current L2 InterHarmonic #7	Float [32b-LSW]	R	
42929	Line Current L2 InterHarmonic #8	Float [32b-LSW]	R	
42931	Line Current L2 InterHarmonic #9	Float [32b-LSW]	R	
42933	Line Current L2 InterHarmonic #10	Float [32b-LSW]	R	
42935	Line Current L2 InterHarmonic #11	Float [32b-LSW]	R	
42937	Line Current L2 InterHarmonic #12	Float [32b-LSW]	R	
42939	Line Current L2 InterHarmonic #13	Float [32b-LSW]	R	
42941	Line Current L2 InterHarmonic #14	Float [32b-LSW]	R	
42943	Line Current L2 InterHarmonic #15	Float [32b-LSW]	R	
42945	Line Current L2 InterHarmonic #16	Float [32b-LSW]	R	
42947	Line Current L2 InterHarmonic #17	Float [32b-LSW]	R	
42949	Line Current L2 InterHarmonic #18	Float [32b-LSW]	R	
42951	Line Current L2 InterHarmonic #19	Float [32b-LSW]	R	
42953	Line Current L2 InterHarmonic #20	Float [32b-LSW]	R	
42955	Line Current L2 InterHarmonic #21	Float [32b-LSW]	R	
42957	Line Current L2 InterHarmonic #22	Float [32b-LSW]	R	
42959	Line Current L2 InterHarmonic #23	Float [32b-LSW]	R	
42961	Line Current L2 InterHarmonic #24	Float [32b-LSW]	R	
42963	Line Current L2 InterHarmonic #25	Float [32b-LSW]	R	
42965	Line Current L2 InterHarmonic #26	Float [32b-LSW]	R	
42967	Line Current L2 InterHarmonic #27	Float [32b-LSW]	R	
42969	Line Current L2 InterHarmonic #28	Float [32b-LSW]	R	
42971	Line Current L2 InterHarmonic #29	Float [32b-LSW]	R	
42973	Line Current L2 InterHarmonic #30	Float [32b-LSW]	R	
42975	Line Current L2 InterHarmonic #31	Float [32b-LSW]	R	
42977	Line Current L2 InterHarmonic #32	Float [32b-LSW]	R	
42979	Line Current L2 InterHarmonic #33	Float [32b-LSW]	R	
42981	Line Current L2 InterHarmonic #34	Float [32b-LSW]	R	
42983	Line Current L2 InterHarmonic #35	Float [32b-LSW]	R	
42985	Line Current L2 InterHarmonic #36	Float [32b-LSW]	R	
42987	Line Current L2 InterHarmonic #37	Float [32b-LSW]	R	
42989	Line Current L2 InterHarmonic #38	Float [32b-LSW]	R	
42991	Line Current L2 InterHarmonic #39	Float [32b-LSW]	R	
42993	Line Current L2 InterHarmonic #40	Float [32b-LSW]	R	
42995	Line Current L2 InterHarmonic #41	Float [32b-LSW]	R	
42997	Line Current L2 InterHarmonic #42	Float [32b-LSW]	R	
42999	Line Current L2 InterHarmonic #43	Float [32b-LSW]	R	
43001	Line Current L2 InterHarmonic #44	Float [32b-LSW]	R	



Address Modbus	Description	Register Type	R/W	Default
43003	Line Current L2 InterHarmonic #45	Float [32b-LSW]	R	
43005	Line Current L2 InterHarmonic #46	Float [32b-LSW]	R	
43007	Line Current L2 InterHarmonic #47	Float [32b-LSW]	R	
43009	Line Current L2 InterHarmonic #48	Float [32b-LSW]	R	
43011	Line Current L2 InterHarmonic #49	Float [32b-LSW]	R	
43013	Line Current L2 InterHarmonic #50	Float [32b-LSW]	R	
43015	Line Current L2 InterHarmonic #51	Float [32b-LSW]	R	
43017	Line Current L2 InterHarmonic #52	Float [32b-LSW]	R	
43019	Line Current L2 InterHarmonic #53	Float [32b-LSW]	R	
43021	Line Current L2 InterHarmonic #54	Float [32b-LSW]	R	
43023	Line Current L2 InterHarmonic #55	Float [32b-LSW]	R	
43025	Line Current L2 InterHarmonic #56	Float [32b-LSW]	R	
43027	Line Current L2 InterHarmonic #57	Float [32b-LSW]	R	
43029	Line Current L2 InterHarmonic #58	Float [32b-LSW]	R	
43031	Line Current L2 InterHarmonic #59	Float [32b-LSW]	R	
43033	Line Current L2 InterHarmonic #60	Float [32b-LSW]	R	
43035	Line Current L2 InterHarmonic #61	Float [32b-LSW]	R	
43037	Line Current L2 InterHarmonic #62	Float [32b-LSW]	R	
43039	Line Current L2 InterHarmonic #63	Float [32b-LSW]	R	
43041	Line Current L3 InterHarmonic #0	Float [32b-LSW]	R	
43043	Line Current L3 InterHarmonic #1	Float [32b-LSW]	R	
43045	Line Current L3 InterHarmonic #2	Float [32b-LSW]	R	
43047	Line Current L3 InterHarmonic #3	Float [32b-LSW]	R	
43049	Line Current L3 InterHarmonic #4	Float [32b-LSW]	R	
43051	Line Current L3 InterHarmonic #5	Float [32b-LSW]	R	
43053	Line Current L3 InterHarmonic #6	Float [32b-LSW]	R	
43055	Line Current L3 InterHarmonic #7	Float [32b-LSW]	R	
43057	Line Current L3 InterHarmonic #8	Float [32b-LSW]	R	
43059	Line Current L3 InterHarmonic #9	Float [32b-LSW]	R	
43061	Line Current L3 InterHarmonic #10	Float [32b-LSW]	R	
43063	Line Current L3 InterHarmonic #11	Float [32b-LSW]	R	
43065	Line Current L3 InterHarmonic #12	Float [32b-LSW]	R	
43067	Line Current L3 InterHarmonic #13	Float [32b-LSW]	R	
43069	Line Current L3 InterHarmonic #14	Float [32b-LSW]	R	
43071	Line Current L3 InterHarmonic #15	Float [32b-LSW]	R	
43073	Line Current L3 InterHarmonic #16	Float [32b-LSW]	R	
43075	Line Current L3 InterHarmonic #17	Float [32b-LSW]	R	
43077	Line Current L3 InterHarmonic #18	Float [32b-LSW]	R	
43079	Line Current L3 InterHarmonic #19	Float [32b-LSW]	R	
43081	Line Current L3 InterHarmonic #20	Float [32b-LSW]	R	
43083	Line Current L3 InterHarmonic #21	Float [32b-LSW]	R	
43085	Line Current L3 InterHarmonic #22	Float [32b-LSW]	R	
43087	Line Current L3 InterHarmonic #23	Float [32b-LSW]	R	
43089	Line Current L3 InterHarmonic #24	Float [32b-LSW]	R	
43091	Line Current L3 InterHarmonic #25	Float [32b-LSW]	R	
43093	Line Current L3 InterHarmonic #26	Float [32b-LSW]	R	
43095	Line Current L3 InterHarmonic #27	Float [32b-LSW]	R	
43097	Line Current L3 InterHarmonic #28	Float [32b-LSW]	R	
43099	Line Current L3 InterHarmonic #29	Float [32b-LSW]	R	
43101	Line Current L3 InterHarmonic #30	Float [32b-LSW]	R	
43103	Line Current L3 InterHarmonic #31	Float [32b-LSW]	R	
43105	Line Current L3 InterHarmonic #32	Float [32b-LSW]	R	
43107	Line Current L3 InterHarmonic #33	Float [32b-LSW]	R	
43109	Line Current L3 InterHarmonic #34	Float [32b-LSW]	R	
43111	Line Current L3 InterHarmonic #35	Float [32b-LSW]	R	
43113	Line Current L3 InterHarmonic #36	Float [32b-LSW]	R	
43115	Line Current L3 InterHarmonic #37	Float [32b-LSW]	R	
43117	Line Current L3 InterHarmonic #38	Float [32b-LSW]	R	
43119	Line Current L3 InterHarmonic #39	Float [32b-LSW]	R	
43121	Line Current L3 InterHarmonic #40	Float [32b-LSW]	R	
43123	Line Current L3 InterHarmonic #41	Float [32b-LSW]	R	
43125	Line Current L3 InterHarmonic #42	Float [32b-LSW]	R	
43127	Line Current L3 InterHarmonic #43	Float [32b-LSW]	R	



Address Modbus	Description	Register Type	R/W	Default
43129	Line Current L3 InterHarmonic #44	Float [32b-LSW]	R	
43131	Line Current L3 InterHarmonic #45	Float [32b-LSW]	R	
43133	Line Current L3 InterHarmonic #46	Float [32b-LSW]	R	
43135	Line Current L3 InterHarmonic #47	Float [32b-LSW]	R	
43137	Line Current L3 InterHarmonic #48	Float [32b-LSW]	R	
43139	Line Current L3 InterHarmonic #49	Float [32b-LSW]	R	
43141	Line Current L3 InterHarmonic #50	Float [32b-LSW]	R	
43143	Line Current L3 InterHarmonic #51	Float [32b-LSW]	R	
43145	Line Current L3 InterHarmonic #52	Float [32b-LSW]	R	
43147	Line Current L3 InterHarmonic #53	Float [32b-LSW]	R	
43149	Line Current L3 InterHarmonic #54	Float [32b-LSW]	R	
43151	Line Current L3 InterHarmonic #55	Float [32b-LSW]	R	
43153	Line Current L3 InterHarmonic #56	Float [32b-LSW]	R	
43155	Line Current L3 InterHarmonic #57	Float [32b-LSW]	R	
43157	Line Current L3 InterHarmonic #58	Float [32b-LSW]	R	
43159	Line Current L3 InterHarmonic #59	Float [32b-LSW]	R	
43161	Line Current L3 InterHarmonic #60	Float [32b-LSW]	R	
43163	Line Current L3 InterHarmonic #61	Float [32b-LSW]	R	
43165	Line Current L3 InterHarmonic #62	Float [32b-LSW]	R	
43167	Line Current L3 InterHarmonic #63	Float [32b-LSW]	R	
43169	Line Current N InterHarmonic #0	Float [32b-LSW]	R	
43171	Line Current N InterHarmonic #1	Float [32b-LSW]	R	
43173	Line Current N InterHarmonic #2	Float [32b-LSW]	R	
43175	Line Current N InterHarmonic #3	Float [32b-LSW]	R	
43177	Line Current N InterHarmonic #4	Float [32b-LSW]	R	
43179	Line Current N InterHarmonic #5	Float [32b-LSW]	R	
43181	Line Current N InterHarmonic #6	Float [32b-LSW]	R	
43183	Line Current N InterHarmonic #7	Float [32b-LSW]	R	
43185	Line Current N InterHarmonic #8	Float [32b-LSW]	R	
43187	Line Current N InterHarmonic #9	Float [32b-LSW]	R	
43189	Line Current N InterHarmonic #10	Float [32b-LSW]	R	
43191	Line Current N InterHarmonic #11	Float [32b-LSW]	R	
43193	Line Current N InterHarmonic #12	Float [32b-LSW]	R	
43195	Line Current N InterHarmonic #13	Float [32b-LSW]	R	
43197	Line Current N InterHarmonic #14	Float [32b-LSW]	R	
43199	Line Current N InterHarmonic #15	Float [32b-LSW]	R	
43201	Line Current N InterHarmonic #16	Float [32b-LSW]	R	
43203	Line Current N InterHarmonic #17	Float [32b-LSW]	R	
43205	Line Current N InterHarmonic #18	Float [32b-LSW]	R	
43207	Line Current N InterHarmonic #19	Float [32b-LSW]	R	
43209	Line Current N InterHarmonic #20	Float [32b-LSW]	R	
43211	Line Current N InterHarmonic #21	Float [32b-LSW]	R	
43213	Line Current N InterHarmonic #22	Float [32b-LSW]	R	
43215	Line Current N InterHarmonic #23	Float [32b-LSW]	R	
43217	Line Current N InterHarmonic #24	Float [32b-LSW]	R	
43219	Line Current N InterHarmonic #25	Float [32b-LSW]	R	
43221	Line Current N InterHarmonic #26	Float [32b-LSW]	R	
43223	Line Current N InterHarmonic #27	Float [32b-LSW]	R	
43225	Line Current N InterHarmonic #28	Float [32b-LSW]	R	
43227	Line Current N InterHarmonic #29	Float [32b-LSW]	R	
43229	Line Current N InterHarmonic #30	Float [32b-LSW]	R	
43231	Line Current N InterHarmonic #31	Float [32b-LSW]	R	
43233	Line Current N InterHarmonic #32	Float [32b-LSW]	R	
43235	Line Current N InterHarmonic #33	Float [32b-LSW]	R	
43237	Line Current N InterHarmonic #34	Float [32b-LSW]	R	
43239	Line Current N InterHarmonic #35	Float [32b-LSW]	R	
43241	Line Current N InterHarmonic #36	Float [32b-LSW]	R	
43243	Line Current N InterHarmonic #37	Float [32b-LSW]	R	
43245	Line Current N InterHarmonic #38	Float [32b-LSW]	R	
43247	Line Current N InterHarmonic #39	Float [32b-LSW]	R	
43249	Line Current N InterHarmonic #40	Float [32b-LSW]	R	
43251	Line Current N InterHarmonic #41	Float [32b-LSW]	R	
43253	Line Current N InterHarmonic #42	Float [32b-LSW]	R	



Address Modbus	Description	Register Type	R/W	Default
43255	Line Current N InterHarmonic #43	Float [32b-LSW]	R	
43257	Line Current N InterHarmonic #44	Float [32b-LSW]	R	
43259	Line Current N InterHarmonic #45	Float [32b-LSW]	R	
43261	Line Current N InterHarmonic #46	Float [32b-LSW]	R	
43263	Line Current N InterHarmonic #47	Float [32b-LSW]	R	
43265	Line Current N InterHarmonic #48	Float [32b-LSW]	R	
43267	Line Current N InterHarmonic #49	Float [32b-LSW]	R	
43269	Line Current N InterHarmonic #50	Float [32b-LSW]	R	
43271	Line Current N InterHarmonic #51	Float [32b-LSW]	R	
43273	Line Current N InterHarmonic #52	Float [32b-LSW]	R	
43275	Line Current N InterHarmonic #53	Float [32b-LSW]	R	
43277	Line Current N InterHarmonic #54	Float [32b-LSW]	R	
43279	Line Current N InterHarmonic #55	Float [32b-LSW]	R	
43281	Line Current N InterHarmonic #56	Float [32b-LSW]	R	
43283	Line Current N InterHarmonic #57	Float [32b-LSW]	R	
43285	Line Current N InterHarmonic #58	Float [32b-LSW]	R	
43287	Line Current N InterHarmonic #59	Float [32b-LSW]	R	
43289	Line Current N InterHarmonic #60	Float [32b-LSW]	R	
43291	Line Current N InterHarmonic #61	Float [32b-LSW]	R	
43293	Line Current N InterHarmonic #62	Float [32b-LSW]	R	
43295	Line Current N InterHarmonic #63	Float [32b-LSW]	R	
43297	Voltage Sag RMS Value (between 10% and 90% of nominal star voltage (reg. 40045)) @ n-0	Float [32b-LSW]	R	
43299	Voltage Sag Year @ n-0	UShort [16b]	R	
43300	Voltage Sag Month @ n-0	UShort [16b]	R	
43301	Voltage Sag Day @ n-0	UShort [16b]	R	
43302	Voltage Sag Hour @ n-0	UShort [16b]	R	
43303	Voltage Sag Minute @ n-0	UShort [16b]	R	
43304	Voltage Sag Second @ n-0	UShort [16b]	R	
43305	Voltage Sag Duration [ms] @ n-0	UShort [16b]	R	
43306	Voltage Sag Type: 0 = ND 1 = V_L1N 2 = V_L2N 3 = V_L3N 4 = V_L1L2 5 = V_L2L3 6 = V_L3L1	UShort [16b]	R	
43307	Voltage Sag RMS Value (between 10% and 90% of nominal star voltage (reg. 40045)) @ n-1	Float [32b-LSW]	R	
43309	Voltage Sag Year @ n-1	UShort [16b]	R	
43310	Voltage Sag Month @ n-1	UShort [16b]	R	
43311	Voltage Sag Day @ n-1	UShort [16b]	R	
43312	Voltage Sag Hour @ n-1	UShort [16b]	R	
43313	Voltage Sag Minute @ n-1	UShort [16b]	R	
43314	Voltage Sag Second @ n-1	UShort [16b]	R	
43315	Voltage Sag Duration [ms] @ n-1	UShort [16b]	R	
43316	Voltage Sag Type: 0 = ND 1 = V_L1N 2 = V_L2N 3 = V_L3N 4 = V_L1L2 5 = V_L2L3 6 = V_L3L1	UShort [16b]	R	
43317	Voltage Sag RMS Value (between 10% and 90% of nominal star voltage (reg. 40045)) @ n-2	Float [32b-LSW]	R	
43319	Voltage Sag Year @ n-2	UShort [16b]	R	
43320	Voltage Sag Month @ n-2	UShort [16b]	R	
43321	Voltage Sag Day @ n-2	UShort [16b]	R	
43322	Voltage Sag Hour @ n-2	UShort [16b]	R	
43323	Voltage Sag Minute @ n-2	UShort [16b]	R	
43324	Voltage Sag Second @ n-2	UShort [16b]	R	
43325	Voltage Sag Duration [ms] @ n-2	UShort [16b]	R	



Address Modbus	Description	Register Type	R/W	Default
43326	Voltage Sag Type: 0 = ND 1 = V_L1N 2 = V_L2N 3 = V_L3N 4 = V_L1L2 5 = V_L2L3 6 = V_L3L1	UShort [16b]	R	
43327	Voltage Sag RMS Value (between 10% and 90% of nominal star voltage (reg. 40045)) @ n-3	Float [32b-LSW]	R	
43329	Voltage Sag Year @ n-3	UShort [16b]	R	
43330	Voltage Sag Month @ n-3	UShort [16b]	R	
43331	Voltage Sag Day @ n-3	UShort [16b]	R	
43332	Voltage Sag Hour @ n-3	UShort [16b]	R	
43333	Voltage Sag Minute @ n-3	UShort [16b]	R	
43334	Voltage Sag Second @ n-3	UShort [16b]	R	
43335	Voltage Sag Duration [ms] @ n-3	UShort [16b]	R	
43336	Voltage Sag Type: 0 = ND 1 = V_L1N 2 = V_L2N 3 = V_L3N 4 = V_L1L2 5 = V_L2L3 6 = V_L3L1	UShort [16b]	R	
43337	Voltage Sag RMS Value (between 10% and 90% of nominal star voltage (reg. 40045)) @ n-4	Float [32b-LSW]	R	
43339	Voltage Sag Year @ n-4	UShort [16b]	R	
43340	Voltage Sag Month @ n-4	UShort [16b]	R	
43341	Voltage Sag Day @ n-4	UShort [16b]	R	
43342	Voltage Sag Hour @ n-4	UShort [16b]	R	
43343	Voltage Sag Minute @ n-4	UShort [16b]	R	
43344	Voltage Sag Second @ n-4	UShort [16b]	R	
43345	Voltage Sag Duration [ms] @ n-4	UShort [16b]	R	
43346	Voltage Sag Type: 0 = ND 1 = V_L1N 2 = V_L2N 3 = V_L3N 4 = V_L1L2 5 = V_L2L3 6 = V_L3L1	UShort [16b]	R	
43347	Voltage Sag RMS Value (between 10% and 90% of nominal star voltage (reg. 40045)) @ n-5	Float [32b-LSW]	R	
43349	Voltage Sag Year @ n-5	UShort [16b]	R	
43350	Voltage Sag Month @ n-5	UShort [16b]	R	
43351	Voltage Sag Day @ n-5	UShort [16b]	R	
43352	Voltage Sag Hour @ n-5	UShort [16b]	R	
43353	Voltage Sag Minute @ n-5	UShort [16b]	R	
43354	Voltage Sag Second @ n-5	UShort [16b]	R	
43355	Voltage Sag Duration [ms] @ n-5	UShort [16b]	R	
43356	Voltage Sag Type: 0 = ND 1 = V_L1N 2 = V_L2N 3 = V_L3N 4 = V_L1L2 5 = V_L2L3 6 = V_L3L1	UShort [16b]	R	
43357	Voltage Sag RMS Value (between 10% and 90% of nominal star voltage (reg. 40045)) @ n-6	Float [32b-LSW]	R	
43359	Voltage Sag Year @ n-6	UShort [16b]	R	
43360	Voltage Sag Month @ n-6	UShort [16b]	R	
43361	Voltage Sag Day @ n-6	UShort [16b]	R	
43362	Voltage Sag Hour @ n-6	UShort [16b]	R	
43363	Voltage Sag Minute @ n-6	UShort [16b]	R	
43364	Voltage Sag Second @ n-6	UShort [16b]	R	
43365	Voltage Sag Duration [ms] @ n-6	UShort [16b]	R	



Address Modbus	Description	Register Type	R/W	Default
43366	Voltage Sag Type: 0 = ND 1 = V_L1N 2 = V_L2N 3 = V_L3N 4 = V_L1L2 5 = V_L2L3 6 = V_L3L1	UShort [16b]	R	
43367	Voltage Sag RMS Value (between 10% and 90% of nominal star voltage (reg. 40045)) @ n-7	Float [32b-LSW]	R	
43369	Voltage Sag Year @ n-7	UShort [16b]	R	
43370	Voltage Sag Month @ n-7	UShort [16b]	R	
43371	Voltage Sag Day @ n-7	UShort [16b]	R	
43372	Voltage Sag Hour @ n-7	UShort [16b]	R	
43373	Voltage Sag Minute @ n-7	UShort [16b]	R	
43374	Voltage Sag Second @ n-7	UShort [16b]	R	
43375	Voltage Sag Duration [ms] @ n-7	UShort [16b]	R	
43376	Voltage Sag Type: 0 = ND 1 = V_L1N 2 = V_L2N 3 = V_L3N 4 = V_L1L2 5 = V_L2L3 6 = V_L3L1	UShort [16b]	R	
43377	Voltage Sag RMS Value (between 10% and 90% of nominal star voltage (reg. 40045)) @ n-8	Float [32b-LSW]	R	
43379	Voltage Sag Year @ n-8	UShort [16b]	R	
43380	Voltage Sag Month @ n-8	UShort [16b]	R	
43381	Voltage Sag Day @ n-8	UShort [16b]	R	
43382	Voltage Sag Hour @ n-8	UShort [16b]	R	
43383	Voltage Sag Minute @ n-8	UShort [16b]	R	
43384	Voltage Sag Second @ n-8	UShort [16b]	R	
43385	Voltage Sag Duration [ms] @ n-8	UShort [16b]	R	
43386	Voltage Sag Type: 0 = ND 1 = V_L1N 2 = V_L2N 3 = V_L3N 4 = V_L1L2 5 = V_L2L3 6 = V_L3L1	UShort [16b]	R	
43387	Voltage Sag RMS Value (between 10% and 90% of nominal star voltage (reg. 40045)) @ n-9	Float [32b-LSW]	R	
43389	Voltage Sag Year @ n-9	UShort [16b]	R	
43390	Voltage Sag Month @ n-9	UShort [16b]	R	
43391	Voltage Sag Day @ n-9	UShort [16b]	R	
43392	Voltage Sag Hour @ n-9	UShort [16b]	R	
43393	Voltage Sag Minute @ n-9	UShort [16b]	R	
43394	Voltage Sag Second @ n-9	UShort [16b]	R	
43395	Voltage Sag Duration [ms] @ n-9	UShort [16b]	R	
43396	Voltage Sag Type: 0 = ND 1 = V_L1N 2 = V_L2N 3 = V_L3N 4 = V_L1L2 5 = V_L2L3 6 = V_L3L1	UShort [16b]	R	
43397	Voltage Sag RMS Value (between 10% and 90% of nominal star voltage (reg. 40045)) EEPROM data	Float [32b-LSW]	R	0
43399	Voltage Sag Year EEPROM data	UShort [16b]	R	
43400	Voltage Sag Month EEPROM data	UShort [16b]	R	
43401	Voltage Sag Day EEPROM data	UShort [16b]	R	
43402	Voltage Sag Hour EEPROM data	UShort [16b]	R	
43403	Voltage Sag Minute EEPROM data	UShort [16b]	R	
43404	Voltage Sag Second EEPROM data	UShort [16b]	R	
43405	Voltage Sag Duration [ms] EEPROM data	UShort [16b]	R	



Address Modbus	Description	Register Type	R/W	Default
43406	Voltage Sag Type: 0 = ND 1 = V_L1N 2 = V_L2N 3 = V_L3N 4 = V_L1L2 5 = V_L2L3 6 = V_L3L1	UShort [16b]	R	
43407	Voltage Swell RMS Value (between 10% and 90% of nominal star voltage (reg. 40045)) @ n-0	Float [32b-LSW]	R	
43409	Voltage Swell Year @ n-0	UShort [16b]	R	
43410	Voltage Swell Month @ n-0	UShort [16b]	R	
43411	Voltage Swell Day @ n-0	UShort [16b]	R	
43412	Voltage Swell Hour @ n-0	UShort [16b]	R	
43413	Voltage Swell Minute @ n-0	UShort [16b]	R	
43414	Voltage Swell Second @ n-0	UShort [16b]	R	
43415	Voltage Swell Duration [ms] @ n-0	UShort [16b]	R	
43416	Voltage Swell Type: 0 = ND 1 = V_L1N 2 = V_L2N 3 = V_L3N 4 = V_L1L2 5 = V_L2L3 6 = V_L3L1	UShort [16b]	R	
43417	Voltage Swell RMS Value (between 10% and 90% of nominal star voltage (reg. 40045)) @ n-1	Float [32b-LSW]	R	
43419	Voltage Swell Year @ n-1	UShort [16b]	R	
43420	Voltage Swell Month @ n-1	UShort [16b]	R	
43421	Voltage Swell Day @ n-1	UShort [16b]	R	
43422	Voltage Swell Hour @ n-1	UShort [16b]	R	
43423	Voltage Swell Minute @ n-1	UShort [16b]	R	
43424	Voltage Swell Second @ n-1	UShort [16b]	R	
43425	Voltage Swell Duration [ms] @ n-1	UShort [16b]	R	
43426	Voltage Swell Type: 0 = ND 1 = V_L1N 2 = V_L2N 3 = V_L3N 4 = V_L1L2 5 = V_L2L3 6 = V_L3L1	UShort [16b]	R	
43427	Voltage Swell RMS Value (between 10% and 90% of nominal star voltage (reg. 40045)) @ n-2	Float [32b-LSW]	R	
43429	Voltage Swell Year @ n-2	UShort [16b]	R	
43430	Voltage Swell Month @ n-2	UShort [16b]	R	
43431	Voltage Swell Day @ n-2	UShort [16b]	R	
43432	Voltage Swell Hour @ n-2	UShort [16b]	R	
43433	Voltage Swell Minute @ n-2	UShort [16b]	R	
43434	Voltage Swell Second @ n-2	UShort [16b]	R	
43435	Voltage Swell Duration [ms] @ n-2	UShort [16b]	R	
43436	Voltage Swell Type: 0 = ND 1 = V_L1N 2 = V_L2N 3 = V_L3N 4 = V_L1L2 5 = V_L2L3 6 = V_L3L1	UShort [16b]	R	
43437	Voltage Swell RMS Value (between 10% and 90% of nominal star voltage (reg. 40045)) @ n-3	Float [32b-LSW]	R	
43439	Voltage Swell Year @ n-3	UShort [16b]	R	
43440	Voltage Swell Month @ n-3	UShort [16b]	R	
43441	Voltage Swell Day @ n-3	UShort [16b]	R	
43442	Voltage Swell Hour @ n-3	UShort [16b]	R	
43443	Voltage Swell Minute @ n-3	UShort [16b]	R	
43444	Voltage Swell Second @ n-3	UShort [16b]	R	
43445	Voltage Swell Duration [ms] @ n-3	UShort [16b]	R	



Address Modbus	Description	Register Type	R/W	Default
43446	Voltage Swell Type: 0 = ND 1 = V_L1N 2 = V_L2N 3 = V_L3N 4 = V_L1L2 5 = V_L2L3 6 = V_L3L1	UShort [16b]	R	
43447	Voltage Swell RMS Value (between 10% and 90% of nominal star voltage (reg. 40045)) @ n-4	Float [32b-LSW]	R	
43449	Voltage Swell Year @ n-4	UShort [16b]	R	
43450	Voltage Swell Month @ n-4	UShort [16b]	R	
43451	Voltage Swell Day @ n-4	UShort [16b]	R	
43452	Voltage Swell Hour @ n-4	UShort [16b]	R	
43453	Voltage Swell Minute @ n-4	UShort [16b]	R	
43454	Voltage Swell Second @ n-4	UShort [16b]	R	
43455	Voltage Swell Duration [ms] @ n-4	UShort [16b]	R	
43456	Voltage Swell Type: 0 = ND 1 = V_L1N 2 = V_L2N 3 = V_L3N 4 = V_L1L2 5 = V_L2L3 6 = V_L3L1	UShort [16b]	R	
43457	Voltage Swell RMS Value (between 10% and 90% of nominal star voltage (reg. 40045)) @ n-5	Float [32b-LSW]	R	
43459	Voltage Swell Year @ n-5	UShort [16b]	R	
43460	Voltage Swell Month @ n-5	UShort [16b]	R	
43461	Voltage Swell Day @ n-5	UShort [16b]	R	
43462	Voltage Swell Hour @ n-5	UShort [16b]	R	
43463	Voltage Swell Minute @ n-5	UShort [16b]	R	
43464	Voltage Swell Second @ n-5	UShort [16b]	R	
43465	Voltage Swell Duration [ms] @ n-5	UShort [16b]	R	
43466	Voltage Swell Type: 0 = ND 1 = V_L1N 2 = V_L2N 3 = V_L3N 4 = V_L1L2 5 = V_L2L3 6 = V_L3L1	UShort [16b]	R	
43467	Voltage Swell RMS Value (between 10% and 90% of nominal star voltage (reg. 40045)) @ n-6	Float [32b-LSW]	R	
43469	Voltage Swell Year @ n-6	UShort [16b]	R	
43470	Voltage Swell Month @ n-6	UShort [16b]	R	
43471	Voltage Swell Day @ n-6	UShort [16b]	R	
43472	Voltage Swell Hour @ n-6	UShort [16b]	R	
43473	Voltage Swell Minute @ n-6	UShort [16b]	R	
43474	Voltage Swell Second @ n-6	UShort [16b]	R	
43475	Voltage Swell Duration [ms] @ n-6	UShort [16b]	R	
43476	Voltage Swell Type: 0 = ND 1 = V_L1N 2 = V_L2N 3 = V_L3N 4 = V_L1L2 5 = V_L2L3 6 = V_L3L1	UShort [16b]	R	
43477	Voltage Swell RMS Value (between 10% and 90% of nominal star voltage (reg. 40045)) @ n-7	Float [32b-LSW]	R	
43479	Voltage Swell Year @ n-7	UShort [16b]	R	
43480	Voltage Swell Month @ n-7	UShort [16b]	R	
43481	Voltage Swell Day @ n-7	UShort [16b]	R	
43482	Voltage Swell Hour @ n-7	UShort [16b]	R	
43483	Voltage Swell Minute @ n-7	UShort [16b]	R	
43484	Voltage Swell Second @ n-7	UShort [16b]	R	
43485	Voltage Swell Duration [ms] @ n-7	UShort [16b]	R	



Address Modbus	Description	Register Type	R/W	Default
43486	Voltage Swell Type: 0 = ND 1 = V_L1N 2 = V_L2N 3 = V_L3N 4 = V_L1L2 5 = V_L2L3 6 = V_L3L1	UShort [16b]	R	
43487	Voltage Swell RMS Value (between 10% and 90% of nominal star voltage (reg. 40045)) @ n-8	Float [32b-LSW]	R	
43489	Voltage Swell Year @ n-8	UShort [16b]	R	
43490	Voltage Swell Month @ n-8	UShort [16b]	R	
43491	Voltage Swell Day @ n-8	UShort [16b]	R	
43492	Voltage Swell Hour @ n-8	UShort [16b]	R	
43493	Voltage Swell Minute @ n-8	UShort [16b]	R	
43494	Voltage Swell Second @ n-8	UShort [16b]	R	
43495	Voltage Swell Duration [ms] @ n-8	UShort [16b]	R	
43496	Voltage Swell Type: 0 = ND 1 = V_L1N 2 = V_L2N 3 = V_L3N 4 = V_L1L2 5 = V_L2L3 6 = V_L3L1	UShort [16b]	R	
43497	Voltage Swell RMS Value (between 10% and 90% of nominal star voltage (reg. 40045)) @ n-9	Float [32b-LSW]	R	
43499	Voltage Swell Year @ n-9	UShort [16b]	R	
43500	Voltage Swell Month @ n-9	UShort [16b]	R	
43501	Voltage Swell Day @ n-9	UShort [16b]	R	
43502	Voltage Swell Hour @ n-9	UShort [16b]	R	
43503	Voltage Swell Minute @ n-9	UShort [16b]	R	
43504	Voltage Swell Second @ n-9	UShort [16b]	R	
43505	Voltage Swell Duration [ms] @ n-9	UShort [16b]	R	
43506	Voltage Swell Type: 0 = ND 1 = V_L1N 2 = V_L2N 3 = V_L3N 4 = V_L1L2 5 = V_L2L3 6 = V_L3L1	UShort [16b]	R	
43507	Voltage Swell RMS Value (between 10% and 90% of nominal star voltage (reg. 40045)) EEPROM data	Float [32b-LSW]	R	0
43509	Voltage Swell Year EEPROM data	UShort [16b]	R	
43510	Voltage Swell Month EEPROM data	UShort [16b]	R	
43511	Voltage Swell Day EEPROM data	UShort [16b]	R	
43512	Voltage Swell Hour EEPROM data	UShort [16b]	R	
43513	Voltage Swell Minute EEPROM data	UShort [16b]	R	
43514	Voltage Swell Second EEPROM data	UShort [16b]	R	
43515	Voltage Swell Duration [ms] EEPROM data	UShort [16b]	R	
43516	Voltage Swell Type: 0 = ND 1 = V_L1N 2 = V_L2N 3 = V_L3N 4 = V_L1L2 5 = V_L2L3 6 = V_L3L1	UShort [16b]	R	
43517	Voltage Interruption RMS Value (between 10% and 90% of nominal star voltage (reg. 40045)) @ n-0	Float [32b-LSW]	R	
43519	Voltage Interruption Year @ n-0	UShort [16b]	R	
43520	Voltage Interruption Month @ n-0	UShort [16b]	R	
43521	Voltage Interruption Day @ n-0	UShort [16b]	R	
43522	Voltage Interruption Hour @ n-0	UShort [16b]	R	
43523	Voltage Interruption Minute @ n-0	UShort [16b]	R	
43524	Voltage Interruption Second @ n-0	UShort [16b]	R	
43525	Voltage Interruption Duration [ms] @ n-0	UShort [16b]	R	



Address Modbus	Description	Register Type	R/W	Default
43526	Voltage Interruption Type: 0 = ND 1 = V_L1N 2 = V_L2N 3 = V_L3N 4 = V_L1L2 5 = V_L2L3 6 = V_L3L1	UShort [16b]	R	
43527	Voltage Interruption RMS Value (between 10% and 90% of nominal star voltage (reg. 40045)) @ n-1	Float [32b-LSW]	R	
43529	Voltage Interruption Year @ n-1	UShort [16b]	R	
43530	Voltage Interruption Month @ n-1	UShort [16b]	R	
43531	Voltage Interruption Day @ n-1	UShort [16b]	R	
43532	Voltage Interruption Hour @ n-1	UShort [16b]	R	
43533	Voltage Interruption Minute @ n-1	UShort [16b]	R	
43534	Voltage Interruption Second @ n-1	UShort [16b]	R	
43535	Voltage Interruption Duration [ms] @ n-1	UShort [16b]	R	
43536	Voltage Interruption Type: 0 = ND 1 = V_L1N 2 = V_L2N 3 = V_L3N 4 = V_L1L2 5 = V_L2L3 6 = V_L3L1	UShort [16b]	R	
43537	Voltage Interruption RMS Value (between 10% and 90% of nominal star voltage (reg. 40045)) @ n-2	Float [32b-LSW]	R	
43539	Voltage Interruption Year @ n-2	UShort [16b]	R	
43540	Voltage Interruption Month @ n-2	UShort [16b]	R	
43541	Voltage Interruption Day @ n-2	UShort [16b]	R	
43542	Voltage Interruption Hour @ n-2	UShort [16b]	R	
43543	Voltage Interruption Minute @ n-2	UShort [16b]	R	
43544	Voltage Interruption Second @ n-2	UShort [16b]	R	
43545	Voltage Interruption Duration [ms] @ n-2	UShort [16b]	R	
43546	Voltage Interruption Type: 0 = ND 1 = V_L1N 2 = V_L2N 3 = V_L3N 4 = V_L1L2 5 = V_L2L3 6 = V_L3L1	UShort [16b]	R	
43547	Voltage Interruption RMS Value (between 10% and 90% of nominal star voltage (reg. 40045)) @ n-3	Float [32b-LSW]	R	
43549	Voltage Interruption Year @ n-3	UShort [16b]	R	
43550	Voltage Interruption Month @ n-3	UShort [16b]	R	
43551	Voltage Interruption Day @ n-3	UShort [16b]	R	
43552	Voltage Interruption Hour @ n-3	UShort [16b]	R	
43553	Voltage Interruption Minute @ n-3	UShort [16b]	R	
43554	Voltage Interruption Second @ n-3	UShort [16b]	R	
43555	Voltage Interruption Duration [ms] @ n-3	UShort [16b]	R	
43556	Voltage Interruption Type: 0 = ND 1 = V_L1N 2 = V_L2N 3 = V_L3N 4 = V_L1L2 5 = V_L2L3 6 = V_L3L1	UShort [16b]	R	
43557	Voltage Interruption RMS Value (between 10% and 90% of nominal star voltage (reg. 40045)) @ n-4	Float [32b-LSW]	R	
43559	Voltage Interruption Year @ n-4	UShort [16b]	R	
43560	Voltage Interruption Month @ n-4	UShort [16b]	R	
43561	Voltage Interruption Day @ n-4	UShort [16b]	R	
43562	Voltage Interruption Hour @ n-4	UShort [16b]	R	
43563	Voltage Interruption Minute @ n-4	UShort [16b]	R	
43564	Voltage Interruption Second @ n-4	UShort [16b]	R	
43565	Voltage Interruption Duration [ms] @ n-4	UShort [16b]	R	



Address Modbus	Description	Register Type	R/W	Default
43566	Voltage Interruption Type: 0 = ND 1 = V_L1N 2 = V_L2N 3 = V_L3N 4 = V_L1L2 5 = V_L2L3 6 = V_L3L1	UShort [16b]	R	
43567	Voltage Interruption RMS Value (between 10% and 90% of nominal star voltage (reg. 40045)) @ n-5	Float [32b-LSW]	R	
43569	Voltage Interruption Year @ n-5	UShort [16b]	R	
43570	Voltage Interruption Month @ n-5	UShort [16b]	R	
43571	Voltage Interruption Day @ n-5	UShort [16b]	R	
43572	Voltage Interruption Hour @ n-5	UShort [16b]	R	
43573	Voltage Interruption Minute @ n-5	UShort [16b]	R	
43574	Voltage Interruption Second @ n-5	UShort [16b]	R	
43575	Voltage Interruption Duration [ms] @ n-5	UShort [16b]	R	
43576	Voltage Interruption Type: 0 = ND 1 = V_L1N 2 = V_L2N 3 = V_L3N 4 = V_L1L2 5 = V_L2L3 6 = V_L3L1	UShort [16b]	R	
43577	Voltage Interruption RMS Value (between 10% and 90% of nominal star voltage (reg. 40045)) @ n-6	Float [32b-LSW]	R	
43579	Voltage Interruption Year @ n-6	UShort [16b]	R	
43580	Voltage Interruption Month @ n-6	UShort [16b]	R	
43581	Voltage Interruption Day @ n-6	UShort [16b]	R	
43582	Voltage Interruption Hour @ n-6	UShort [16b]	R	
43583	Voltage Interruption Minute @ n-6	UShort [16b]	R	
43584	Voltage Interruption Second @ n-6	UShort [16b]	R	
43585	Voltage Interruption Duration [ms] @ n-6	UShort [16b]	R	
43586	Voltage Interruption Type: 0 = ND 1 = V_L1N 2 = V_L2N 3 = V_L3N 4 = V_L1L2 5 = V_L2L3 6 = V_L3L1	UShort [16b]	R	
43587	Voltage Interruption RMS Value (between 10% and 90% of nominal star voltage (reg. 40045)) @ n-7	Float [32b-LSW]	R	
43589	Voltage Interruption Year @ n-7	UShort [16b]	R	
43590	Voltage Interruption Month @ n-7	UShort [16b]	R	
43591	Voltage Interruption Day @ n-7	UShort [16b]	R	
43592	Voltage Interruption Hour @ n-7	UShort [16b]	R	
43593	Voltage Interruption Minute @ n-7	UShort [16b]	R	
43594	Voltage Interruption Second @ n-7	UShort [16b]	R	
43595	Voltage Interruption Duration [ms] @ n-7	UShort [16b]	R	
43596	Voltage Interruption Type: 0 = ND 1 = V_L1N 2 = V_L2N 3 = V_L3N 4 = V_L1L2 5 = V_L2L3 6 = V_L3L1	UShort [16b]	R	
43597	Voltage Interruption RMS Value (between 10% and 90% of nominal star voltage (reg. 40045)) @ n-8	Float [32b-LSW]	R	
43599	Voltage Interruption Year @ n-8	UShort [16b]	R	
43600	Voltage Interruption Month @ n-8	UShort [16b]	R	
43601	Voltage Interruption Day @ n-8	UShort [16b]	R	
43602	Voltage Interruption Hour @ n-8	UShort [16b]	R	
43603	Voltage Interruption Minute @ n-8	UShort [16b]	R	
43604	Voltage Interruption Second @ n-8	UShort [16b]	R	
43605	Voltage Interruption Duration [ms] @ n-8	UShort [16b]	R	



Address Modbus	Description	Register Type	R/W	Default
43606	Voltage Interruption Type: 0 = ND 1 = V_L1N 2 = V_L2N 3 = V_L3N 4 = V_L1L2 5 = V_L2L3 6 = V_L3L1	UShort [16b]	R	
43607	Voltage Interruption RMS Value (between 10% and 90% of nominal star voltage (reg. 40045)) @ n-9	Float [32b-LSW]	R	
43609	Voltage Interruption Year @ n-9	UShort [16b]	R	
43610	Voltage Interruption Month @ n-9	UShort [16b]	R	
43611	Voltage Interruption Day @ n-9	UShort [16b]	R	
43612	Voltage Interruption Hour @ n-9	UShort [16b]	R	
43613	Voltage Interruption Minute @ n-9	UShort [16b]	R	
43614	Voltage Interruption Second @ n-9	UShort [16b]	R	
43615	Voltage Interruption Duration [ms] @ n-9	UShort [16b]	R	
43616	Voltage Interruption Type: 0 = ND 1 = V_L1N 2 = V_L2N 3 = V_L3N 4 = V_L1L2 5 = V_L2L3 6 = V_L3L1	UShort [16b]	R	
43617	Voltage Interruption RMS Value (between 10% and 90% of nominal star voltage (reg. 40045)) EEPROM data	Float [32b-LSW]	R	0
43619	Voltage Interruption Year EEPROM data	UShort [16b]	R	
43620	Voltage Interruption Month EEPROM data	UShort [16b]	R	
43621	Voltage Interruption Day EEPROM data	UShort [16b]	R	
43622	Voltage Interruption Hour EEPROM data	UShort [16b]	R	
43623	Voltage Interruption Minute EEPROM data	UShort [16b]	R	
43624	Voltage Interruption Second EEPROM data	UShort [16b]	R	
43625	Voltage Interruption Duration [ms] EEPROM data	UShort [16b]	R	
43626	Voltage Interruption Type: 0 = ND 1 = V_L1N 2 = V_L2N 3 = V_L3N 4 = V_L1L2 5 = V_L2L3 6 = V_L3L1	UShort [16b]	R	
43627	Star Voltage L1-N Sample #0	Float [32b-LSW]	R	
43629	Star Voltage L1-N Sample #1	Float [32b-LSW]	R	
43631	Star Voltage L1-N Sample #2	Float [32b-LSW]	R	
43633	Star Voltage L1-N Sample #3	Float [32b-LSW]	R	
43635	Star Voltage L1-N Sample #4	Float [32b-LSW]	R	
43637	Star Voltage L1-N Sample #5	Float [32b-LSW]	R	
43639	Star Voltage L1-N Sample #6	Float [32b-LSW]	R	
43641	Star Voltage L1-N Sample #7	Float [32b-LSW]	R	
43643	Star Voltage L1-N Sample #8	Float [32b-LSW]	R	
43645	Star Voltage L1-N Sample #9	Float [32b-LSW]	R	
43647	Star Voltage L1-N Sample #10	Float [32b-LSW]	R	
43649	Star Voltage L1-N Sample #11	Float [32b-LSW]	R	
43651	Star Voltage L1-N Sample #12	Float [32b-LSW]	R	
43653	Star Voltage L1-N Sample #13	Float [32b-LSW]	R	
43655	Star Voltage L1-N Sample #14	Float [32b-LSW]	R	
43657	Star Voltage L1-N Sample #15	Float [32b-LSW]	R	
43659	Star Voltage L1-N Sample #16	Float [32b-LSW]	R	
43661	Star Voltage L1-N Sample #17	Float [32b-LSW]	R	
43663	Star Voltage L1-N Sample #18	Float [32b-LSW]	R	
43665	Star Voltage L1-N Sample #19	Float [32b-LSW]	R	
43667	Star Voltage L1-N Sample #20	Float [32b-LSW]	R	
43669	Star Voltage L1-N Sample #21	Float [32b-LSW]	R	
43671	Star Voltage L1-N Sample #22	Float [32b-LSW]	R	
43673	Star Voltage L1-N Sample #23	Float [32b-LSW]	R	
43675	Star Voltage L1-N Sample #24	Float [32b-LSW]	R	
43677	Star Voltage L1-N Sample #25	Float [32b-LSW]	R	



Address Modbus	Description	Register Type	R/W	Default
43679	Star Voltage L1-N Sample #26	Float [32b-LSW]	R	
43681	Star Voltage L1-N Sample #27	Float [32b-LSW]	R	
43683	Star Voltage L1-N Sample #28	Float [32b-LSW]	R	
43685	Star Voltage L1-N Sample #29	Float [32b-LSW]	R	
43687	Star Voltage L1-N Sample #30	Float [32b-LSW]	R	
43689	Star Voltage L1-N Sample #31	Float [32b-LSW]	R	
43691	Star Voltage L1-N Sample #32	Float [32b-LSW]	R	
43693	Star Voltage L1-N Sample #33	Float [32b-LSW]	R	
43695	Star Voltage L1-N Sample #34	Float [32b-LSW]	R	
43697	Star Voltage L1-N Sample #35	Float [32b-LSW]	R	
43699	Star Voltage L1-N Sample #36	Float [32b-LSW]	R	
43701	Star Voltage L1-N Sample #37	Float [32b-LSW]	R	
43703	Star Voltage L1-N Sample #38	Float [32b-LSW]	R	
43705	Star Voltage L1-N Sample #39	Float [32b-LSW]	R	
43707	Star Voltage L1-N Sample #40	Float [32b-LSW]	R	
43709	Star Voltage L1-N Sample #41	Float [32b-LSW]	R	
43711	Star Voltage L1-N Sample #42	Float [32b-LSW]	R	
43713	Star Voltage L1-N Sample #43	Float [32b-LSW]	R	
43715	Star Voltage L1-N Sample #44	Float [32b-LSW]	R	
43717	Star Voltage L1-N Sample #45	Float [32b-LSW]	R	
43719	Star Voltage L1-N Sample #46	Float [32b-LSW]	R	
43721	Star Voltage L1-N Sample #47	Float [32b-LSW]	R	
43723	Star Voltage L1-N Sample #48	Float [32b-LSW]	R	
43725	Star Voltage L1-N Sample #49	Float [32b-LSW]	R	
43727	Star Voltage L1-N Sample #50	Float [32b-LSW]	R	
43729	Star Voltage L1-N Sample #51	Float [32b-LSW]	R	
43731	Star Voltage L1-N Sample #52	Float [32b-LSW]	R	
43733	Star Voltage L1-N Sample #53	Float [32b-LSW]	R	
43735	Star Voltage L1-N Sample #54	Float [32b-LSW]	R	
43737	Star Voltage L1-N Sample #55	Float [32b-LSW]	R	
43739	Star Voltage L1-N Sample #56	Float [32b-LSW]	R	
43741	Star Voltage L1-N Sample #57	Float [32b-LSW]	R	
43743	Star Voltage L1-N Sample #58	Float [32b-LSW]	R	
43745	Star Voltage L1-N Sample #59	Float [32b-LSW]	R	
43747	Star Voltage L1-N Sample #60	Float [32b-LSW]	R	
43749	Star Voltage L1-N Sample #61	Float [32b-LSW]	R	
43751	Star Voltage L1-N Sample #62	Float [32b-LSW]	R	
43753	Star Voltage L1-N Sample #63	Float [32b-LSW]	R	
43755	Star Voltage L1-N Sample #64	Float [32b-LSW]	R	
43757	Star Voltage L1-N Sample #65	Float [32b-LSW]	R	
43759	Star Voltage L1-N Sample #66	Float [32b-LSW]	R	
43761	Star Voltage L1-N Sample #67	Float [32b-LSW]	R	
43763	Star Voltage L1-N Sample #68	Float [32b-LSW]	R	
43765	Star Voltage L1-N Sample #69	Float [32b-LSW]	R	
43767	Star Voltage L1-N Sample #70	Float [32b-LSW]	R	
43769	Star Voltage L1-N Sample #71	Float [32b-LSW]	R	
43771	Star Voltage L1-N Sample #72	Float [32b-LSW]	R	
43773	Star Voltage L1-N Sample #73	Float [32b-LSW]	R	
43775	Star Voltage L1-N Sample #74	Float [32b-LSW]	R	
43777	Star Voltage L1-N Sample #75	Float [32b-LSW]	R	
43779	Star Voltage L1-N Sample #76	Float [32b-LSW]	R	
43781	Star Voltage L1-N Sample #77	Float [32b-LSW]	R	
43783	Star Voltage L1-N Sample #78	Float [32b-LSW]	R	
43785	Star Voltage L1-N Sample #79	Float [32b-LSW]	R	
43787	Star Voltage L1-N Sample #80	Float [32b-LSW]	R	
43789	Star Voltage L1-N Sample #81	Float [32b-LSW]	R	
43791	Star Voltage L1-N Sample #82	Float [32b-LSW]	R	
43793	Star Voltage L1-N Sample #83	Float [32b-LSW]	R	
43795	Star Voltage L1-N Sample #84	Float [32b-LSW]	R	
43797	Star Voltage L1-N Sample #85	Float [32b-LSW]	R	
43799	Star Voltage L1-N Sample #86	Float [32b-LSW]	R	
43801	Star Voltage L1-N Sample #87	Float [32b-LSW]	R	



Address Modbus	Description	Register Type	R/W	Default
43803	Star Voltage L1-N Sample #88	Float [32b-LSW]	R	
43805	Star Voltage L1-N Sample #89	Float [32b-LSW]	R	
43807	Star Voltage L1-N Sample #90	Float [32b-LSW]	R	
43809	Star Voltage L1-N Sample #91	Float [32b-LSW]	R	
43811	Star Voltage L1-N Sample #92	Float [32b-LSW]	R	
43813	Star Voltage L1-N Sample #93	Float [32b-LSW]	R	
43815	Star Voltage L1-N Sample #94	Float [32b-LSW]	R	
43817	Star Voltage L1-N Sample #95	Float [32b-LSW]	R	
43819	Star Voltage L1-N Sample #96	Float [32b-LSW]	R	
43821	Star Voltage L1-N Sample #97	Float [32b-LSW]	R	
43823	Star Voltage L1-N Sample #98	Float [32b-LSW]	R	
43825	Star Voltage L1-N Sample #99	Float [32b-LSW]	R	
43827	Star Voltage L1-N Sample #100	Float [32b-LSW]	R	
43829	Star Voltage L1-N Sample #101	Float [32b-LSW]	R	
43831	Star Voltage L1-N Sample #102	Float [32b-LSW]	R	
43833	Star Voltage L1-N Sample #103	Float [32b-LSW]	R	
43835	Star Voltage L1-N Sample #104	Float [32b-LSW]	R	
43837	Star Voltage L1-N Sample #105	Float [32b-LSW]	R	
43839	Star Voltage L1-N Sample #106	Float [32b-LSW]	R	
43841	Star Voltage L1-N Sample #107	Float [32b-LSW]	R	
43843	Star Voltage L1-N Sample #108	Float [32b-LSW]	R	
43845	Star Voltage L1-N Sample #109	Float [32b-LSW]	R	
43847	Star Voltage L1-N Sample #110	Float [32b-LSW]	R	
43849	Star Voltage L1-N Sample #111	Float [32b-LSW]	R	
43851	Star Voltage L1-N Sample #112	Float [32b-LSW]	R	
43853	Star Voltage L1-N Sample #113	Float [32b-LSW]	R	
43855	Star Voltage L1-N Sample #114	Float [32b-LSW]	R	
43857	Star Voltage L1-N Sample #115	Float [32b-LSW]	R	
43859	Star Voltage L1-N Sample #116	Float [32b-LSW]	R	
43861	Star Voltage L1-N Sample #117	Float [32b-LSW]	R	
43863	Star Voltage L1-N Sample #118	Float [32b-LSW]	R	
43865	Star Voltage L1-N Sample #119	Float [32b-LSW]	R	
43867	Star Voltage L1-N Sample #120	Float [32b-LSW]	R	
43869	Star Voltage L1-N Sample #121	Float [32b-LSW]	R	
43871	Star Voltage L1-N Sample #122	Float [32b-LSW]	R	
43873	Star Voltage L1-N Sample #123	Float [32b-LSW]	R	
43875	Star Voltage L1-N Sample #124	Float [32b-LSW]	R	
43877	Star Voltage L1-N Sample #125	Float [32b-LSW]	R	
43879	Star Voltage L1-N Sample #126	Float [32b-LSW]	R	
43881	Star Voltage L1-N Sample #127	Float [32b-LSW]	R	
43883	Star Voltage L2-N Sample #0	Float [32b-LSW]	R	
43885	Star Voltage L2-N Sample #1	Float [32b-LSW]	R	
43887	Star Voltage L2-N Sample #2	Float [32b-LSW]	R	
43889	Star Voltage L2-N Sample #3	Float [32b-LSW]	R	
43891	Star Voltage L2-N Sample #4	Float [32b-LSW]	R	
43893	Star Voltage L2-N Sample #5	Float [32b-LSW]	R	
43895	Star Voltage L2-N Sample #6	Float [32b-LSW]	R	
43897	Star Voltage L2-N Sample #7	Float [32b-LSW]	R	
43899	Star Voltage L2-N Sample #8	Float [32b-LSW]	R	
43901	Star Voltage L2-N Sample #9	Float [32b-LSW]	R	
43903	Star Voltage L2-N Sample #10	Float [32b-LSW]	R	
43905	Star Voltage L2-N Sample #11	Float [32b-LSW]	R	
43907	Star Voltage L2-N Sample #12	Float [32b-LSW]	R	
43909	Star Voltage L2-N Sample #13	Float [32b-LSW]	R	
43911	Star Voltage L2-N Sample #14	Float [32b-LSW]	R	
43913	Star Voltage L2-N Sample #15	Float [32b-LSW]	R	
43915	Star Voltage L2-N Sample #16	Float [32b-LSW]	R	
43917	Star Voltage L2-N Sample #17	Float [32b-LSW]	R	
43919	Star Voltage L2-N Sample #18	Float [32b-LSW]	R	
43921	Star Voltage L2-N Sample #19	Float [32b-LSW]	R	
43923	Star Voltage L2-N Sample #20	Float [32b-LSW]	R	
43925	Star Voltage L2-N Sample #21	Float [32b-LSW]	R	



Address Modbus	Description	Register Type	R/W	Default
43927	Star Voltage L2-N Sample #22	Float [32b-LSW]	R	
43929	Star Voltage L2-N Sample #23	Float [32b-LSW]	R	
43931	Star Voltage L2-N Sample #24	Float [32b-LSW]	R	
43933	Star Voltage L2-N Sample #25	Float [32b-LSW]	R	
43935	Star Voltage L2-N Sample #26	Float [32b-LSW]	R	
43937	Star Voltage L2-N Sample #27	Float [32b-LSW]	R	
43939	Star Voltage L2-N Sample #28	Float [32b-LSW]	R	
43941	Star Voltage L2-N Sample #29	Float [32b-LSW]	R	
43943	Star Voltage L2-N Sample #30	Float [32b-LSW]	R	
43945	Star Voltage L2-N Sample #31	Float [32b-LSW]	R	
43947	Star Voltage L2-N Sample #32	Float [32b-LSW]	R	
43949	Star Voltage L2-N Sample #33	Float [32b-LSW]	R	
43951	Star Voltage L2-N Sample #34	Float [32b-LSW]	R	
43953	Star Voltage L2-N Sample #35	Float [32b-LSW]	R	
43955	Star Voltage L2-N Sample #36	Float [32b-LSW]	R	
43957	Star Voltage L2-N Sample #37	Float [32b-LSW]	R	
43959	Star Voltage L2-N Sample #38	Float [32b-LSW]	R	
43961	Star Voltage L2-N Sample #39	Float [32b-LSW]	R	
43963	Star Voltage L2-N Sample #40	Float [32b-LSW]	R	
43965	Star Voltage L2-N Sample #41	Float [32b-LSW]	R	
43967	Star Voltage L2-N Sample #42	Float [32b-LSW]	R	
43969	Star Voltage L2-N Sample #43	Float [32b-LSW]	R	
43971	Star Voltage L2-N Sample #44	Float [32b-LSW]	R	
43973	Star Voltage L2-N Sample #45	Float [32b-LSW]	R	
43975	Star Voltage L2-N Sample #46	Float [32b-LSW]	R	
43977	Star Voltage L2-N Sample #47	Float [32b-LSW]	R	
43979	Star Voltage L2-N Sample #48	Float [32b-LSW]	R	
43981	Star Voltage L2-N Sample #49	Float [32b-LSW]	R	
43983	Star Voltage L2-N Sample #50	Float [32b-LSW]	R	
43985	Star Voltage L2-N Sample #51	Float [32b-LSW]	R	
43987	Star Voltage L2-N Sample #52	Float [32b-LSW]	R	
43989	Star Voltage L2-N Sample #53	Float [32b-LSW]	R	
43991	Star Voltage L2-N Sample #54	Float [32b-LSW]	R	
43993	Star Voltage L2-N Sample #55	Float [32b-LSW]	R	
43995	Star Voltage L2-N Sample #56	Float [32b-LSW]	R	
43997	Star Voltage L2-N Sample #57	Float [32b-LSW]	R	
43999	Star Voltage L2-N Sample #58	Float [32b-LSW]	R	
44001	Star Voltage L2-N Sample #59	Float [32b-LSW]	R	
44003	Star Voltage L2-N Sample #60	Float [32b-LSW]	R	
44005	Star Voltage L2-N Sample #61	Float [32b-LSW]	R	
44007	Star Voltage L2-N Sample #62	Float [32b-LSW]	R	
44009	Star Voltage L2-N Sample #63	Float [32b-LSW]	R	
44011	Star Voltage L2-N Sample #64	Float [32b-LSW]	R	
44013	Star Voltage L2-N Sample #65	Float [32b-LSW]	R	
44015	Star Voltage L2-N Sample #66	Float [32b-LSW]	R	
44017	Star Voltage L2-N Sample #67	Float [32b-LSW]	R	
44019	Star Voltage L2-N Sample #68	Float [32b-LSW]	R	
44021	Star Voltage L2-N Sample #69	Float [32b-LSW]	R	
44023	Star Voltage L2-N Sample #70	Float [32b-LSW]	R	
44025	Star Voltage L2-N Sample #71	Float [32b-LSW]	R	
44027	Star Voltage L2-N Sample #72	Float [32b-LSW]	R	
44029	Star Voltage L2-N Sample #73	Float [32b-LSW]	R	
44031	Star Voltage L2-N Sample #74	Float [32b-LSW]	R	
44033	Star Voltage L2-N Sample #75	Float [32b-LSW]	R	
44035	Star Voltage L2-N Sample #76	Float [32b-LSW]	R	
44037	Star Voltage L2-N Sample #77	Float [32b-LSW]	R	
44039	Star Voltage L2-N Sample #78	Float [32b-LSW]	R	
44041	Star Voltage L2-N Sample #79	Float [32b-LSW]	R	
44043	Star Voltage L2-N Sample #80	Float [32b-LSW]	R	
44045	Star Voltage L2-N Sample #81	Float [32b-LSW]	R	
44047	Star Voltage L2-N Sample #82	Float [32b-LSW]	R	
44049	Star Voltage L2-N Sample #83	Float [32b-LSW]	R	



Address Modbus	Description	Register Type	R/W	Default
44051	Star Voltage L2-N Sample #84	Float [32b-LSW]	R	
44053	Star Voltage L2-N Sample #85	Float [32b-LSW]	R	
44055	Star Voltage L2-N Sample #86	Float [32b-LSW]	R	
44057	Star Voltage L2-N Sample #87	Float [32b-LSW]	R	
44059	Star Voltage L2-N Sample #88	Float [32b-LSW]	R	
44061	Star Voltage L2-N Sample #89	Float [32b-LSW]	R	
44063	Star Voltage L2-N Sample #90	Float [32b-LSW]	R	
44065	Star Voltage L2-N Sample #91	Float [32b-LSW]	R	
44067	Star Voltage L2-N Sample #92	Float [32b-LSW]	R	
44069	Star Voltage L2-N Sample #93	Float [32b-LSW]	R	
44071	Star Voltage L2-N Sample #94	Float [32b-LSW]	R	
44073	Star Voltage L2-N Sample #95	Float [32b-LSW]	R	
44075	Star Voltage L2-N Sample #96	Float [32b-LSW]	R	
44077	Star Voltage L2-N Sample #97	Float [32b-LSW]	R	
44079	Star Voltage L2-N Sample #98	Float [32b-LSW]	R	
44081	Star Voltage L2-N Sample #99	Float [32b-LSW]	R	
44083	Star Voltage L2-N Sample #100	Float [32b-LSW]	R	
44085	Star Voltage L2-N Sample #101	Float [32b-LSW]	R	
44087	Star Voltage L2-N Sample #102	Float [32b-LSW]	R	
44089	Star Voltage L2-N Sample #103	Float [32b-LSW]	R	
44091	Star Voltage L2-N Sample #104	Float [32b-LSW]	R	
44093	Star Voltage L2-N Sample #105	Float [32b-LSW]	R	
44095	Star Voltage L2-N Sample #106	Float [32b-LSW]	R	
44097	Star Voltage L2-N Sample #107	Float [32b-LSW]	R	
44099	Star Voltage L2-N Sample #108	Float [32b-LSW]	R	
44101	Star Voltage L2-N Sample #109	Float [32b-LSW]	R	
44103	Star Voltage L2-N Sample #110	Float [32b-LSW]	R	
44105	Star Voltage L2-N Sample #111	Float [32b-LSW]	R	
44107	Star Voltage L2-N Sample #112	Float [32b-LSW]	R	
44109	Star Voltage L2-N Sample #113	Float [32b-LSW]	R	
44111	Star Voltage L2-N Sample #114	Float [32b-LSW]	R	
44113	Star Voltage L2-N Sample #115	Float [32b-LSW]	R	
44115	Star Voltage L2-N Sample #116	Float [32b-LSW]	R	
44117	Star Voltage L2-N Sample #117	Float [32b-LSW]	R	
44119	Star Voltage L2-N Sample #118	Float [32b-LSW]	R	
44121	Star Voltage L2-N Sample #119	Float [32b-LSW]	R	
44123	Star Voltage L2-N Sample #120	Float [32b-LSW]	R	
44125	Star Voltage L2-N Sample #121	Float [32b-LSW]	R	
44127	Star Voltage L2-N Sample #122	Float [32b-LSW]	R	
44129	Star Voltage L2-N Sample #123	Float [32b-LSW]	R	
44131	Star Voltage L2-N Sample #124	Float [32b-LSW]	R	
44133	Star Voltage L2-N Sample #125	Float [32b-LSW]	R	
44135	Star Voltage L2-N Sample #126	Float [32b-LSW]	R	
44137	Star Voltage L2-N Sample #127	Float [32b-LSW]	R	
44139	Star Voltage L3-N Sample #0	Float [32b-LSW]	R	
44141	Star Voltage L3-N Sample #1	Float [32b-LSW]	R	
44143	Star Voltage L3-N Sample #2	Float [32b-LSW]	R	
44145	Star Voltage L3-N Sample #3	Float [32b-LSW]	R	
44147	Star Voltage L3-N Sample #4	Float [32b-LSW]	R	
44149	Star Voltage L3-N Sample #5	Float [32b-LSW]	R	
44151	Star Voltage L3-N Sample #6	Float [32b-LSW]	R	
44153	Star Voltage L3-N Sample #7	Float [32b-LSW]	R	
44155	Star Voltage L3-N Sample #8	Float [32b-LSW]	R	
44157	Star Voltage L3-N Sample #9	Float [32b-LSW]	R	
44159	Star Voltage L3-N Sample #10	Float [32b-LSW]	R	
44161	Star Voltage L3-N Sample #11	Float [32b-LSW]	R	
44163	Star Voltage L3-N Sample #12	Float [32b-LSW]	R	
44165	Star Voltage L3-N Sample #13	Float [32b-LSW]	R	
44167	Star Voltage L3-N Sample #14	Float [32b-LSW]	R	
44169	Star Voltage L3-N Sample #15	Float [32b-LSW]	R	
44171	Star Voltage L3-N Sample #16	Float [32b-LSW]	R	
44173	Star Voltage L3-N Sample #17	Float [32b-LSW]	R	



Address Modbus	Description	Register Type	R/W	Default
44175	Star Voltage L3-N Sample #18	Float [32b-LSW]	R	
44177	Star Voltage L3-N Sample #19	Float [32b-LSW]	R	
44179	Star Voltage L3-N Sample #20	Float [32b-LSW]	R	
44181	Star Voltage L3-N Sample #21	Float [32b-LSW]	R	
44183	Star Voltage L3-N Sample #22	Float [32b-LSW]	R	
44185	Star Voltage L3-N Sample #23	Float [32b-LSW]	R	
44187	Star Voltage L3-N Sample #24	Float [32b-LSW]	R	
44189	Star Voltage L3-N Sample #25	Float [32b-LSW]	R	
44191	Star Voltage L3-N Sample #26	Float [32b-LSW]	R	
44193	Star Voltage L3-N Sample #27	Float [32b-LSW]	R	
44195	Star Voltage L3-N Sample #28	Float [32b-LSW]	R	
44197	Star Voltage L3-N Sample #29	Float [32b-LSW]	R	
44199	Star Voltage L3-N Sample #30	Float [32b-LSW]	R	
44201	Star Voltage L3-N Sample #31	Float [32b-LSW]	R	
44203	Star Voltage L3-N Sample #32	Float [32b-LSW]	R	
44205	Star Voltage L3-N Sample #33	Float [32b-LSW]	R	
44207	Star Voltage L3-N Sample #34	Float [32b-LSW]	R	
44209	Star Voltage L3-N Sample #35	Float [32b-LSW]	R	
44211	Star Voltage L3-N Sample #36	Float [32b-LSW]	R	
44213	Star Voltage L3-N Sample #37	Float [32b-LSW]	R	
44215	Star Voltage L3-N Sample #38	Float [32b-LSW]	R	
44217	Star Voltage L3-N Sample #39	Float [32b-LSW]	R	
44219	Star Voltage L3-N Sample #40	Float [32b-LSW]	R	
44221	Star Voltage L3-N Sample #41	Float [32b-LSW]	R	
44223	Star Voltage L3-N Sample #42	Float [32b-LSW]	R	
44225	Star Voltage L3-N Sample #43	Float [32b-LSW]	R	
44227	Star Voltage L3-N Sample #44	Float [32b-LSW]	R	
44229	Star Voltage L3-N Sample #45	Float [32b-LSW]	R	
44231	Star Voltage L3-N Sample #46	Float [32b-LSW]	R	
44233	Star Voltage L3-N Sample #47	Float [32b-LSW]	R	
44235	Star Voltage L3-N Sample #48	Float [32b-LSW]	R	
44237	Star Voltage L3-N Sample #49	Float [32b-LSW]	R	
44239	Star Voltage L3-N Sample #50	Float [32b-LSW]	R	
44241	Star Voltage L3-N Sample #51	Float [32b-LSW]	R	
44243	Star Voltage L3-N Sample #52	Float [32b-LSW]	R	
44245	Star Voltage L3-N Sample #53	Float [32b-LSW]	R	
44247	Star Voltage L3-N Sample #54	Float [32b-LSW]	R	
44249	Star Voltage L3-N Sample #55	Float [32b-LSW]	R	
44251	Star Voltage L3-N Sample #56	Float [32b-LSW]	R	
44253	Star Voltage L3-N Sample #57	Float [32b-LSW]	R	
44255	Star Voltage L3-N Sample #58	Float [32b-LSW]	R	
44257	Star Voltage L3-N Sample #59	Float [32b-LSW]	R	
44259	Star Voltage L3-N Sample #60	Float [32b-LSW]	R	
44261	Star Voltage L3-N Sample #61	Float [32b-LSW]	R	
44263	Star Voltage L3-N Sample #62	Float [32b-LSW]	R	
44265	Star Voltage L3-N Sample #63	Float [32b-LSW]	R	
44267	Star Voltage L3-N Sample #64	Float [32b-LSW]	R	
44269	Star Voltage L3-N Sample #65	Float [32b-LSW]	R	
44271	Star Voltage L3-N Sample #66	Float [32b-LSW]	R	
44273	Star Voltage L3-N Sample #67	Float [32b-LSW]	R	
44275	Star Voltage L3-N Sample #68	Float [32b-LSW]	R	
44277	Star Voltage L3-N Sample #69	Float [32b-LSW]	R	
44279	Star Voltage L3-N Sample #70	Float [32b-LSW]	R	
44281	Star Voltage L3-N Sample #71	Float [32b-LSW]	R	
44283	Star Voltage L3-N Sample #72	Float [32b-LSW]	R	
44285	Star Voltage L3-N Sample #73	Float [32b-LSW]	R	
44287	Star Voltage L3-N Sample #74	Float [32b-LSW]	R	
44289	Star Voltage L3-N Sample #75	Float [32b-LSW]	R	
44291	Star Voltage L3-N Sample #76	Float [32b-LSW]	R	
44293	Star Voltage L3-N Sample #77	Float [32b-LSW]	R	
44295	Star Voltage L3-N Sample #78	Float [32b-LSW]	R	
44297	Star Voltage L3-N Sample #79	Float [32b-LSW]	R	



Address Modbus	Description	Register Type	R/W	Default
44299	Star Voltage L3-N Sample #80	Float [32b-LSW]	R	
44301	Star Voltage L3-N Sample #81	Float [32b-LSW]	R	
44303	Star Voltage L3-N Sample #82	Float [32b-LSW]	R	
44305	Star Voltage L3-N Sample #83	Float [32b-LSW]	R	
44307	Star Voltage L3-N Sample #84	Float [32b-LSW]	R	
44309	Star Voltage L3-N Sample #85	Float [32b-LSW]	R	
44311	Star Voltage L3-N Sample #86	Float [32b-LSW]	R	
44313	Star Voltage L3-N Sample #87	Float [32b-LSW]	R	
44315	Star Voltage L3-N Sample #88	Float [32b-LSW]	R	
44317	Star Voltage L3-N Sample #89	Float [32b-LSW]	R	
44319	Star Voltage L3-N Sample #90	Float [32b-LSW]	R	
44321	Star Voltage L3-N Sample #91	Float [32b-LSW]	R	
44323	Star Voltage L3-N Sample #92	Float [32b-LSW]	R	
44325	Star Voltage L3-N Sample #93	Float [32b-LSW]	R	
44327	Star Voltage L3-N Sample #94	Float [32b-LSW]	R	
44329	Star Voltage L3-N Sample #95	Float [32b-LSW]	R	
44331	Star Voltage L3-N Sample #96	Float [32b-LSW]	R	
44333	Star Voltage L3-N Sample #97	Float [32b-LSW]	R	
44335	Star Voltage L3-N Sample #98	Float [32b-LSW]	R	
44337	Star Voltage L3-N Sample #99	Float [32b-LSW]	R	
44339	Star Voltage L3-N Sample #100	Float [32b-LSW]	R	
44341	Star Voltage L3-N Sample #101	Float [32b-LSW]	R	
44343	Star Voltage L3-N Sample #102	Float [32b-LSW]	R	
44345	Star Voltage L3-N Sample #103	Float [32b-LSW]	R	
44347	Star Voltage L3-N Sample #104	Float [32b-LSW]	R	
44349	Star Voltage L3-N Sample #105	Float [32b-LSW]	R	
44351	Star Voltage L3-N Sample #106	Float [32b-LSW]	R	
44353	Star Voltage L3-N Sample #107	Float [32b-LSW]	R	
44355	Star Voltage L3-N Sample #108	Float [32b-LSW]	R	
44357	Star Voltage L3-N Sample #109	Float [32b-LSW]	R	
44359	Star Voltage L3-N Sample #110	Float [32b-LSW]	R	
44361	Star Voltage L3-N Sample #111	Float [32b-LSW]	R	
44363	Star Voltage L3-N Sample #112	Float [32b-LSW]	R	
44365	Star Voltage L3-N Sample #113	Float [32b-LSW]	R	
44367	Star Voltage L3-N Sample #114	Float [32b-LSW]	R	
44369	Star Voltage L3-N Sample #115	Float [32b-LSW]	R	
44371	Star Voltage L3-N Sample #116	Float [32b-LSW]	R	
44373	Star Voltage L3-N Sample #117	Float [32b-LSW]	R	
44375	Star Voltage L3-N Sample #118	Float [32b-LSW]	R	
44377	Star Voltage L3-N Sample #119	Float [32b-LSW]	R	
44379	Star Voltage L3-N Sample #120	Float [32b-LSW]	R	
44381	Star Voltage L3-N Sample #121	Float [32b-LSW]	R	
44383	Star Voltage L3-N Sample #122	Float [32b-LSW]	R	
44385	Star Voltage L3-N Sample #123	Float [32b-LSW]	R	
44387	Star Voltage L3-N Sample #124	Float [32b-LSW]	R	
44389	Star Voltage L3-N Sample #125	Float [32b-LSW]	R	
44391	Star Voltage L3-N Sample #126	Float [32b-LSW]	R	
44393	Star Voltage L3-N Sample #127	Float [32b-LSW]	R	
44395	Line Voltage L1-L2 Sample #0	Float [32b-LSW]	R	
44397	Line Voltage L1-L2 Sample #1	Float [32b-LSW]	R	
44399	Line Voltage L1-L2 Sample #2	Float [32b-LSW]	R	
44401	Line Voltage L1-L2 Sample #3	Float [32b-LSW]	R	
44403	Line Voltage L1-L2 Sample #4	Float [32b-LSW]	R	
44405	Line Voltage L1-L2 Sample #5	Float [32b-LSW]	R	
44407	Line Voltage L1-L2 Sample #6	Float [32b-LSW]	R	
44409	Line Voltage L1-L2 Sample #7	Float [32b-LSW]	R	
44411	Line Voltage L1-L2 Sample #8	Float [32b-LSW]	R	
44413	Line Voltage L1-L2 Sample #9	Float [32b-LSW]	R	
44415	Line Voltage L1-L2 Sample #10	Float [32b-LSW]	R	
44417	Line Voltage L1-L2 Sample #11	Float [32b-LSW]	R	
44419	Line Voltage L1-L2 Sample #12	Float [32b-LSW]	R	
44421	Line Voltage L1-L2 Sample #13	Float [32b-LSW]	R	



Address Modbus	Description	Register Type	R/W	Default
44423	Line Voltage L1-L2 Sample #14	Float [32b-LSW]	R	
44425	Line Voltage L1-L2 Sample #15	Float [32b-LSW]	R	
44427	Line Voltage L1-L2 Sample #16	Float [32b-LSW]	R	
44429	Line Voltage L1-L2 Sample #17	Float [32b-LSW]	R	
44431	Line Voltage L1-L2 Sample #18	Float [32b-LSW]	R	
44433	Line Voltage L1-L2 Sample #19	Float [32b-LSW]	R	
44435	Line Voltage L1-L2 Sample #20	Float [32b-LSW]	R	
44437	Line Voltage L1-L2 Sample #21	Float [32b-LSW]	R	
44439	Line Voltage L1-L2 Sample #22	Float [32b-LSW]	R	
44441	Line Voltage L1-L2 Sample #23	Float [32b-LSW]	R	
44443	Line Voltage L1-L2 Sample #24	Float [32b-LSW]	R	
44445	Line Voltage L1-L2 Sample #25	Float [32b-LSW]	R	
44447	Line Voltage L1-L2 Sample #26	Float [32b-LSW]	R	
44449	Line Voltage L1-L2 Sample #27	Float [32b-LSW]	R	
44451	Line Voltage L1-L2 Sample #28	Float [32b-LSW]	R	
44453	Line Voltage L1-L2 Sample #29	Float [32b-LSW]	R	
44455	Line Voltage L1-L2 Sample #30	Float [32b-LSW]	R	
44457	Line Voltage L1-L2 Sample #31	Float [32b-LSW]	R	
44459	Line Voltage L1-L2 Sample #32	Float [32b-LSW]	R	
44461	Line Voltage L1-L2 Sample #33	Float [32b-LSW]	R	
44463	Line Voltage L1-L2 Sample #34	Float [32b-LSW]	R	
44465	Line Voltage L1-L2 Sample #35	Float [32b-LSW]	R	
44467	Line Voltage L1-L2 Sample #36	Float [32b-LSW]	R	
44469	Line Voltage L1-L2 Sample #37	Float [32b-LSW]	R	
44471	Line Voltage L1-L2 Sample #38	Float [32b-LSW]	R	
44473	Line Voltage L1-L2 Sample #39	Float [32b-LSW]	R	
44475	Line Voltage L1-L2 Sample #40	Float [32b-LSW]	R	
44477	Line Voltage L1-L2 Sample #41	Float [32b-LSW]	R	
44479	Line Voltage L1-L2 Sample #42	Float [32b-LSW]	R	
44481	Line Voltage L1-L2 Sample #43	Float [32b-LSW]	R	
44483	Line Voltage L1-L2 Sample #44	Float [32b-LSW]	R	
44485	Line Voltage L1-L2 Sample #45	Float [32b-LSW]	R	
44487	Line Voltage L1-L2 Sample #46	Float [32b-LSW]	R	
44489	Line Voltage L1-L2 Sample #47	Float [32b-LSW]	R	
44491	Line Voltage L1-L2 Sample #48	Float [32b-LSW]	R	
44493	Line Voltage L1-L2 Sample #49	Float [32b-LSW]	R	
44495	Line Voltage L1-L2 Sample #50	Float [32b-LSW]	R	
44497	Line Voltage L1-L2 Sample #51	Float [32b-LSW]	R	
44499	Line Voltage L1-L2 Sample #52	Float [32b-LSW]	R	
44501	Line Voltage L1-L2 Sample #53	Float [32b-LSW]	R	
44503	Line Voltage L1-L2 Sample #54	Float [32b-LSW]	R	
44505	Line Voltage L1-L2 Sample #55	Float [32b-LSW]	R	
44507	Line Voltage L1-L2 Sample #56	Float [32b-LSW]	R	
44509	Line Voltage L1-L2 Sample #57	Float [32b-LSW]	R	
44511	Line Voltage L1-L2 Sample #58	Float [32b-LSW]	R	
44513	Line Voltage L1-L2 Sample #59	Float [32b-LSW]	R	
44515	Line Voltage L1-L2 Sample #60	Float [32b-LSW]	R	
44517	Line Voltage L1-L2 Sample #61	Float [32b-LSW]	R	
44519	Line Voltage L1-L2 Sample #62	Float [32b-LSW]	R	
44521	Line Voltage L1-L2 Sample #63	Float [32b-LSW]	R	
44523	Line Voltage L1-L2 Sample #64	Float [32b-LSW]	R	
44525	Line Voltage L1-L2 Sample #65	Float [32b-LSW]	R	
44527	Line Voltage L1-L2 Sample #66	Float [32b-LSW]	R	
44529	Line Voltage L1-L2 Sample #67	Float [32b-LSW]	R	
44531	Line Voltage L1-L2 Sample #68	Float [32b-LSW]	R	
44533	Line Voltage L1-L2 Sample #69	Float [32b-LSW]	R	
44535	Line Voltage L1-L2 Sample #70	Float [32b-LSW]	R	
44537	Line Voltage L1-L2 Sample #71	Float [32b-LSW]	R	
44539	Line Voltage L1-L2 Sample #72	Float [32b-LSW]	R	
44541	Line Voltage L1-L2 Sample #73	Float [32b-LSW]	R	
44543	Line Voltage L1-L2 Sample #74	Float [32b-LSW]	R	
44545	Line Voltage L1-L2 Sample #75	Float [32b-LSW]	R	



Address Modbus	Description	Register Type	R/W	Default
44547	Line Voltage L1-L2 Sample #76	Float [32b-LSW]	R	
44549	Line Voltage L1-L2 Sample #77	Float [32b-LSW]	R	
44551	Line Voltage L1-L2 Sample #78	Float [32b-LSW]	R	
44553	Line Voltage L1-L2 Sample #79	Float [32b-LSW]	R	
44555	Line Voltage L1-L2 Sample #80	Float [32b-LSW]	R	
44557	Line Voltage L1-L2 Sample #81	Float [32b-LSW]	R	
44559	Line Voltage L1-L2 Sample #82	Float [32b-LSW]	R	
44561	Line Voltage L1-L2 Sample #83	Float [32b-LSW]	R	
44563	Line Voltage L1-L2 Sample #84	Float [32b-LSW]	R	
44565	Line Voltage L1-L2 Sample #85	Float [32b-LSW]	R	
44567	Line Voltage L1-L2 Sample #86	Float [32b-LSW]	R	
44569	Line Voltage L1-L2 Sample #87	Float [32b-LSW]	R	
44571	Line Voltage L1-L2 Sample #88	Float [32b-LSW]	R	
44573	Line Voltage L1-L2 Sample #89	Float [32b-LSW]	R	
44575	Line Voltage L1-L2 Sample #90	Float [32b-LSW]	R	
44577	Line Voltage L1-L2 Sample #91	Float [32b-LSW]	R	
44579	Line Voltage L1-L2 Sample #92	Float [32b-LSW]	R	
44581	Line Voltage L1-L2 Sample #93	Float [32b-LSW]	R	
44583	Line Voltage L1-L2 Sample #94	Float [32b-LSW]	R	
44585	Line Voltage L1-L2 Sample #95	Float [32b-LSW]	R	
44587	Line Voltage L1-L2 Sample #96	Float [32b-LSW]	R	
44589	Line Voltage L1-L2 Sample #97	Float [32b-LSW]	R	
44591	Line Voltage L1-L2 Sample #98	Float [32b-LSW]	R	
44593	Line Voltage L1-L2 Sample #99	Float [32b-LSW]	R	
44595	Line Voltage L1-L2 Sample #100	Float [32b-LSW]	R	
44597	Line Voltage L1-L2 Sample #101	Float [32b-LSW]	R	
44599	Line Voltage L1-L2 Sample #102	Float [32b-LSW]	R	
44601	Line Voltage L1-L2 Sample #103	Float [32b-LSW]	R	
44603	Line Voltage L1-L2 Sample #104	Float [32b-LSW]	R	
44605	Line Voltage L1-L2 Sample #105	Float [32b-LSW]	R	
44607	Line Voltage L1-L2 Sample #106	Float [32b-LSW]	R	
44609	Line Voltage L1-L2 Sample #107	Float [32b-LSW]	R	
44611	Line Voltage L1-L2 Sample #108	Float [32b-LSW]	R	
44613	Line Voltage L1-L2 Sample #109	Float [32b-LSW]	R	
44615	Line Voltage L1-L2 Sample #110	Float [32b-LSW]	R	
44617	Line Voltage L1-L2 Sample #111	Float [32b-LSW]	R	
44619	Line Voltage L1-L2 Sample #112	Float [32b-LSW]	R	
44621	Line Voltage L1-L2 Sample #113	Float [32b-LSW]	R	
44623	Line Voltage L1-L2 Sample #114	Float [32b-LSW]	R	
44625	Line Voltage L1-L2 Sample #115	Float [32b-LSW]	R	
44627	Line Voltage L1-L2 Sample #116	Float [32b-LSW]	R	
44629	Line Voltage L1-L2 Sample #117	Float [32b-LSW]	R	
44631	Line Voltage L1-L2 Sample #118	Float [32b-LSW]	R	
44633	Line Voltage L1-L2 Sample #119	Float [32b-LSW]	R	
44635	Line Voltage L1-L2 Sample #120	Float [32b-LSW]	R	
44637	Line Voltage L1-L2 Sample #121	Float [32b-LSW]	R	
44639	Line Voltage L1-L2 Sample #122	Float [32b-LSW]	R	
44641	Line Voltage L1-L2 Sample #123	Float [32b-LSW]	R	
44643	Line Voltage L1-L2 Sample #124	Float [32b-LSW]	R	
44645	Line Voltage L1-L2 Sample #125	Float [32b-LSW]	R	
44647	Line Voltage L1-L2 Sample #126	Float [32b-LSW]	R	
44649	Line Voltage L1-L2 Sample #127	Float [32b-LSW]	R	
44651	Line Voltage L2-L3 Sample #0	Float [32b-LSW]	R	
44653	Line Voltage L2-L3 Sample #1	Float [32b-LSW]	R	
44655	Line Voltage L2-L3 Sample #2	Float [32b-LSW]	R	
44657	Line Voltage L2-L3 Sample #3	Float [32b-LSW]	R	
44659	Line Voltage L2-L3 Sample #4	Float [32b-LSW]	R	
44661	Line Voltage L2-L3 Sample #5	Float [32b-LSW]	R	
44663	Line Voltage L2-L3 Sample #6	Float [32b-LSW]	R	
44665	Line Voltage L2-L3 Sample #7	Float [32b-LSW]	R	
44667	Line Voltage L2-L3 Sample #8	Float [32b-LSW]	R	
44669	Line Voltage L2-L3 Sample #9	Float [32b-LSW]	R	



Address Modbus	Description	Register Type	R/W	Default
44671	Line Voltage L2-L3 Sample #10	Float [32b-LSW]	R	
44673	Line Voltage L2-L3 Sample #11	Float [32b-LSW]	R	
44675	Line Voltage L2-L3 Sample #12	Float [32b-LSW]	R	
44677	Line Voltage L2-L3 Sample #13	Float [32b-LSW]	R	
44679	Line Voltage L2-L3 Sample #14	Float [32b-LSW]	R	
44681	Line Voltage L2-L3 Sample #15	Float [32b-LSW]	R	
44683	Line Voltage L2-L3 Sample #16	Float [32b-LSW]	R	
44685	Line Voltage L2-L3 Sample #17	Float [32b-LSW]	R	
44687	Line Voltage L2-L3 Sample #18	Float [32b-LSW]	R	
44689	Line Voltage L2-L3 Sample #19	Float [32b-LSW]	R	
44691	Line Voltage L2-L3 Sample #20	Float [32b-LSW]	R	
44693	Line Voltage L2-L3 Sample #21	Float [32b-LSW]	R	
44695	Line Voltage L2-L3 Sample #22	Float [32b-LSW]	R	
44697	Line Voltage L2-L3 Sample #23	Float [32b-LSW]	R	
44699	Line Voltage L2-L3 Sample #24	Float [32b-LSW]	R	
44701	Line Voltage L2-L3 Sample #25	Float [32b-LSW]	R	
44703	Line Voltage L2-L3 Sample #26	Float [32b-LSW]	R	
44705	Line Voltage L2-L3 Sample #27	Float [32b-LSW]	R	
44707	Line Voltage L2-L3 Sample #28	Float [32b-LSW]	R	
44709	Line Voltage L2-L3 Sample #29	Float [32b-LSW]	R	
44711	Line Voltage L2-L3 Sample #30	Float [32b-LSW]	R	
44713	Line Voltage L2-L3 Sample #31	Float [32b-LSW]	R	
44715	Line Voltage L2-L3 Sample #32	Float [32b-LSW]	R	
44717	Line Voltage L2-L3 Sample #33	Float [32b-LSW]	R	
44719	Line Voltage L2-L3 Sample #34	Float [32b-LSW]	R	
44721	Line Voltage L2-L3 Sample #35	Float [32b-LSW]	R	
44723	Line Voltage L2-L3 Sample #36	Float [32b-LSW]	R	
44725	Line Voltage L2-L3 Sample #37	Float [32b-LSW]	R	
44727	Line Voltage L2-L3 Sample #38	Float [32b-LSW]	R	
44729	Line Voltage L2-L3 Sample #39	Float [32b-LSW]	R	
44731	Line Voltage L2-L3 Sample #40	Float [32b-LSW]	R	
44733	Line Voltage L2-L3 Sample #41	Float [32b-LSW]	R	
44735	Line Voltage L2-L3 Sample #42	Float [32b-LSW]	R	
44737	Line Voltage L2-L3 Sample #43	Float [32b-LSW]	R	
44739	Line Voltage L2-L3 Sample #44	Float [32b-LSW]	R	
44741	Line Voltage L2-L3 Sample #45	Float [32b-LSW]	R	
44743	Line Voltage L2-L3 Sample #46	Float [32b-LSW]	R	
44745	Line Voltage L2-L3 Sample #47	Float [32b-LSW]	R	
44747	Line Voltage L2-L3 Sample #48	Float [32b-LSW]	R	
44749	Line Voltage L2-L3 Sample #49	Float [32b-LSW]	R	
44751	Line Voltage L2-L3 Sample #50	Float [32b-LSW]	R	
44753	Line Voltage L2-L3 Sample #51	Float [32b-LSW]	R	
44755	Line Voltage L2-L3 Sample #52	Float [32b-LSW]	R	
44757	Line Voltage L2-L3 Sample #53	Float [32b-LSW]	R	
44759	Line Voltage L2-L3 Sample #54	Float [32b-LSW]	R	
44761	Line Voltage L2-L3 Sample #55	Float [32b-LSW]	R	
44763	Line Voltage L2-L3 Sample #56	Float [32b-LSW]	R	
44765	Line Voltage L2-L3 Sample #57	Float [32b-LSW]	R	
44767	Line Voltage L2-L3 Sample #58	Float [32b-LSW]	R	
44769	Line Voltage L2-L3 Sample #59	Float [32b-LSW]	R	
44771	Line Voltage L2-L3 Sample #60	Float [32b-LSW]	R	
44773	Line Voltage L2-L3 Sample #61	Float [32b-LSW]	R	
44775	Line Voltage L2-L3 Sample #62	Float [32b-LSW]	R	
44777	Line Voltage L2-L3 Sample #63	Float [32b-LSW]	R	
44779	Line Voltage L2-L3 Sample #64	Float [32b-LSW]	R	
44781	Line Voltage L2-L3 Sample #65	Float [32b-LSW]	R	
44783	Line Voltage L2-L3 Sample #66	Float [32b-LSW]	R	
44785	Line Voltage L2-L3 Sample #67	Float [32b-LSW]	R	
44787	Line Voltage L2-L3 Sample #68	Float [32b-LSW]	R	
44789	Line Voltage L2-L3 Sample #69	Float [32b-LSW]	R	
44791	Line Voltage L2-L3 Sample #70	Float [32b-LSW]	R	
44793	Line Voltage L2-L3 Sample #71	Float [32b-LSW]	R	



Address Modbus	Description	Register Type	R/W	Default
44795	Line Voltage L2-L3 Sample #72	Float [32b-LSW]	R	
44797	Line Voltage L2-L3 Sample #73	Float [32b-LSW]	R	
44799	Line Voltage L2-L3 Sample #74	Float [32b-LSW]	R	
44801	Line Voltage L2-L3 Sample #75	Float [32b-LSW]	R	
44803	Line Voltage L2-L3 Sample #76	Float [32b-LSW]	R	
44805	Line Voltage L2-L3 Sample #77	Float [32b-LSW]	R	
44807	Line Voltage L2-L3 Sample #78	Float [32b-LSW]	R	
44809	Line Voltage L2-L3 Sample #79	Float [32b-LSW]	R	
44811	Line Voltage L2-L3 Sample #80	Float [32b-LSW]	R	
44813	Line Voltage L2-L3 Sample #81	Float [32b-LSW]	R	
44815	Line Voltage L2-L3 Sample #82	Float [32b-LSW]	R	
44817	Line Voltage L2-L3 Sample #83	Float [32b-LSW]	R	
44819	Line Voltage L2-L3 Sample #84	Float [32b-LSW]	R	
44821	Line Voltage L2-L3 Sample #85	Float [32b-LSW]	R	
44823	Line Voltage L2-L3 Sample #86	Float [32b-LSW]	R	
44825	Line Voltage L2-L3 Sample #87	Float [32b-LSW]	R	
44827	Line Voltage L2-L3 Sample #88	Float [32b-LSW]	R	
44829	Line Voltage L2-L3 Sample #89	Float [32b-LSW]	R	
44831	Line Voltage L2-L3 Sample #90	Float [32b-LSW]	R	
44833	Line Voltage L2-L3 Sample #91	Float [32b-LSW]	R	
44835	Line Voltage L2-L3 Sample #92	Float [32b-LSW]	R	
44837	Line Voltage L2-L3 Sample #93	Float [32b-LSW]	R	
44839	Line Voltage L2-L3 Sample #94	Float [32b-LSW]	R	
44841	Line Voltage L2-L3 Sample #95	Float [32b-LSW]	R	
44843	Line Voltage L2-L3 Sample #96	Float [32b-LSW]	R	
44845	Line Voltage L2-L3 Sample #97	Float [32b-LSW]	R	
44847	Line Voltage L2-L3 Sample #98	Float [32b-LSW]	R	
44849	Line Voltage L2-L3 Sample #99	Float [32b-LSW]	R	
44851	Line Voltage L2-L3 Sample #100	Float [32b-LSW]	R	
44853	Line Voltage L2-L3 Sample #101	Float [32b-LSW]	R	
44855	Line Voltage L2-L3 Sample #102	Float [32b-LSW]	R	
44857	Line Voltage L2-L3 Sample #103	Float [32b-LSW]	R	
44859	Line Voltage L2-L3 Sample #104	Float [32b-LSW]	R	
44861	Line Voltage L2-L3 Sample #105	Float [32b-LSW]	R	
44863	Line Voltage L2-L3 Sample #106	Float [32b-LSW]	R	
44865	Line Voltage L2-L3 Sample #107	Float [32b-LSW]	R	
44867	Line Voltage L2-L3 Sample #108	Float [32b-LSW]	R	
44869	Line Voltage L2-L3 Sample #109	Float [32b-LSW]	R	
44871	Line Voltage L2-L3 Sample #110	Float [32b-LSW]	R	
44873	Line Voltage L2-L3 Sample #111	Float [32b-LSW]	R	
44875	Line Voltage L2-L3 Sample #112	Float [32b-LSW]	R	
44877	Line Voltage L2-L3 Sample #113	Float [32b-LSW]	R	
44879	Line Voltage L2-L3 Sample #114	Float [32b-LSW]	R	
44881	Line Voltage L2-L3 Sample #115	Float [32b-LSW]	R	
44883	Line Voltage L2-L3 Sample #116	Float [32b-LSW]	R	
44885	Line Voltage L2-L3 Sample #117	Float [32b-LSW]	R	
44887	Line Voltage L2-L3 Sample #118	Float [32b-LSW]	R	
44889	Line Voltage L2-L3 Sample #119	Float [32b-LSW]	R	
44891	Line Voltage L2-L3 Sample #120	Float [32b-LSW]	R	
44893	Line Voltage L2-L3 Sample #121	Float [32b-LSW]	R	
44895	Line Voltage L2-L3 Sample #122	Float [32b-LSW]	R	
44897	Line Voltage L2-L3 Sample #123	Float [32b-LSW]	R	
44899	Line Voltage L2-L3 Sample #124	Float [32b-LSW]	R	
44901	Line Voltage L2-L3 Sample #125	Float [32b-LSW]	R	
44903	Line Voltage L2-L3 Sample #126	Float [32b-LSW]	R	
44905	Line Voltage L2-L3 Sample #127	Float [32b-LSW]	R	
44907	Line Voltage L3-L1 Sample #0	Float [32b-LSW]	R	
44909	Line Voltage L3-L1 Sample #1	Float [32b-LSW]	R	
44911	Line Voltage L3-L1 Sample #2	Float [32b-LSW]	R	
44913	Line Voltage L3-L1 Sample #3	Float [32b-LSW]	R	
44915	Line Voltage L3-L1 Sample #4	Float [32b-LSW]	R	
44917	Line Voltage L3-L1 Sample #5	Float [32b-LSW]	R	



Address Modbus	Description	Register Type	R/W	Default
44919	Line Voltage L3-L1 Sample #6	Float [32b-LSW]	R	
44921	Line Voltage L3-L1 Sample #7	Float [32b-LSW]	R	
44923	Line Voltage L3-L1 Sample #8	Float [32b-LSW]	R	
44925	Line Voltage L3-L1 Sample #9	Float [32b-LSW]	R	
44927	Line Voltage L3-L1 Sample #10	Float [32b-LSW]	R	
44929	Line Voltage L3-L1 Sample #11	Float [32b-LSW]	R	
44931	Line Voltage L3-L1 Sample #12	Float [32b-LSW]	R	
44933	Line Voltage L3-L1 Sample #13	Float [32b-LSW]	R	
44935	Line Voltage L3-L1 Sample #14	Float [32b-LSW]	R	
44937	Line Voltage L3-L1 Sample #15	Float [32b-LSW]	R	
44939	Line Voltage L3-L1 Sample #16	Float [32b-LSW]	R	
44941	Line Voltage L3-L1 Sample #17	Float [32b-LSW]	R	
44943	Line Voltage L3-L1 Sample #18	Float [32b-LSW]	R	
44945	Line Voltage L3-L1 Sample #19	Float [32b-LSW]	R	
44947	Line Voltage L3-L1 Sample #20	Float [32b-LSW]	R	
44949	Line Voltage L3-L1 Sample #21	Float [32b-LSW]	R	
44951	Line Voltage L3-L1 Sample #22	Float [32b-LSW]	R	
44953	Line Voltage L3-L1 Sample #23	Float [32b-LSW]	R	
44955	Line Voltage L3-L1 Sample #24	Float [32b-LSW]	R	
44957	Line Voltage L3-L1 Sample #25	Float [32b-LSW]	R	
44959	Line Voltage L3-L1 Sample #26	Float [32b-LSW]	R	
44961	Line Voltage L3-L1 Sample #27	Float [32b-LSW]	R	
44963	Line Voltage L3-L1 Sample #28	Float [32b-LSW]	R	
44965	Line Voltage L3-L1 Sample #29	Float [32b-LSW]	R	
44967	Line Voltage L3-L1 Sample #30	Float [32b-LSW]	R	
44969	Line Voltage L3-L1 Sample #31	Float [32b-LSW]	R	
44971	Line Voltage L3-L1 Sample #32	Float [32b-LSW]	R	
44973	Line Voltage L3-L1 Sample #33	Float [32b-LSW]	R	
44975	Line Voltage L3-L1 Sample #34	Float [32b-LSW]	R	
44977	Line Voltage L3-L1 Sample #35	Float [32b-LSW]	R	
44979	Line Voltage L3-L1 Sample #36	Float [32b-LSW]	R	
44981	Line Voltage L3-L1 Sample #37	Float [32b-LSW]	R	
44983	Line Voltage L3-L1 Sample #38	Float [32b-LSW]	R	
44985	Line Voltage L3-L1 Sample #39	Float [32b-LSW]	R	
44987	Line Voltage L3-L1 Sample #40	Float [32b-LSW]	R	
44989	Line Voltage L3-L1 Sample #41	Float [32b-LSW]	R	
44991	Line Voltage L3-L1 Sample #42	Float [32b-LSW]	R	
44993	Line Voltage L3-L1 Sample #43	Float [32b-LSW]	R	
44995	Line Voltage L3-L1 Sample #44	Float [32b-LSW]	R	
44997	Line Voltage L3-L1 Sample #45	Float [32b-LSW]	R	
44999	Line Voltage L3-L1 Sample #46	Float [32b-LSW]	R	
45001	Line Voltage L3-L1 Sample #47	Float [32b-LSW]	R	
45003	Line Voltage L3-L1 Sample #48	Float [32b-LSW]	R	
45005	Line Voltage L3-L1 Sample #49	Float [32b-LSW]	R	
45007	Line Voltage L3-L1 Sample #50	Float [32b-LSW]	R	
45009	Line Voltage L3-L1 Sample #51	Float [32b-LSW]	R	
45011	Line Voltage L3-L1 Sample #52	Float [32b-LSW]	R	
45013	Line Voltage L3-L1 Sample #53	Float [32b-LSW]	R	
45015	Line Voltage L3-L1 Sample #54	Float [32b-LSW]	R	
45017	Line Voltage L3-L1 Sample #55	Float [32b-LSW]	R	
45019	Line Voltage L3-L1 Sample #56	Float [32b-LSW]	R	
45021	Line Voltage L3-L1 Sample #57	Float [32b-LSW]	R	
45023	Line Voltage L3-L1 Sample #58	Float [32b-LSW]	R	
45025	Line Voltage L3-L1 Sample #59	Float [32b-LSW]	R	
45027	Line Voltage L3-L1 Sample #60	Float [32b-LSW]	R	
45029	Line Voltage L3-L1 Sample #61	Float [32b-LSW]	R	
45031	Line Voltage L3-L1 Sample #62	Float [32b-LSW]	R	
45033	Line Voltage L3-L1 Sample #63	Float [32b-LSW]	R	
45035	Line Voltage L3-L1 Sample #64	Float [32b-LSW]	R	
45037	Line Voltage L3-L1 Sample #65	Float [32b-LSW]	R	
45039	Line Voltage L3-L1 Sample #66	Float [32b-LSW]	R	
45041	Line Voltage L3-L1 Sample #67	Float [32b-LSW]	R	



Address Modbus	Description	Register Type	R/W	Default
45043	Line Voltage L3-L1 Sample #68	Float [32b-LSW]	R	
45045	Line Voltage L3-L1 Sample #69	Float [32b-LSW]	R	
45047	Line Voltage L3-L1 Sample #70	Float [32b-LSW]	R	
45049	Line Voltage L3-L1 Sample #71	Float [32b-LSW]	R	
45051	Line Voltage L3-L1 Sample #72	Float [32b-LSW]	R	
45053	Line Voltage L3-L1 Sample #73	Float [32b-LSW]	R	
45055	Line Voltage L3-L1 Sample #74	Float [32b-LSW]	R	
45057	Line Voltage L3-L1 Sample #75	Float [32b-LSW]	R	
45059	Line Voltage L3-L1 Sample #76	Float [32b-LSW]	R	
45061	Line Voltage L3-L1 Sample #77	Float [32b-LSW]	R	
45063	Line Voltage L3-L1 Sample #78	Float [32b-LSW]	R	
45065	Line Voltage L3-L1 Sample #79	Float [32b-LSW]	R	
45067	Line Voltage L3-L1 Sample #80	Float [32b-LSW]	R	
45069	Line Voltage L3-L1 Sample #81	Float [32b-LSW]	R	
45071	Line Voltage L3-L1 Sample #82	Float [32b-LSW]	R	
45073	Line Voltage L3-L1 Sample #83	Float [32b-LSW]	R	
45075	Line Voltage L3-L1 Sample #84	Float [32b-LSW]	R	
45077	Line Voltage L3-L1 Sample #85	Float [32b-LSW]	R	
45079	Line Voltage L3-L1 Sample #86	Float [32b-LSW]	R	
45081	Line Voltage L3-L1 Sample #87	Float [32b-LSW]	R	
45083	Line Voltage L3-L1 Sample #88	Float [32b-LSW]	R	
45085	Line Voltage L3-L1 Sample #89	Float [32b-LSW]	R	
45087	Line Voltage L3-L1 Sample #90	Float [32b-LSW]	R	
45089	Line Voltage L3-L1 Sample #91	Float [32b-LSW]	R	
45091	Line Voltage L3-L1 Sample #92	Float [32b-LSW]	R	
45093	Line Voltage L3-L1 Sample #93	Float [32b-LSW]	R	
45095	Line Voltage L3-L1 Sample #94	Float [32b-LSW]	R	
45097	Line Voltage L3-L1 Sample #95	Float [32b-LSW]	R	
45099	Line Voltage L3-L1 Sample #96	Float [32b-LSW]	R	
45101	Line Voltage L3-L1 Sample #97	Float [32b-LSW]	R	
45103	Line Voltage L3-L1 Sample #98	Float [32b-LSW]	R	
45105	Line Voltage L3-L1 Sample #99	Float [32b-LSW]	R	
45107	Line Voltage L3-L1 Sample #100	Float [32b-LSW]	R	
45109	Line Voltage L3-L1 Sample #101	Float [32b-LSW]	R	
45111	Line Voltage L3-L1 Sample #102	Float [32b-LSW]	R	
45113	Line Voltage L3-L1 Sample #103	Float [32b-LSW]	R	
45115	Line Voltage L3-L1 Sample #104	Float [32b-LSW]	R	
45117	Line Voltage L3-L1 Sample #105	Float [32b-LSW]	R	
45119	Line Voltage L3-L1 Sample #106	Float [32b-LSW]	R	
45121	Line Voltage L3-L1 Sample #107	Float [32b-LSW]	R	
45123	Line Voltage L3-L1 Sample #108	Float [32b-LSW]	R	
45125	Line Voltage L3-L1 Sample #109	Float [32b-LSW]	R	
45127	Line Voltage L3-L1 Sample #110	Float [32b-LSW]	R	
45129	Line Voltage L3-L1 Sample #111	Float [32b-LSW]	R	
45131	Line Voltage L3-L1 Sample #112	Float [32b-LSW]	R	
45133	Line Voltage L3-L1 Sample #113	Float [32b-LSW]	R	
45135	Line Voltage L3-L1 Sample #114	Float [32b-LSW]	R	
45137	Line Voltage L3-L1 Sample #115	Float [32b-LSW]	R	
45139	Line Voltage L3-L1 Sample #116	Float [32b-LSW]	R	
45141	Line Voltage L3-L1 Sample #117	Float [32b-LSW]	R	
45143	Line Voltage L3-L1 Sample #118	Float [32b-LSW]	R	
45145	Line Voltage L3-L1 Sample #119	Float [32b-LSW]	R	
45147	Line Voltage L3-L1 Sample #120	Float [32b-LSW]	R	
45149	Line Voltage L3-L1 Sample #121	Float [32b-LSW]	R	
45151	Line Voltage L3-L1 Sample #122	Float [32b-LSW]	R	
45153	Line Voltage L3-L1 Sample #123	Float [32b-LSW]	R	
45155	Line Voltage L3-L1 Sample #124	Float [32b-LSW]	R	
45157	Line Voltage L3-L1 Sample #125	Float [32b-LSW]	R	
45159	Line Voltage L3-L1 Sample #126	Float [32b-LSW]	R	
45161	Line Voltage L3-L1 Sample #127	Float [32b-LSW]	R	
45163	Line Current L1 Sample #0	Float [32b-LSW]	R	
45165	Line Current L1 Sample #1	Float [32b-LSW]	R	



Address Modbus	Description	Register Type	R/W	Default
45167	Line Current L1 Sample #2	Float [32b-LSW]	R	
45169	Line Current L1 Sample #3	Float [32b-LSW]	R	
45171	Line Current L1 Sample #4	Float [32b-LSW]	R	
45173	Line Current L1 Sample #5	Float [32b-LSW]	R	
45175	Line Current L1 Sample #6	Float [32b-LSW]	R	
45177	Line Current L1 Sample #7	Float [32b-LSW]	R	
45179	Line Current L1 Sample #8	Float [32b-LSW]	R	
45181	Line Current L1 Sample #9	Float [32b-LSW]	R	
45183	Line Current L1 Sample #10	Float [32b-LSW]	R	
45185	Line Current L1 Sample #11	Float [32b-LSW]	R	
45187	Line Current L1 Sample #12	Float [32b-LSW]	R	
45189	Line Current L1 Sample #13	Float [32b-LSW]	R	
45191	Line Current L1 Sample #14	Float [32b-LSW]	R	
45193	Line Current L1 Sample #15	Float [32b-LSW]	R	
45195	Line Current L1 Sample #16	Float [32b-LSW]	R	
45197	Line Current L1 Sample #17	Float [32b-LSW]	R	
45199	Line Current L1 Sample #18	Float [32b-LSW]	R	
45201	Line Current L1 Sample #19	Float [32b-LSW]	R	
45203	Line Current L1 Sample #20	Float [32b-LSW]	R	
45205	Line Current L1 Sample #21	Float [32b-LSW]	R	
45207	Line Current L1 Sample #22	Float [32b-LSW]	R	
45209	Line Current L1 Sample #23	Float [32b-LSW]	R	
45211	Line Current L1 Sample #24	Float [32b-LSW]	R	
45213	Line Current L1 Sample #25	Float [32b-LSW]	R	
45215	Line Current L1 Sample #26	Float [32b-LSW]	R	
45217	Line Current L1 Sample #27	Float [32b-LSW]	R	
45219	Line Current L1 Sample #28	Float [32b-LSW]	R	
45221	Line Current L1 Sample #29	Float [32b-LSW]	R	
45223	Line Current L1 Sample #30	Float [32b-LSW]	R	
45225	Line Current L1 Sample #31	Float [32b-LSW]	R	
45227	Line Current L1 Sample #32	Float [32b-LSW]	R	
45229	Line Current L1 Sample #33	Float [32b-LSW]	R	
45231	Line Current L1 Sample #34	Float [32b-LSW]	R	
45233	Line Current L1 Sample #35	Float [32b-LSW]	R	
45235	Line Current L1 Sample #36	Float [32b-LSW]	R	
45237	Line Current L1 Sample #37	Float [32b-LSW]	R	
45239	Line Current L1 Sample #38	Float [32b-LSW]	R	
45241	Line Current L1 Sample #39	Float [32b-LSW]	R	
45243	Line Current L1 Sample #40	Float [32b-LSW]	R	
45245	Line Current L1 Sample #41	Float [32b-LSW]	R	
45247	Line Current L1 Sample #42	Float [32b-LSW]	R	
45249	Line Current L1 Sample #43	Float [32b-LSW]	R	
45251	Line Current L1 Sample #44	Float [32b-LSW]	R	
45253	Line Current L1 Sample #45	Float [32b-LSW]	R	
45255	Line Current L1 Sample #46	Float [32b-LSW]	R	
45257	Line Current L1 Sample #47	Float [32b-LSW]	R	
45259	Line Current L1 Sample #48	Float [32b-LSW]	R	
45261	Line Current L1 Sample #49	Float [32b-LSW]	R	
45263	Line Current L1 Sample #50	Float [32b-LSW]	R	
45265	Line Current L1 Sample #51	Float [32b-LSW]	R	
45267	Line Current L1 Sample #52	Float [32b-LSW]	R	
45269	Line Current L1 Sample #53	Float [32b-LSW]	R	
45271	Line Current L1 Sample #54	Float [32b-LSW]	R	
45273	Line Current L1 Sample #55	Float [32b-LSW]	R	
45275	Line Current L1 Sample #56	Float [32b-LSW]	R	
45277	Line Current L1 Sample #57	Float [32b-LSW]	R	
45279	Line Current L1 Sample #58	Float [32b-LSW]	R	
45281	Line Current L1 Sample #59	Float [32b-LSW]	R	
45283	Line Current L1 Sample #60	Float [32b-LSW]	R	
45285	Line Current L1 Sample #61	Float [32b-LSW]	R	
45287	Line Current L1 Sample #62	Float [32b-LSW]	R	
45289	Line Current L1 Sample #63	Float [32b-LSW]	R	



Address Modbus	Description	Register Type	R/W	Default
45291	Line Current L1 Sample #64	Float [32b-LSW]	R	
45293	Line Current L1 Sample #65	Float [32b-LSW]	R	
45295	Line Current L1 Sample #66	Float [32b-LSW]	R	
45297	Line Current L1 Sample #67	Float [32b-LSW]	R	
45299	Line Current L1 Sample #68	Float [32b-LSW]	R	
45301	Line Current L1 Sample #69	Float [32b-LSW]	R	
45303	Line Current L1 Sample #70	Float [32b-LSW]	R	
45305	Line Current L1 Sample #71	Float [32b-LSW]	R	
45307	Line Current L1 Sample #72	Float [32b-LSW]	R	
45309	Line Current L1 Sample #73	Float [32b-LSW]	R	
45311	Line Current L1 Sample #74	Float [32b-LSW]	R	
45313	Line Current L1 Sample #75	Float [32b-LSW]	R	
45315	Line Current L1 Sample #76	Float [32b-LSW]	R	
45317	Line Current L1 Sample #77	Float [32b-LSW]	R	
45319	Line Current L1 Sample #78	Float [32b-LSW]	R	
45321	Line Current L1 Sample #79	Float [32b-LSW]	R	
45323	Line Current L1 Sample #80	Float [32b-LSW]	R	
45325	Line Current L1 Sample #81	Float [32b-LSW]	R	
45327	Line Current L1 Sample #82	Float [32b-LSW]	R	
45329	Line Current L1 Sample #83	Float [32b-LSW]	R	
45331	Line Current L1 Sample #84	Float [32b-LSW]	R	
45333	Line Current L1 Sample #85	Float [32b-LSW]	R	
45335	Line Current L1 Sample #86	Float [32b-LSW]	R	
45337	Line Current L1 Sample #87	Float [32b-LSW]	R	
45339	Line Current L1 Sample #88	Float [32b-LSW]	R	
45341	Line Current L1 Sample #89	Float [32b-LSW]	R	
45343	Line Current L1 Sample #90	Float [32b-LSW]	R	
45345	Line Current L1 Sample #91	Float [32b-LSW]	R	
45347	Line Current L1 Sample #92	Float [32b-LSW]	R	
45349	Line Current L1 Sample #93	Float [32b-LSW]	R	
45351	Line Current L1 Sample #94	Float [32b-LSW]	R	
45353	Line Current L1 Sample #95	Float [32b-LSW]	R	
45355	Line Current L1 Sample #96	Float [32b-LSW]	R	
45357	Line Current L1 Sample #97	Float [32b-LSW]	R	
45359	Line Current L1 Sample #98	Float [32b-LSW]	R	
45361	Line Current L1 Sample #99	Float [32b-LSW]	R	
45363	Line Current L1 Sample #100	Float [32b-LSW]	R	
45365	Line Current L1 Sample #101	Float [32b-LSW]	R	
45367	Line Current L1 Sample #102	Float [32b-LSW]	R	
45369	Line Current L1 Sample #103	Float [32b-LSW]	R	
45371	Line Current L1 Sample #104	Float [32b-LSW]	R	
45373	Line Current L1 Sample #105	Float [32b-LSW]	R	
45375	Line Current L1 Sample #106	Float [32b-LSW]	R	
45377	Line Current L1 Sample #107	Float [32b-LSW]	R	
45379	Line Current L1 Sample #108	Float [32b-LSW]	R	
45381	Line Current L1 Sample #109	Float [32b-LSW]	R	
45383	Line Current L1 Sample #110	Float [32b-LSW]	R	
45385	Line Current L1 Sample #111	Float [32b-LSW]	R	
45387	Line Current L1 Sample #112	Float [32b-LSW]	R	
45389	Line Current L1 Sample #113	Float [32b-LSW]	R	
45391	Line Current L1 Sample #114	Float [32b-LSW]	R	
45393	Line Current L1 Sample #115	Float [32b-LSW]	R	
45395	Line Current L1 Sample #116	Float [32b-LSW]	R	
45397	Line Current L1 Sample #117	Float [32b-LSW]	R	
45399	Line Current L1 Sample #118	Float [32b-LSW]	R	
45401	Line Current L1 Sample #119	Float [32b-LSW]	R	
45403	Line Current L1 Sample #120	Float [32b-LSW]	R	
45405	Line Current L1 Sample #121	Float [32b-LSW]	R	
45407	Line Current L1 Sample #122	Float [32b-LSW]	R	
45409	Line Current L1 Sample #123	Float [32b-LSW]	R	
45411	Line Current L1 Sample #124	Float [32b-LSW]	R	
45413	Line Current L1 Sample #125	Float [32b-LSW]	R	



Address Modbus	Description	Register Type	R/W	Default
45415	Line Current L1 Sample #126	Float [32b-LSW]	R	
45417	Line Current L1 Sample #127	Float [32b-LSW]	R	
45419	Line Current L2 Sample #0	Float [32b-LSW]	R	
45421	Line Current L2 Sample #1	Float [32b-LSW]	R	
45423	Line Current L2 Sample #2	Float [32b-LSW]	R	
45425	Line Current L2 Sample #3	Float [32b-LSW]	R	
45427	Line Current L2 Sample #4	Float [32b-LSW]	R	
45429	Line Current L2 Sample #5	Float [32b-LSW]	R	
45431	Line Current L2 Sample #6	Float [32b-LSW]	R	
45433	Line Current L2 Sample #7	Float [32b-LSW]	R	
45435	Line Current L2 Sample #8	Float [32b-LSW]	R	
45437	Line Current L2 Sample #9	Float [32b-LSW]	R	
45439	Line Current L2 Sample #10	Float [32b-LSW]	R	
45441	Line Current L2 Sample #11	Float [32b-LSW]	R	
45443	Line Current L2 Sample #12	Float [32b-LSW]	R	
45445	Line Current L2 Sample #13	Float [32b-LSW]	R	
45447	Line Current L2 Sample #14	Float [32b-LSW]	R	
45449	Line Current L2 Sample #15	Float [32b-LSW]	R	
45451	Line Current L2 Sample #16	Float [32b-LSW]	R	
45453	Line Current L2 Sample #17	Float [32b-LSW]	R	
45455	Line Current L2 Sample #18	Float [32b-LSW]	R	
45457	Line Current L2 Sample #19	Float [32b-LSW]	R	
45459	Line Current L2 Sample #20	Float [32b-LSW]	R	
45461	Line Current L2 Sample #21	Float [32b-LSW]	R	
45463	Line Current L2 Sample #22	Float [32b-LSW]	R	
45465	Line Current L2 Sample #23	Float [32b-LSW]	R	
45467	Line Current L2 Sample #24	Float [32b-LSW]	R	
45469	Line Current L2 Sample #25	Float [32b-LSW]	R	
45471	Line Current L2 Sample #26	Float [32b-LSW]	R	
45473	Line Current L2 Sample #27	Float [32b-LSW]	R	
45475	Line Current L2 Sample #28	Float [32b-LSW]	R	
45477	Line Current L2 Sample #29	Float [32b-LSW]	R	
45479	Line Current L2 Sample #30	Float [32b-LSW]	R	
45481	Line Current L2 Sample #31	Float [32b-LSW]	R	
45483	Line Current L2 Sample #32	Float [32b-LSW]	R	
45485	Line Current L2 Sample #33	Float [32b-LSW]	R	
45487	Line Current L2 Sample #34	Float [32b-LSW]	R	
45489	Line Current L2 Sample #35	Float [32b-LSW]	R	
45491	Line Current L2 Sample #36	Float [32b-LSW]	R	
45493	Line Current L2 Sample #37	Float [32b-LSW]	R	
45495	Line Current L2 Sample #38	Float [32b-LSW]	R	
45497	Line Current L2 Sample #39	Float [32b-LSW]	R	
45499	Line Current L2 Sample #40	Float [32b-LSW]	R	
45501	Line Current L2 Sample #41	Float [32b-LSW]	R	
45503	Line Current L2 Sample #42	Float [32b-LSW]	R	
45505	Line Current L2 Sample #43	Float [32b-LSW]	R	
45507	Line Current L2 Sample #44	Float [32b-LSW]	R	
45509	Line Current L2 Sample #45	Float [32b-LSW]	R	
45511	Line Current L2 Sample #46	Float [32b-LSW]	R	
45513	Line Current L2 Sample #47	Float [32b-LSW]	R	
45515	Line Current L2 Sample #48	Float [32b-LSW]	R	
45517	Line Current L2 Sample #49	Float [32b-LSW]	R	
45519	Line Current L2 Sample #50	Float [32b-LSW]	R	
45521	Line Current L2 Sample #51	Float [32b-LSW]	R	
45523	Line Current L2 Sample #52	Float [32b-LSW]	R	
45525	Line Current L2 Sample #53	Float [32b-LSW]	R	
45527	Line Current L2 Sample #54	Float [32b-LSW]	R	
45529	Line Current L2 Sample #55	Float [32b-LSW]	R	
45531	Line Current L2 Sample #56	Float [32b-LSW]	R	
45533	Line Current L2 Sample #57	Float [32b-LSW]	R	
45535	Line Current L2 Sample #58	Float [32b-LSW]	R	
45537	Line Current L2 Sample #59	Float [32b-LSW]	R	



Address Modbus	Description	Register Type	R/W	Default
45539	Line Current L2 Sample #60	Float [32b-LSW]	R	
45541	Line Current L2 Sample #61	Float [32b-LSW]	R	
45543	Line Current L2 Sample #62	Float [32b-LSW]	R	
45545	Line Current L2 Sample #63	Float [32b-LSW]	R	
45547	Line Current L2 Sample #64	Float [32b-LSW]	R	
45549	Line Current L2 Sample #65	Float [32b-LSW]	R	
45551	Line Current L2 Sample #66	Float [32b-LSW]	R	
45553	Line Current L2 Sample #67	Float [32b-LSW]	R	
45555	Line Current L2 Sample #68	Float [32b-LSW]	R	
45557	Line Current L2 Sample #69	Float [32b-LSW]	R	
45559	Line Current L2 Sample #70	Float [32b-LSW]	R	
45561	Line Current L2 Sample #71	Float [32b-LSW]	R	
45563	Line Current L2 Sample #72	Float [32b-LSW]	R	
45565	Line Current L2 Sample #73	Float [32b-LSW]	R	
45567	Line Current L2 Sample #74	Float [32b-LSW]	R	
45569	Line Current L2 Sample #75	Float [32b-LSW]	R	
45571	Line Current L2 Sample #76	Float [32b-LSW]	R	
45573	Line Current L2 Sample #77	Float [32b-LSW]	R	
45575	Line Current L2 Sample #78	Float [32b-LSW]	R	
45577	Line Current L2 Sample #79	Float [32b-LSW]	R	
45579	Line Current L2 Sample #80	Float [32b-LSW]	R	
45581	Line Current L2 Sample #81	Float [32b-LSW]	R	
45583	Line Current L2 Sample #82	Float [32b-LSW]	R	
45585	Line Current L2 Sample #83	Float [32b-LSW]	R	
45587	Line Current L2 Sample #84	Float [32b-LSW]	R	
45589	Line Current L2 Sample #85	Float [32b-LSW]	R	
45591	Line Current L2 Sample #86	Float [32b-LSW]	R	
45593	Line Current L2 Sample #87	Float [32b-LSW]	R	
45595	Line Current L2 Sample #88	Float [32b-LSW]	R	
45597	Line Current L2 Sample #89	Float [32b-LSW]	R	
45599	Line Current L2 Sample #90	Float [32b-LSW]	R	
45601	Line Current L2 Sample #91	Float [32b-LSW]	R	
45603	Line Current L2 Sample #92	Float [32b-LSW]	R	
45605	Line Current L2 Sample #93	Float [32b-LSW]	R	
45607	Line Current L2 Sample #94	Float [32b-LSW]	R	
45609	Line Current L2 Sample #95	Float [32b-LSW]	R	
45611	Line Current L2 Sample #96	Float [32b-LSW]	R	
45613	Line Current L2 Sample #97	Float [32b-LSW]	R	
45615	Line Current L2 Sample #98	Float [32b-LSW]	R	
45617	Line Current L2 Sample #99	Float [32b-LSW]	R	
45619	Line Current L2 Sample #100	Float [32b-LSW]	R	
45621	Line Current L2 Sample #101	Float [32b-LSW]	R	
45623	Line Current L2 Sample #102	Float [32b-LSW]	R	
45625	Line Current L2 Sample #103	Float [32b-LSW]	R	
45627	Line Current L2 Sample #104	Float [32b-LSW]	R	
45629	Line Current L2 Sample #105	Float [32b-LSW]	R	
45631	Line Current L2 Sample #106	Float [32b-LSW]	R	
45633	Line Current L2 Sample #107	Float [32b-LSW]	R	
45635	Line Current L2 Sample #108	Float [32b-LSW]	R	
45637	Line Current L2 Sample #109	Float [32b-LSW]	R	
45639	Line Current L2 Sample #110	Float [32b-LSW]	R	
45641	Line Current L2 Sample #111	Float [32b-LSW]	R	
45643	Line Current L2 Sample #112	Float [32b-LSW]	R	
45645	Line Current L2 Sample #113	Float [32b-LSW]	R	
45647	Line Current L2 Sample #114	Float [32b-LSW]	R	
45649	Line Current L2 Sample #115	Float [32b-LSW]	R	
45651	Line Current L2 Sample #116	Float [32b-LSW]	R	
45653	Line Current L2 Sample #117	Float [32b-LSW]	R	
45655	Line Current L2 Sample #118	Float [32b-LSW]	R	
45657	Line Current L2 Sample #119	Float [32b-LSW]	R	
45659	Line Current L2 Sample #120	Float [32b-LSW]	R	
45661	Line Current L2 Sample #121	Float [32b-LSW]	R	



Address Modbus	Description	Register Type	R/W	Default
45663	Line Current L2 Sample #122	Float [32b-LSW]	R	
45665	Line Current L2 Sample #123	Float [32b-LSW]	R	
45667	Line Current L2 Sample #124	Float [32b-LSW]	R	
45669	Line Current L2 Sample #125	Float [32b-LSW]	R	
45671	Line Current L2 Sample #126	Float [32b-LSW]	R	
45673	Line Current L2 Sample #127	Float [32b-LSW]	R	
45675	Line Current L3 Sample #0	Float [32b-LSW]	R	
45677	Line Current L3 Sample #1	Float [32b-LSW]	R	
45679	Line Current L3 Sample #2	Float [32b-LSW]	R	
45681	Line Current L3 Sample #3	Float [32b-LSW]	R	
45683	Line Current L3 Sample #4	Float [32b-LSW]	R	
45685	Line Current L3 Sample #5	Float [32b-LSW]	R	
45687	Line Current L3 Sample #6	Float [32b-LSW]	R	
45689	Line Current L3 Sample #7	Float [32b-LSW]	R	
45691	Line Current L3 Sample #8	Float [32b-LSW]	R	
45693	Line Current L3 Sample #9	Float [32b-LSW]	R	
45695	Line Current L3 Sample #10	Float [32b-LSW]	R	
45697	Line Current L3 Sample #11	Float [32b-LSW]	R	
45699	Line Current L3 Sample #12	Float [32b-LSW]	R	
45701	Line Current L3 Sample #13	Float [32b-LSW]	R	
45703	Line Current L3 Sample #14	Float [32b-LSW]	R	
45705	Line Current L3 Sample #15	Float [32b-LSW]	R	
45707	Line Current L3 Sample #16	Float [32b-LSW]	R	
45709	Line Current L3 Sample #17	Float [32b-LSW]	R	
45711	Line Current L3 Sample #18	Float [32b-LSW]	R	
45713	Line Current L3 Sample #19	Float [32b-LSW]	R	
45715	Line Current L3 Sample #20	Float [32b-LSW]	R	
45717	Line Current L3 Sample #21	Float [32b-LSW]	R	
45719	Line Current L3 Sample #22	Float [32b-LSW]	R	
45721	Line Current L3 Sample #23	Float [32b-LSW]	R	
45723	Line Current L3 Sample #24	Float [32b-LSW]	R	
45725	Line Current L3 Sample #25	Float [32b-LSW]	R	
45727	Line Current L3 Sample #26	Float [32b-LSW]	R	
45729	Line Current L3 Sample #27	Float [32b-LSW]	R	
45731	Line Current L3 Sample #28	Float [32b-LSW]	R	
45733	Line Current L3 Sample #29	Float [32b-LSW]	R	
45735	Line Current L3 Sample #30	Float [32b-LSW]	R	
45737	Line Current L3 Sample #31	Float [32b-LSW]	R	
45739	Line Current L3 Sample #32	Float [32b-LSW]	R	
45741	Line Current L3 Sample #33	Float [32b-LSW]	R	
45743	Line Current L3 Sample #34	Float [32b-LSW]	R	
45745	Line Current L3 Sample #35	Float [32b-LSW]	R	
45747	Line Current L3 Sample #36	Float [32b-LSW]	R	
45749	Line Current L3 Sample #37	Float [32b-LSW]	R	
45751	Line Current L3 Sample #38	Float [32b-LSW]	R	
45753	Line Current L3 Sample #39	Float [32b-LSW]	R	
45755	Line Current L3 Sample #40	Float [32b-LSW]	R	
45757	Line Current L3 Sample #41	Float [32b-LSW]	R	
45759	Line Current L3 Sample #42	Float [32b-LSW]	R	
45761	Line Current L3 Sample #43	Float [32b-LSW]	R	
45763	Line Current L3 Sample #44	Float [32b-LSW]	R	
45765	Line Current L3 Sample #45	Float [32b-LSW]	R	
45767	Line Current L3 Sample #46	Float [32b-LSW]	R	
45769	Line Current L3 Sample #47	Float [32b-LSW]	R	
45771	Line Current L3 Sample #48	Float [32b-LSW]	R	
45773	Line Current L3 Sample #49	Float [32b-LSW]	R	
45775	Line Current L3 Sample #50	Float [32b-LSW]	R	
45777	Line Current L3 Sample #51	Float [32b-LSW]	R	
45779	Line Current L3 Sample #52	Float [32b-LSW]	R	
45781	Line Current L3 Sample #53	Float [32b-LSW]	R	
45783	Line Current L3 Sample #54	Float [32b-LSW]	R	
45785	Line Current L3 Sample #55	Float [32b-LSW]	R	



Address Modbus	Description	Register Type	R/W	Default
45787	Line Current L3 Sample #56	Float [32b-LSW]	R	
45789	Line Current L3 Sample #57	Float [32b-LSW]	R	
45791	Line Current L3 Sample #58	Float [32b-LSW]	R	
45793	Line Current L3 Sample #59	Float [32b-LSW]	R	
45795	Line Current L3 Sample #60	Float [32b-LSW]	R	
45797	Line Current L3 Sample #61	Float [32b-LSW]	R	
45799	Line Current L3 Sample #62	Float [32b-LSW]	R	
45801	Line Current L3 Sample #63	Float [32b-LSW]	R	
45803	Line Current L3 Sample #64	Float [32b-LSW]	R	
45805	Line Current L3 Sample #65	Float [32b-LSW]	R	
45807	Line Current L3 Sample #66	Float [32b-LSW]	R	
45809	Line Current L3 Sample #67	Float [32b-LSW]	R	
45811	Line Current L3 Sample #68	Float [32b-LSW]	R	
45813	Line Current L3 Sample #69	Float [32b-LSW]	R	
45815	Line Current L3 Sample #70	Float [32b-LSW]	R	
45817	Line Current L3 Sample #71	Float [32b-LSW]	R	
45819	Line Current L3 Sample #72	Float [32b-LSW]	R	
45821	Line Current L3 Sample #73	Float [32b-LSW]	R	
45823	Line Current L3 Sample #74	Float [32b-LSW]	R	
45825	Line Current L3 Sample #75	Float [32b-LSW]	R	
45827	Line Current L3 Sample #76	Float [32b-LSW]	R	
45829	Line Current L3 Sample #77	Float [32b-LSW]	R	
45831	Line Current L3 Sample #78	Float [32b-LSW]	R	
45833	Line Current L3 Sample #79	Float [32b-LSW]	R	
45835	Line Current L3 Sample #80	Float [32b-LSW]	R	
45837	Line Current L3 Sample #81	Float [32b-LSW]	R	
45839	Line Current L3 Sample #82	Float [32b-LSW]	R	
45841	Line Current L3 Sample #83	Float [32b-LSW]	R	
45843	Line Current L3 Sample #84	Float [32b-LSW]	R	
45845	Line Current L3 Sample #85	Float [32b-LSW]	R	
45847	Line Current L3 Sample #86	Float [32b-LSW]	R	
45849	Line Current L3 Sample #87	Float [32b-LSW]	R	
45851	Line Current L3 Sample #88	Float [32b-LSW]	R	
45853	Line Current L3 Sample #89	Float [32b-LSW]	R	
45855	Line Current L3 Sample #90	Float [32b-LSW]	R	
45857	Line Current L3 Sample #91	Float [32b-LSW]	R	
45859	Line Current L3 Sample #92	Float [32b-LSW]	R	
45861	Line Current L3 Sample #93	Float [32b-LSW]	R	
45863	Line Current L3 Sample #94	Float [32b-LSW]	R	
45865	Line Current L3 Sample #95	Float [32b-LSW]	R	
45867	Line Current L3 Sample #96	Float [32b-LSW]	R	
45869	Line Current L3 Sample #97	Float [32b-LSW]	R	
45871	Line Current L3 Sample #98	Float [32b-LSW]	R	
45873	Line Current L3 Sample #99	Float [32b-LSW]	R	
45875	Line Current L3 Sample #100	Float [32b-LSW]	R	
45877	Line Current L3 Sample #101	Float [32b-LSW]	R	
45879	Line Current L3 Sample #102	Float [32b-LSW]	R	
45881	Line Current L3 Sample #103	Float [32b-LSW]	R	
45883	Line Current L3 Sample #104	Float [32b-LSW]	R	
45885	Line Current L3 Sample #105	Float [32b-LSW]	R	
45887	Line Current L3 Sample #106	Float [32b-LSW]	R	
45889	Line Current L3 Sample #107	Float [32b-LSW]	R	
45891	Line Current L3 Sample #108	Float [32b-LSW]	R	
45893	Line Current L3 Sample #109	Float [32b-LSW]	R	
45895	Line Current L3 Sample #110	Float [32b-LSW]	R	
45897	Line Current L3 Sample #111	Float [32b-LSW]	R	
45899	Line Current L3 Sample #112	Float [32b-LSW]	R	
45901	Line Current L3 Sample #113	Float [32b-LSW]	R	
45903	Line Current L3 Sample #114	Float [32b-LSW]	R	
45905	Line Current L3 Sample #115	Float [32b-LSW]	R	
45907	Line Current L3 Sample #116	Float [32b-LSW]	R	
45909	Line Current L3 Sample #117	Float [32b-LSW]	R	



Address Modbus	Description	Register Type	R/W	Default
45911	Line Current L3 Sample #118	Float [32b-LSW]	R	
45913	Line Current L3 Sample #119	Float [32b-LSW]	R	
45915	Line Current L3 Sample #120	Float [32b-LSW]	R	
45917	Line Current L3 Sample #121	Float [32b-LSW]	R	
45919	Line Current L3 Sample #122	Float [32b-LSW]	R	
45921	Line Current L3 Sample #123	Float [32b-LSW]	R	
45923	Line Current L3 Sample #124	Float [32b-LSW]	R	
45925	Line Current L3 Sample #125	Float [32b-LSW]	R	
45927	Line Current L3 Sample #126	Float [32b-LSW]	R	
45929	Line Current L3 Sample #127	Float [32b-LSW]	R	
45931	Line Current N Sample #0	Float [32b-LSW]	R	
45933	Line Current N Sample #1	Float [32b-LSW]	R	
45935	Line Current N Sample #2	Float [32b-LSW]	R	
45937	Line Current N Sample #3	Float [32b-LSW]	R	
45939	Line Current N Sample #4	Float [32b-LSW]	R	
45941	Line Current N Sample #5	Float [32b-LSW]	R	
45943	Line Current N Sample #6	Float [32b-LSW]	R	
45945	Line Current N Sample #7	Float [32b-LSW]	R	
45947	Line Current N Sample #8	Float [32b-LSW]	R	
45949	Line Current N Sample #9	Float [32b-LSW]	R	
45951	Line Current N Sample #10	Float [32b-LSW]	R	
45953	Line Current N Sample #11	Float [32b-LSW]	R	
45955	Line Current N Sample #12	Float [32b-LSW]	R	
45957	Line Current N Sample #13	Float [32b-LSW]	R	
45959	Line Current N Sample #14	Float [32b-LSW]	R	
45961	Line Current N Sample #15	Float [32b-LSW]	R	
45963	Line Current N Sample #16	Float [32b-LSW]	R	
45965	Line Current N Sample #17	Float [32b-LSW]	R	
45967	Line Current N Sample #18	Float [32b-LSW]	R	
45969	Line Current N Sample #19	Float [32b-LSW]	R	
45971	Line Current N Sample #20	Float [32b-LSW]	R	
45973	Line Current N Sample #21	Float [32b-LSW]	R	
45975	Line Current N Sample #22	Float [32b-LSW]	R	
45977	Line Current N Sample #23	Float [32b-LSW]	R	
45979	Line Current N Sample #24	Float [32b-LSW]	R	
45981	Line Current N Sample #25	Float [32b-LSW]	R	
45983	Line Current N Sample #26	Float [32b-LSW]	R	
45985	Line Current N Sample #27	Float [32b-LSW]	R	
45987	Line Current N Sample #28	Float [32b-LSW]	R	
45989	Line Current N Sample #29	Float [32b-LSW]	R	
45991	Line Current N Sample #30	Float [32b-LSW]	R	
45993	Line Current N Sample #31	Float [32b-LSW]	R	
45995	Line Current N Sample #32	Float [32b-LSW]	R	
45997	Line Current N Sample #33	Float [32b-LSW]	R	
45999	Line Current N Sample #34	Float [32b-LSW]	R	
46001	Line Current N Sample #35	Float [32b-LSW]	R	
46003	Line Current N Sample #36	Float [32b-LSW]	R	
46005	Line Current N Sample #37	Float [32b-LSW]	R	
46007	Line Current N Sample #38	Float [32b-LSW]	R	
46009	Line Current N Sample #39	Float [32b-LSW]	R	
46011	Line Current N Sample #40	Float [32b-LSW]	R	
46013	Line Current N Sample #41	Float [32b-LSW]	R	
46015	Line Current N Sample #42	Float [32b-LSW]	R	
46017	Line Current N Sample #43	Float [32b-LSW]	R	
46019	Line Current N Sample #44	Float [32b-LSW]	R	
46021	Line Current N Sample #45	Float [32b-LSW]	R	
46023	Line Current N Sample #46	Float [32b-LSW]	R	
46025	Line Current N Sample #47	Float [32b-LSW]	R	
46027	Line Current N Sample #48	Float [32b-LSW]	R	
46029	Line Current N Sample #49	Float [32b-LSW]	R	
46031	Line Current N Sample #50	Float [32b-LSW]	R	
46033	Line Current N Sample #51	Float [32b-LSW]	R	



Address Modbus	Description	Register Type	R/W	Default
46035	Line Current N Sample #52	Float [32b-LSW]	R	
46037	Line Current N Sample #53	Float [32b-LSW]	R	
46039	Line Current N Sample #54	Float [32b-LSW]	R	
46041	Line Current N Sample #55	Float [32b-LSW]	R	
46043	Line Current N Sample #56	Float [32b-LSW]	R	
46045	Line Current N Sample #57	Float [32b-LSW]	R	
46047	Line Current N Sample #58	Float [32b-LSW]	R	
46049	Line Current N Sample #59	Float [32b-LSW]	R	
46051	Line Current N Sample #60	Float [32b-LSW]	R	
46053	Line Current N Sample #61	Float [32b-LSW]	R	
46055	Line Current N Sample #62	Float [32b-LSW]	R	
46057	Line Current N Sample #63	Float [32b-LSW]	R	
46059	Line Current N Sample #64	Float [32b-LSW]	R	
46061	Line Current N Sample #65	Float [32b-LSW]	R	
46063	Line Current N Sample #66	Float [32b-LSW]	R	
46065	Line Current N Sample #67	Float [32b-LSW]	R	
46067	Line Current N Sample #68	Float [32b-LSW]	R	
46069	Line Current N Sample #69	Float [32b-LSW]	R	
46071	Line Current N Sample #70	Float [32b-LSW]	R	
46073	Line Current N Sample #71	Float [32b-LSW]	R	
46075	Line Current N Sample #72	Float [32b-LSW]	R	
46077	Line Current N Sample #73	Float [32b-LSW]	R	
46079	Line Current N Sample #74	Float [32b-LSW]	R	
46081	Line Current N Sample #75	Float [32b-LSW]	R	
46083	Line Current N Sample #76	Float [32b-LSW]	R	
46085	Line Current N Sample #77	Float [32b-LSW]	R	
46087	Line Current N Sample #78	Float [32b-LSW]	R	
46089	Line Current N Sample #79	Float [32b-LSW]	R	
46091	Line Current N Sample #80	Float [32b-LSW]	R	
46093	Line Current N Sample #81	Float [32b-LSW]	R	
46095	Line Current N Sample #82	Float [32b-LSW]	R	
46097	Line Current N Sample #83	Float [32b-LSW]	R	
46099	Line Current N Sample #84	Float [32b-LSW]	R	
46101	Line Current N Sample #85	Float [32b-LSW]	R	
46103	Line Current N Sample #86	Float [32b-LSW]	R	
46105	Line Current N Sample #87	Float [32b-LSW]	R	
46107	Line Current N Sample #88	Float [32b-LSW]	R	
46109	Line Current N Sample #89	Float [32b-LSW]	R	
46111	Line Current N Sample #90	Float [32b-LSW]	R	
46113	Line Current N Sample #91	Float [32b-LSW]	R	
46115	Line Current N Sample #92	Float [32b-LSW]	R	
46117	Line Current N Sample #93	Float [32b-LSW]	R	
46119	Line Current N Sample #94	Float [32b-LSW]	R	
46121	Line Current N Sample #95	Float [32b-LSW]	R	
46123	Line Current N Sample #96	Float [32b-LSW]	R	
46125	Line Current N Sample #97	Float [32b-LSW]	R	
46127	Line Current N Sample #98	Float [32b-LSW]	R	
46129	Line Current N Sample #99	Float [32b-LSW]	R	
46131	Line Current N Sample #100	Float [32b-LSW]	R	
46133	Line Current N Sample #101	Float [32b-LSW]	R	
46135	Line Current N Sample #102	Float [32b-LSW]	R	
46137	Line Current N Sample #103	Float [32b-LSW]	R	
46139	Line Current N Sample #104	Float [32b-LSW]	R	
46141	Line Current N Sample #105	Float [32b-LSW]	R	
46143	Line Current N Sample #106	Float [32b-LSW]	R	
46145	Line Current N Sample #107	Float [32b-LSW]	R	
46147	Line Current N Sample #108	Float [32b-LSW]	R	
46149	Line Current N Sample #109	Float [32b-LSW]	R	
46151	Line Current N Sample #110	Float [32b-LSW]	R	
46153	Line Current N Sample #111	Float [32b-LSW]	R	
46155	Line Current N Sample #112	Float [32b-LSW]	R	
46157	Line Current N Sample #113	Float [32b-LSW]	R	



Address Modbus	Description	Register Type	R/W	Default
46159	Line Current N Sample #114	Float [32b-LSW]	R	
46161	Line Current N Sample #115	Float [32b-LSW]	R	
46163	Line Current N Sample #116	Float [32b-LSW]	R	
46165	Line Current N Sample #117	Float [32b-LSW]	R	
46167	Line Current N Sample #118	Float [32b-LSW]	R	
46169	Line Current N Sample #119	Float [32b-LSW]	R	
46171	Line Current N Sample #120	Float [32b-LSW]	R	
46173	Line Current N Sample #121	Float [32b-LSW]	R	
46175	Line Current N Sample #122	Float [32b-LSW]	R	
46177	Line Current N Sample #123	Float [32b-LSW]	R	
46179	Line Current N Sample #124	Float [32b-LSW]	R	
46181	Line Current N Sample #125	Float [32b-LSW]	R	
46183	Line Current N Sample #126	Float [32b-LSW]	R	
46185	Line Current N Sample #127	Float [32b-LSW]	R	

**Note 1):**

Il comando "save energy command" può scrivere al massimo 32 bit contemporaneamente. Si prega di suddividere i registri di energia in 2 coppie di registri Long[32b-LSW] o in 4 registri singoli short [16b] e utilizzare il comando 0xBABA.

Esempio:

Per impostare 1024 in "Active energy line 1", scrivere:

0x0400 in reg. 40245  
 0x0000 in reg. 40246  
 0xBABA in reg. 40244  
 0x0000 in reg. 40247  
 0x0000 in reg. 40248  
 0xBABA in reg. 40244

**LEGENDA:**

Short [16b] = Signed Short (16 bit)  
 UShort [16b] = Unsigned Short (16 bit)

Long [32b-MSW] = Signed Long (32 bit - MSW First Register)  
 Long [32b-LWS] = Signed Long (32 bit - LSW First Register)  
 ULong [32b-LSW] = Unsigned Long (32 bit - LSW First Register)  
 ULong [32b] = Unsigned Long (32 bit)

Float [32b-MSW] = Float (32 bit - MSW First Register)  
 Float [32b-LSW] = Float (32 bit - LSW First Register)

UInt [16b] = Unsigned Integer (16 bit)  
 UInt [32b-MSW] = Unsigned Integer (32 bit - MSW First Register)  
 Int [64b-LSW] = Signed Long Long (64 bit - LSW First Register)



## **D.E.M. SpA**

Zona Ind. Villanova 20  
32013 Longarone (BL)  
ITALIA

[www.dem-it.com](http://www.dem-it.com)  
[www.qeed.it](http://www.qeed.it)

Poiché gli standard, le specifiche e il design cambiano di volta in volta, si prega di chiedere conferma delle informazioni fornite in questa pubblicazione.