

QE-POWER-M



Visit the **QE-POWER-M** page
for news, updates and downloads



CONTENTS

Product overview.....	3
Specifiche del prodotto.....	3
Technical specifications.....	4
Electrical characteristics.....	4
Available measurements.....	5
Communication characteristics.....	5
General data.....	6
Order codes.....	6
Connection and installation.....	7
RS485 BUS termination.....	8
Status LEDs.....	8
Digital output alarm.....	9
Accuracy (acc. to EN50470-3 and EN62053-24).....	9
Product features.....	10
Modbus.....	10
RTC (only PLUS version).....	10
Inputs/outputs.....	10

Status LEDs.....	10
Digital alarm.....	10
Device configuration.....	11
Dip-switch Modbus RTU address and baud rate setting.....	11
Functionality configuration.....	11
Q-WIZARD.....	11
Third-party Modbus Master.....	11
Function 03 Hexadecimal (Read Holding Registers).....	12
Function 06 Hexadecimal (Write Single Holding Register).....	13
Function 10 Hexadecimal (Write Multiple Registers).....	14
Configuration register 40007.....	15
Register map.....	16



SAFETY WARNINGS AND CAUTIONS

The following warnings and cautions must be observed to ensure personal safety and prevent damage.



Death or **serious injury** may result from failure to heed this warning.



It is necessary to comply with national regulations when installing and picking materials for power lines.



Material damage or **serious personal injury** may result from failure to heed this warning.



Repairs and modifications must be carried out only by the manufacturer. It is forbidden to open the case and make any changes to the device. Tampering with the device will invalidate the warranty.



The manufacturer **declines all responsibility** for electrical safety in the event of improper use of the equipment.



ATTENTION: Class II object, in accordance with the standard 'EN 61140:2004-05 "Protection against electrical contacts - Common aspects for installations and equipment - Equipotential bonding", **grounding of the instrument is prohibited** as this would damage the device and reduce the safety of the installation.



The product described in this document may only be used for the specified application. The maximum performance data and environmental conditions specified in the product data sheet must be observed. Proper transport and storage, as well as professional assembly, installation, handling and maintenance are required for the correct and safe operation of the device.



It is essential to read the entire contents of this manual before carrying out any work.

Use under ambient conditions other than those specified, application of signals or voltages other than those specified, may cause significant deviations from the specified measurement tolerances, which may be irreversible.

Installation and commissioning must be carried out by qualified personnel only.



Before commissioning, make sure that:

- the maximum values for all connections are not exceeded; refer to the product data sheet;
- the connection cables are not damaged or live during wiring;
- the direction of current flow and phase rotation are correct.

During installation, ensure that a switch or circuit-breaker is near the product and easily accessible.

The unit must be uninstalled if safe operation can no longer be guaranteed (e.g. visible damage). Disconnect all connections in this case. The unit should be returned to the manufacturer or to an authorised service centre for repair.



Although the contents of this document have been checked for accuracy, it may contain errors or inconsistencies and we cannot guarantee its completeness or accuracy.



This document is subject to periodic revision and updating. QEED reserves the right to make changes to the product and/or its technical documentation at any time in the interests of continuous quality improvement. Always consult the latest version of the documentation available on the website:

www.qeed.it

If you find any errors or missing information in this document, please notify us by e-mail to:

technical@qeed.it



WARNING: High-intensity magnetic fields may alter the values measured by the transformer. Avoid installation near: permanent magnets, electromagnets, or iron masses. If irregularities are detected, reposition or move the unit to a more suitable location.



Disposal of waste electrical and electronic equipment (applicable in the European Union and other countries with separate collection). The symbol on the product or its packaging indicates that the product should not be treated as household waste. Instead, it will be handed over to an authorised collection point for the recycling of electrical and electronic waste. Ensuring that the product is disposed of properly will prevent potential negative effects on the environment and human health, which could otherwise be caused by inappropriate waste management of the product. Recycling materials helps to conserve natural resources. For further information, please contact your local authority, waste disposal service or the retailer from whom you purchased the product.



Failure to observe the warnings may result in damage to the equipment or failure to operate as intended.



Please note that the information on the nameplate must be observed.



PRODUCT OVERVIEW

The QE-POWER-M is a single-phase AC power analyser (1 DIN case) with a universal input for current transformers that can accept any type of current sensor (with voltage output $0\div333\text{mV}$ or current $1\text{A}/5\text{A}$ and Rogowski probes), available in 2 versions with different measurements.

It complies with class 0.5S (kWh) of EN62053-22 and class 0.5S (kVARh) of EN62053-24 and has an accuracy of $\pm 0.5\%$ RDG. The QE-POWER-M is capable of TRMS (voltage/current) measurements.

A digital contact (MOSFET), configurable as a pulse or alarm output, is available as an alternative to the RS485 terminal.

Power/error/communication/output status LEDs are on the front of the case.

RS485 serial interface for communication with Modbus RTU protocol, either from the **Q-WIZARD configuration tool**, or with third party Modbus masters by acting on register map registers.

Ready for DIN rail mounting with T-BUS terminal (optional) for fast connection with hot insertion/removal option.

Product specification

- Bidirectional energy measurement
- Complies with class 0.5S (kWh) of EN62053-22
- Complies with class 0.5S (kVARh) of EN62053-24
- Accuracy $\pm 0.5\%$ RDG
- Amperometric inputs for transformers with secondary ($1\text{A}/5\text{A}$, $0\div333\text{mV}$, Rogowski coils)
- TRMS measurement (voltage/current)
- One pulse output (MOSFET) for alarms (alternative to RS485 output on terminals)
- RS485 serial interface on terminals or T-BUS
- Front LED alarm indication
- Available in 2 versions: STD and PLUS

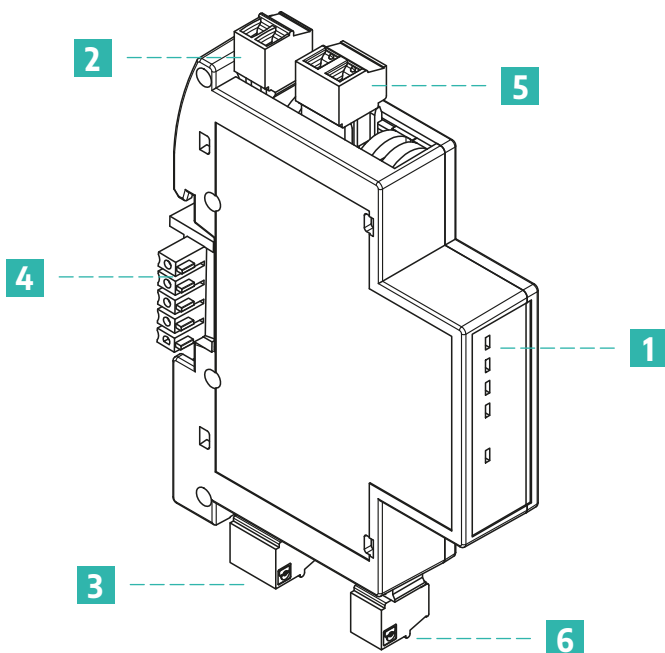

- 1 Status LEDs
- 2 Power supply terminals
- 3 Modbus RTU terminals
- 4 T-BUS terminal for both power supply and Modbus RTU communication (optional)
- 5 Voltage input
- 6 Current input



TECHNICAL SPECIFICATIONS

Electrical characteristics

Power supply	10÷40 V _{DC} or 20÷28 V _{AC} @ 50/60Hz
Current consumption	1,2 W max
Isolation	4 kV _{RMS} between power supply and measurement inputs 4 kV _{RMS} between RS485 and measurement inputs 1,5 kV _{RMS} between power supply and RS485
Voltage input	Direct connection up to 300 V _{RMS} maximum (40÷70 Hz) Transformation ratio for voltage and current transformers (configurable from Q-WIZARD or registers)
Current input	1 A / 5 A 0÷ 333 mV
Output	SPST MOSFET dry digital contact (<40V, <100mA)
Communication interface	RS485 Modbus RTU
Visual interface	Status LEDs
Measurement type	TRMS
Measurement frequency	1÷70 Hz
Sampling rate	6400 samples/s @50Hz 7280 samples/s @60Hz
Measurement update	Programmable Default: every 50 cycles (AC), max: 65535 cycles
Transformation ratio	CT and VT default 1,0; Programmable
Transformer phase-shift angle	Default 0,0° @50Hz; Programmable
Minimum display threshold	Adjustable on voltage, current and power
Voltage input	
Input impedance	400 kΩ
Rated capacity (U _n)	300 V _{LN}
Continuous overload (fault) (U _{MAX})	1,2 U _n
Overload for 500 ms	2 U _n
Current input	Non-isolated (CT required)
CT with current output	
Rated capacity (I _n)	5 A _{AC}
Crest factor	<4 (20 A _{PK} MAX)
Impedance	< 0,5 Ω
Continuous overload (I _{MAX})	6 A _{AC}
Overload for 500 ms	40 A _{AC}
CT with voltage output	
Rated capacity (V _n)	333 mV _{AC}
Crest factor	<3 (1 V _{PK} MAX)
Impedance	220 kΩ
Continuous overload (I _{MAX})	2,1 V _{PK}
Overload for 500 ms	13 V _{PK}
Precision (@ 25° C, 50 Hz)	
Voltage (U _n : 230/400 V)	±0,5% RDG (10÷100% U _n)
Current (I _n = 5 A)	±0,5% RDG (5÷100% I _n)
Frequency (40÷70 Hz)	±0,1 Hz
Power	ACTIVE: ±0,5% RDG REACTIVE: ±0,5% RDG



Energy	ACTIVE: Class C according to EN50470-1/3 or Class 0.5S according to EN62053-22 REACTIVE: Class 0.5S according to EN62053-24
Power factor	± (0,001 + 1% (1.00-PF))
Passaband (-3dB)	>2 kHz
Temperature coefficient	<100 ppm/°C

Available measurements



	Model	
	STANDARD	PLUS
I_{RMS} - V_{RMS} - I_{PK} - V_{PK}	✓	✓
Active Power (W), Reactive Power (VAR), Apparent Power (VA)	✓	✓
Bidirectional energy (kWh), positive and negative	✓	✓
Active and reactive energy (kVARh)	✓	✓
Power factor (inductive/capacitive), Crest factor	✓	✓
Frequency	✓	✓
CosΦ	✓	✓
TanΦ phase and average		✓
Average power factor		✓
Power factor distortion (inductive/capacitive)		✓
THD (V, I), TDD		✓
Min, med and max powers		✓
Internal temperature [°C]		✓
Inverter input (modulated PWM voltage)		✓
Time when active power P is above a certain threshold		✓
K-factor (according to IEEE Standard 1100-1992)		✓

Communication characteristics

RS485	Protocol	Modbus RTU
	Baudrate	1200÷ 115200 bps (default 9600)
	Addresses	1÷ 247 (default 1)
	Data format	1 start bit, 8-bit data, NO/ODD/EVEN parity (default NO parity)
	Response delay	1÷ 1000ms
	Connection	Via removable terminal, T-BUS or microUSB
Digital output	Can be activated by software as an alternative to the RS485 terminal	
	Usage	Alarm or pulse counter
	Type	Solid State (MOSFET)
	Limit values	<40V, <100mA

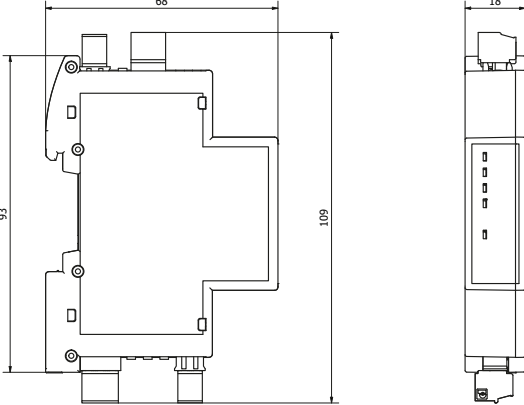

General data

Working temperature	-15÷60° C
Storage temperature	-40÷85° C
Relative humidity	10÷90% not condensing
Elevation	Up to 2000 m s.l.m.
Protection degree	IP20
Measurements	109x68x18mm 
Weight	60 g
Terminal cable cross-section	0.05÷1.5 mm ² (30÷14 AWG)
Energy values storage	Flash, minimum duration 1,000k writings
Appliance class	Cat. III (IEC 60664, EN60664)
Approvals and certifications	EN61000-6-3; EN61010-1 
Installation	DIN rail mounting

Order codes

Standard version	QE-POWER-M-STD
PLUS version	QE-POWER-M-PLUS
T-BUS	QA-TBUS-22



CONNECTION AND INSTALLATION

For the connection of several instruments with reduced wiring, the unit is designed for DIN rail mounting, with or without T-BUS connector. The functionality of the terminals is described below:

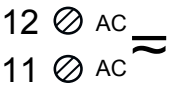
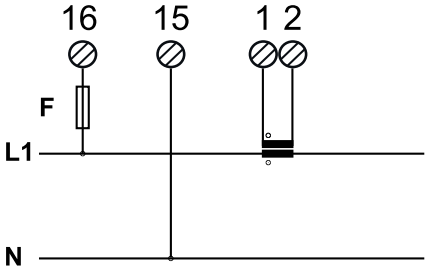
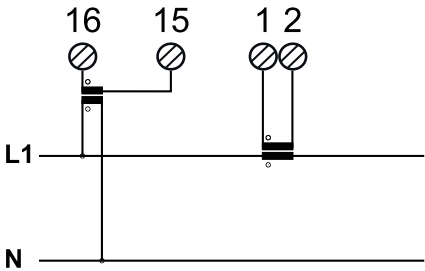
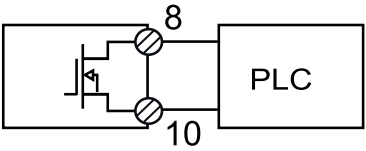
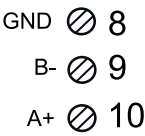
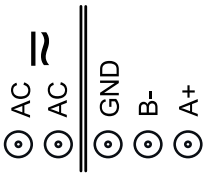
 <p>12 Ⓞ AC 11 Ⓞ AC</p>	<p>Device power supply Please note: Wiring must be protected against short circuits and/or accidental faults</p>
	<p>Single-phase 2-wire, 1 CT connection</p>
	<p>Single-phase 2-wire, 1 CT and 1 TV connection</p>
	<p>Digital output on removable terminal 8-9-10 configured in digital output mode</p>
<p>ModBus RTU</p>  <p>GND Ⓞ 8 B- Ⓞ 9 A+ Ⓞ 10</p>	<p>RS485 Modbus RTU connection: terminals 8, 9 (B-), 10 (A+)</p>
 <p>AC Ⓞ AC Ⓞ GND Ⓞ B- Ⓞ A+ Ⓞ</p>	<p>T-BUS connection (requires optional T-BUS accessory): the T-BUS accessory can be fitted to the module base to provide both power supply and serial communication (see figure below). The number of modules supported by the bus depends on the power supply used (please check the power consumption of the modules)</p>

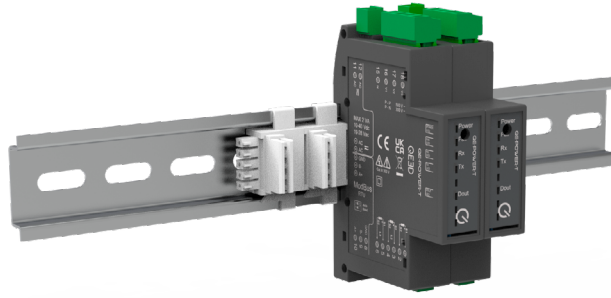

Figure 1: DIN-rail installation with T-BUS

RS485 BUS termination

To avoid unbalances on the transmission bus, it is advisable to insert a termination resistor at the beginning of the RS-485 bus (typically on the USB-RS485 adapter) and at the end (typically on the last slave - which can also be activated by dip-switch). It is advisable to use 120Ω resistors with 1% tolerance, which corresponds to the typical impedance of RS485 cables.

The following images are for illustrative purposes only:

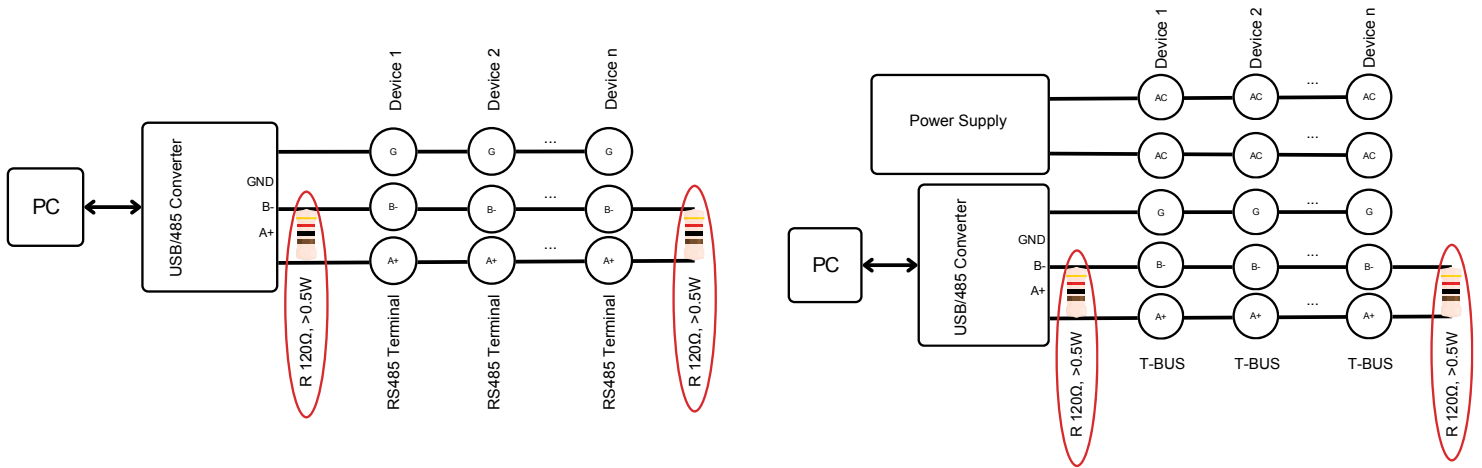

Figure 2: RS485 dynamic bus termination

STATUS LEDs

Function	Status	Meaning	
Power (green)	ON	Powered device	
Fail (yellow)	Flashing	Active bootloader: can be triggered by a Modbus RTU command or as a result of corruption of the program flash memory	
	ON	At least one of the following module states is present (configurable from Q-WIZARD or by accessing the dedicated registers - see page 16)	
		EEPROM fail	Settings, calibration or energy storing problems
		I o V over-range	Phase i of current or voltage has a value above the threshold
I o V under-range	Phase i of current or voltage has a value below the threshold		
RX (red)	Flashing	The system is receiving data from the RS485	
TX (red)	Flashing	The system is transmitting data on RS485	
Dout (green)	ON	Active digital output	



DIGITAL OUTPUT ALARM

To enable alarms via digital output, the RS485 terminal must be configured as a digital output. Communication is only possible via T-BUS.

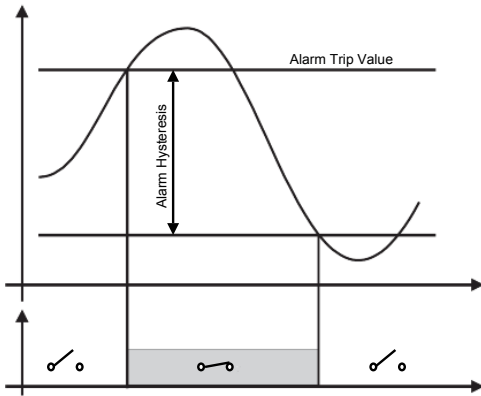

Figure 3: Upward: normally open contact

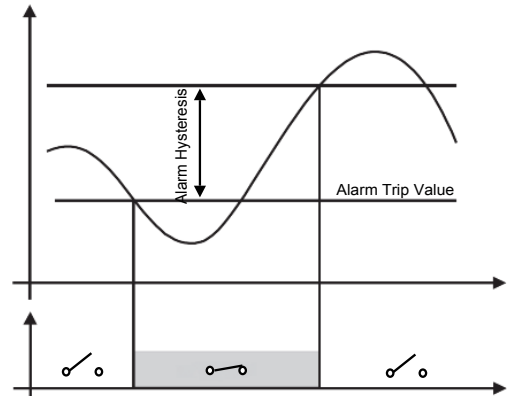

Figure 4: Downward: normally closed contact

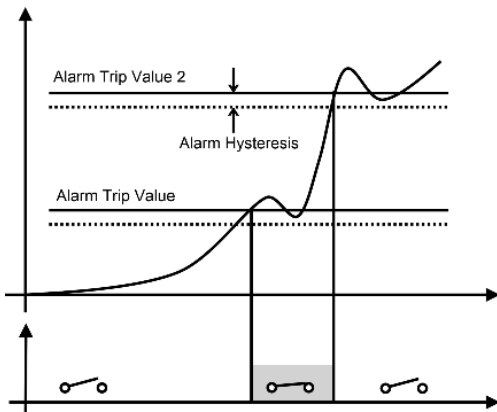

Figure 5: Windowed: closed contact between thresholds

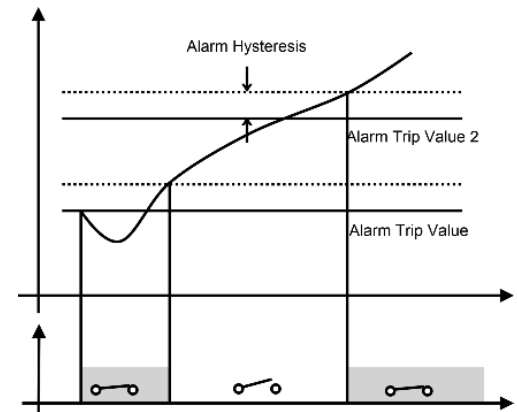

Figure 6: Windowed: closed contact outside the thresholds

ACCURACY (ACC. TO EN50470-3 AND EN62053-24)

The accuracy of the reactive power is guaranteed if the instrument is set to calculate Q using the Budeanu formula. (configurable from **Q-WIZARD** or by accessing the dedicated registers - see page 16)

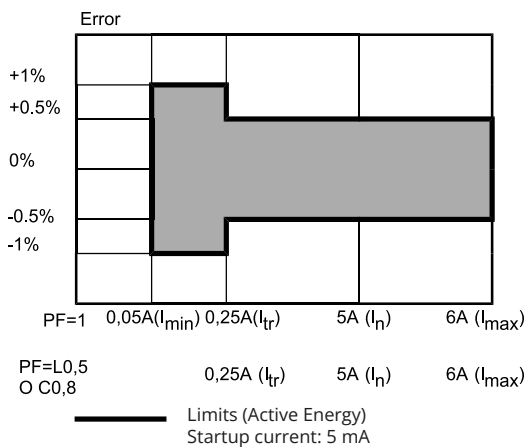

Figure 7: Wh, load-dependent accuracy (CT with current output)

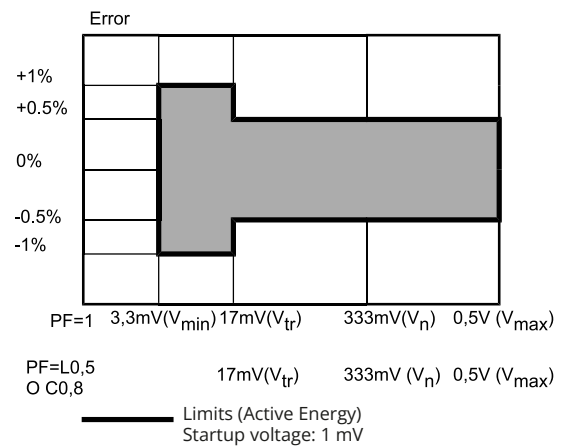

Figure 8: Wh, load-dependent accuracy (CT with voltage output)

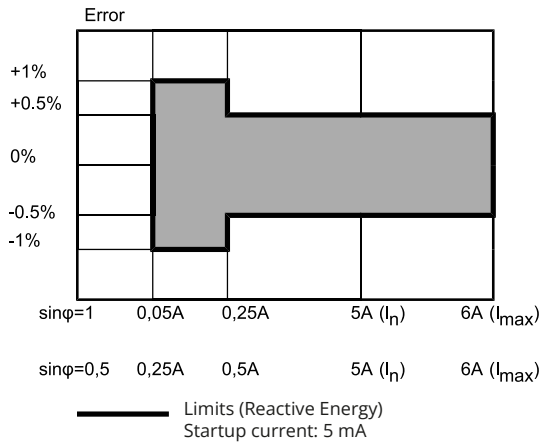

Figure 9: VARh, load-dependent accuracy (CT with current output)

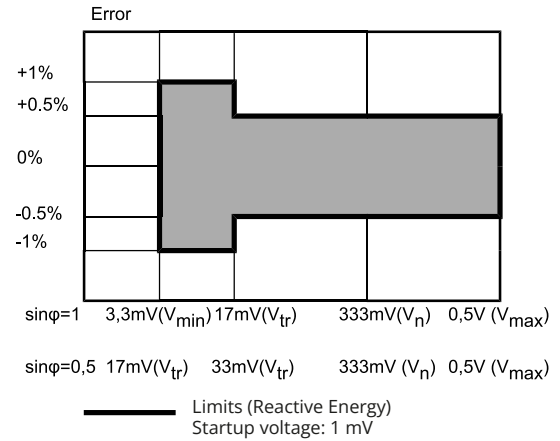

Figure 10: VARh, load-dependent accuracy (CT with voltage output)

PRODUCT FEATURES

Using the configuration software or acting on the dedicated registers, the following functions can be configured:

Modbus

Address, baud rate, parity and response delay can be set.

RTC (only PLUS version)

Inputs/outputs

- Enabling of energy flash storage [Reg. 40007]
- Energy display unit of measure [Reg. 40030]
- Energy Filtering [Reg. 40007]
- Time period for calculation of max., average and min. RMS values [Reg. 40027 - 40029]. [Reg. 40027 - 40029] (if set to 0, the value is not averaged and absolute values are taken for max. and min. values) (PLUS and PRO only)
- Window for max. demand and its threshold [Reg. 40025, 40043] (PLUS and PRO only)
- Filter on measurement [Reg. 40023 - 40024]
- Power calculation method [Reg. 40007]
- Current input type selection used [Reg. 40007] and related settings (transformer ratio [Reg. 40009], connection type [Reg.], FFT on absolute value or first harmonic [Reg. 40007])
- Voltage input type [Reg. 40007]
- Frequency calculation channel [Reg. 40007]
- Voltage input transformation ratio [Reg. 40013]
- Enable digital output instead of RS485 serial [Reg. 40007] (If DIP1 is set to 1, it will force the RTU terminals to work as RS485 and not as switch)

Status LEDs

By adjusting register [40008], it is possible to set a fault signal to be displayed via the Fail LED on the front of the device.

Digital alarm

By acting on registers [40026, 40035 - 40041], it is possible to define the alarms, the threshold and the hysteresis of the quantity that determines the activation of the alarm associated with the digital output. It is also possible to enter a delay on alarm signalling.



DEVICE CONFIGURATION

Dip-switch Modbus RTU address and baud rate setting

The baud rate can be changed using the DIP switch on one of the two sides of the module. If DIP1 is set to zero, the module adopts the configuration from the EEPROM, otherwise it adopts the configuration set by the DIP switch according to the table:

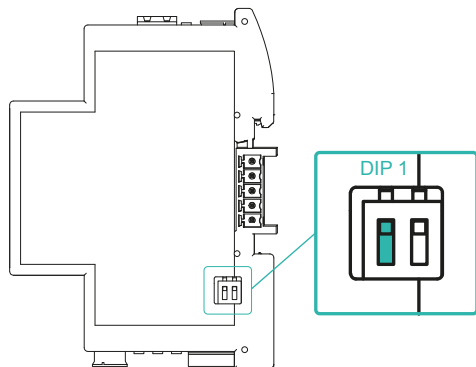

Figure 11: Baud rate configuration dip-switch

DIP1	DIP2	Address	Baudrate
0	x	EEPROM	EEPROM
1	0	1	9600
1	1	1	38400

Addresses other than 1 (default) or baud rates other than those shown in the table can be configured using the **Q-WIZARD configuration software** or the Modbus RTU functions below by acting on the dedicated registers (see page 16).

Functionality configuration

Through an RS485 serial device such as our Q-USB485, it is possible to connect to the product using the Modbus RTU input terminals.

The configuration of the module can be done with our **Q-WIZARD** configuration tool or with any third-party Modbus master, by acting on the registers of the card in the last chapter of this document (see page 16).

Q-WIZARD

Using the **Q-WIZARD interface tool (downloadable from here)**, all device parameters can be configured by following the simple, intuitive steps. In addition to the configuration of various parameters, inputs and outputs, the **Q-WIZARD** also allows real-time monitoring of device variables.

Third-party Modbus Master

Alternatively, the product can communicate directly with a third-party Modbus RTU Master using the communication settings according to the DIP switch configuration (when using microUSB the DIP switch settings are irrelevant).

The communication protocol supported is Modbus RTU Slave:

- Modbus RTU connections: A+ and B- according to Modbus RTU standards
- Supported Modbus RTU functions: 03 hexadecimal (read multiple registers, max 100), 06 hexadecimal (write single), 10 hexadecimal (write multiple registers)
- Modbus RTU address numbering is by convention '1 BASED' (standard), but the physical register is base 0; the logical address, e.g. 40010, corresponds to the physical address #9, as required by Modbus RTU standards

PLEASE NOTE: All setting changes of calibration and configuration parameters must be followed by the flash save command 0xC1C0 = Flash settings save command in register 40244; changes of device communication parameters in addition must also be followed by the command 0xC1A0 = Reboot command in register 40244.

In this case, all device configurations are performed by accessing the Modbus RTU register map available in the last chapter of this document using the functions:

- Read holding registers (function 03 hexadecimal)
- Write single holding register (function 06 hexadecimal)
- Write multiple registers (function 10 hexadecimal)



Function 03 Hexadecimal (Read Holding Registers)

This function is used to read the contents of a contiguous block of holding registers (words). The request frame specifies the source register address and the number of registers to read. A maximum of 120 registers (words) can be read with a single request, unless otherwise specified. The register data in the response message is packaged as two bytes per register (word), with the binary contents right-justified within each byte. For each register, the first byte contains the most significant bits (MSB) and the second byte contains the least significant bits (LSB).

Request Frame			
Description	Lenght	Value	Comments
Physical address	1 byte	1 to F7 HEX (1 to 247)	
Function code	1 byte	03 HEX	
Starting address	2 bytes	0000 to FFFF HEX	Bytes order: MSB, LSB
Number of registers (N word)	2 bytes	1 to 10 HEX (1 to 16)	Bytes order: MSB, LSB
CRC	2 bytes		

Response frame (right action)			
Description	Lenght	Value	Comments
Physical address	1 byte	1 to F7 HEX (1 to 247)	
Function code	1 byte	03 HEX	
Required Number of bytes	1 byte	N word * 2	
Register value	N*2 bytes		Bytes order: MSB, LSB
CRC	2 bytes		

Response frame (wrong action)			
Description	Lenght	Value	Comments
Physical address	1 byte	1 to F7 HEX (1 to 247)	Possible exception: 01: illegal function 02: illegal data address 03: Illegal data value 04: Slave device failure
Function code	1 byte	83 HEX	
Exception code	1 byte	01, 02, 03, 04 (see note)	
CRC	2 bytes		



Function 06 Hexadecimal (Write Single Holding Register)

This function is used to write a single holding register. The request frame specifies the address of the register (word) to be written and its contents. The correct response is an echo of the request, returned after the contents of the register have been written.

Request frame			
Description	Lenght	Value	Comments
Physical address	1 byte	1 to F7 HEX (1 to 247)	
Function code	1 byte	06 HEX	
Starting address	2 bytes	0000h to FFFF HEX	Bytes order: MSB, LSB
Register value	2 bytes	0000h to FFFF HEX	Bytes order: MSB, LSB
CRC	2 bytes		

Response frame (right action)			
Description	Lenght	Value	Comments
Physical address	1 byte	1 to F7 HEX (1 to 247)	
Function code	1 byte	06 HEX	
Starting address	2 bytes	0000h to FFFF HEX	Bytes order: MSB, LSB
Register value	2 bytes	0000h to FFFF HEX	Bytes order: MSB, LSB
CRC	2 bytes		

Response frame (wrong action)			
Description	Lenght	Value	Comments
Physical address	1 byte	1 to F7 HEX (1 to 247)	Possible exception: 01: illegal function 02: illegal data address 03: Illegal data value 04: Slave device failure
Function code	1 byte	86 HEX	
Exception code	1 byte	01, 02, 03, 04 (see note)	
CRC	2 bytes		



Function 10 Hexadecimal (Write Multiple Registers)

This function is used to write a block of contiguous registers (maximum of 2). The required values to be written are specified in the data field of the request. The data is packed as two bytes per register.

A correct response returns the function code, the starting address and the number of registers written.

Request frame			
Description	Lenght	Value	Comments
Physical address	1 byte	1 to F7 HEX (1 to 247)	
Function code	1 byte	10 HEX	
Starting address	2 bytes	0000 to FFFF HEX	Bytes order: MSB, LSB
Number of registers (N word)	2 bytes	0001 to 0078 HEX	Bytes order: MSB, LSB
Byte counting	1 byte	N word * 2	
Register value	N * 2 bytes	value	Bytes order: MSB, LSB
CRC	2 bytes		

Response frame (right action)			
Description	Lenght	Value	Comments
Physical address	1 byte	1 to F7 HEX (1 to 247)	
Function code	1 byte	10 HEX	
Starting address	2 bytes	0000 to FFFF HEX	Bytes order: MSB, LSB
Number of registers (N word)	2 bytes	0001 to 0078 HEX	Bytes order: MSB, LSB
CRC	2 bytes		

Response frame (wrong action)			
Description	Lenght	Value	Comments
Physical address	1 byte	1 to F7 HEX (1 to 247)	Possible exception: 01: illegal function 02: illegal data address 03: Illegal data value 04: Slave device failure
Function code	1 byte	90 HEX	
Exception code	1 byte	01, 02, 03, 04 (see note)	
CRC	2 bytes		



CONFIGURATION REGISTER 40007

This 16-bit register regulates the card's main operating settings. Below in detail:

Settings	Value	Detail
Input CT	xxxx xxxx xxxx xxx0	Current input (e.g. TA 5A)
	xxxx xxxx xxxx xxx1	Voltage input (e.g. TA 333 mV, Rogowski)
Calculation method for reactive power	xxxx xxxx xx0x xxxx	Triangular method: This method does not measure reactive power, but calculates it. It is the most commonly used method in energy meters.
	xxxx xxxx xx1x xxxx	Phase-shift method (Budeanu). This method measures reactive power. The accuracy values given are relative to this method.
Three-pole terminal 8-9-10 mode of use	xxxx xxxx x0xx xxxx	Used as RS485: 8 = GND, 9 = B-, 10 = A
	xxxx xxxx x1xx xxxx	Used as digital output between terminals 8 and 10. RS485 communication is still present on the T-Bus connector.
Frequency reading channel	xxxx xxxx 0xxx xxxx	Voltage channel
	xxxx xxxx 1xxx xxxx	Current channel
Voltage input type	xxxx xxx0 xxxx xxxx	Standard load
	xxxx xxx1 xxxx xxxx	PWM type input voltage
Energy data storage	xxxx xx0x xxxx xxxx	Storage disabled
	xxxx xx1x xxxx xxxx	Storage enabled
Dynamic data visualisation	xxx0 0xxx xxxx xxxx	Float
	xxx0 1xxx xxxx xxxx	Inverted Float
	xxx1 0xxx xxxx xxxx	Float hundredths
	xxx1 1xxx xxxx xxxx	Inverted Float hundredths
Integrator	xx0x xxxx xxxx xxxx	Integrator disabled
	xx1x xxxx xxxx xxxx	Integrator enabled for Rogowski input
Digital output behaviour	x0xx x0xx xxxx xxxx	Upward direction: contact normally open
	x1xx x0xx xxxx xxxx	Downward: contact normally closed
	x0xx x1xx xxxx xxxx	Windowed: contact closed between thresholds
	x1xx x1xx xxxx xxxx	Windowed: contact closed outside thresholds
Measurement filtering	0xxx xxxx xxxx xxxx	Disabled filtering: less stable measurements, but faster update
	1xxx xxxx xxxx xxxx	Enabled filtering: more stable measurements, but less rapid updating



REGISTER MAP

Default values are in **bold**.

ONLY PLUS VERSION

Register Name	Description	Register Type	R/W	Default	Address Modbus
Machine ID	36 = QE-POWER-M-STD 37 = QE-POWER-M-PLUS	UShort [16b]	R		40001
HW/FW version	Hardware (MSB) and Firmware (LSB) Revision	UShort [16b]	R		40002
Address	Modbus address	UShort [16b]	R/W	1	40003
Delay	Delay response expressed as cycles	UShort [16b]	R/W	1	40004
Baudrate	0 → 1200 1 → 2400 2 → 4800 3 → 9600 4 → 19200 5 → 38400 6 → 57600 7 → 115200	UShort [16b]	R/W	3	40005
Parity	0 → NONE 1 → ODD 2 → EVEN	UShort [16b]	R/W	0	40006
Configuration flag	Bit[0]: Current Measurement type 0 → Input 1A/5A 1 → Input 333 mV/ Rogowski Bit [3]: FFT representation 0 → Absolute 1 → Relative to the I1 value Bit[5]: Reactive power calculation method 0 → Triangle method 1 → Budeanu Bit[6]: RS485 as Switch (If DIP1 is ON the value will be forced to be 0 - RS-485) 0 → RS485 1 → Switch Bit[7]: Frequency detection Channel 0 → Voltage 1 → Current Bit[8]: Voltage input type 0 → Normal load 1 → PWM modulated input (Inverter Load) Bit[9]: Energy saving 0 → Disabled 1 → Enabled Bit[11...12]: Measurement type 0 → Float 1 → Float Swapped 2 → Hundredth (Float * 100) 3 → Hundredth swapped (Float * 100 SW) Bit[13]: Integrator condition 0 → Integrator disabled 1 → Integrator enabled (Rogowski input) Bit[10, 14]: Output switch initial condition 0 → Closed initial condition 1 → Windowed: closed contact between thresholds 2 → Open initial condition 3 → Windowed: closed contact outside thresholds Bit[15]: Filtered measurement 0 → Filtering disabled 1 → Filtering enabled	UShort [16b]	R/W	16928	40007
LED settings	Set Fail LED Bit: 0 → Fail Eeprom (settings, calibration or energy) 2 → I1 Over-range 3 → I1 Under-range 8 → V1 Over-range 9 → V1 Under-range	UShort [16b]	R/W	1	40008
TA Transducer ratio	If Input 1A/5A → Current transformer ratio M/N (Ex: 600:5 → transducer_ratio = 120) If Input Rogowski / 333mV → (1 / Sensitivity) [A/V] (Ex: 100mV/1KA → transducer_ratio = 10000, 333mV/5A → transducer_ratio = 15)	Float [32b-LSW]	R/W	1	40009
TA Transducer delay	Current transformer delay in [°] @ 50 Hz for accurate power calculation	Float [32b-LSW]	R/W	0	40011



Register Name	Description	Register Type	R/W	Default	Address Modbus
TV Transducer ratio	Voltage transformer ratio M/N - Default 1.0 (Ex: 1000:100 → transducer_ratio = 10)	Float [32b-LSW]	R/W	1	40013
TV Transducer delay	Voltage transformer delay in [°] @ 50 Hz for accurate power calculation	Float [32b-LSW]	R/W	0	40015
Minimum voltage ripple	Minimum threshold under which the instrument reads 0 independent from the input value	Float [32b-LSW]	R/W	0	40017
Minimum current ripple	Minimum threshold under which the instrument reads 0 independent from the input value	Float [32b-LSW]	R/W	0	40019
Minimum power ripple	Minimum threshold under which the instrument reads 0 independent from the input value (P, Q, and S)	Float [32b-LSW]	R/W	0	40021
DC Filter	Number of tenth seconds for I RMS value in DC	UShort [16b]	R/W	10	40023
AC Filter	Number of zero crossings for I RMS value in AC	UShort [16b]	R/W	50	40024
Minute for Max demand	Minute for Max demand calculation (0..45)	UShort [16b]	R/W	15	40025
seconds for mean RMS	Register in seconds (0..30) for RMS average	UShort [16b]	R/W	0	40027
seconds for MAX RMS	Seconds 1..30 for MAX RMS value. If the register is 0, then the absolute MAX RMS is given	UShort [16b]	R/W	0	40028
seconds for min RMS	Seconds 1..30 for min RMS value. If the register is 0, then the absolute min RMS is given	UShort [16b]	R/W	0	40029
Energy unit factor	Variable for changing Energy measurement unit: 0 -> [Wh/10] 1 -> [Wh] 4 -> [KWh]	UShort [16b]	R/W	0	40030
Alarm Register start address	Float value Starting address for alarm (40361 V_L1_N, ecc)	UShort [16b]	R/W	40361	40036
Alarm trip value	Alarm Threshold for "closed" and "open" condition OR first alarm Threshold for "within threshold" and "Outside threshold" condition	Float [32b-LSW]	R/W	0	40037
Alarm hysteresis	Alarm Hysteresis	Float [32b-LSW]	R/W	1	40039
Alarm trip value 2	Second alarm Threshold for "within threshold" and "Outside threshold" condition	Float [32b-LSW]	R/W		40041
Power Threshold for exceedings	Threshold for Power exceedings monitoring	Float [32b-LSW]	R/W	0	40043
Status	bit 0: flash settings error; bit 1: flash calibration error; bit 2: Current I1 Over Range; bit 3: Current I1 Under Range; bit 4..7: don't care; bit 8: Current V1 Over Range; bit 9: Current V1 Under Range; bit 10..14: don't care; bit 14: Zero crossing detecting; bit 15: Switch open; bit 16: Wh storing error; bit 17..18: don't care; bit 19: Alarm detection; bit 20..27: don't care; bit 28: Leading Power factor PF1; bit 29..30: don't care;	ULong [32b-LSW]	R		40239
Command	0xC1C0 = Flash settings save command 0xC1A0 = Reboot command 0xBABA = Save energy command 0xDAAA = Close Switch command (only if Digital Output is enabled) 0xDAAB = Open Switch command (only if Digital Output is enabled) 0xB000 = Enter Bootloader command 0xF000 = Reset MAX Demand registers command	ULong [32b-LSW]	R/W		40244
KWh	Active energy [Wh tenth]	Int [64b-LSW]	R/W		40245
KWh+	Positive Active energy [Wh tenth]	Int [64b-LSW]	R/W		40261
KWh-	Negative Active energy [Wh tenth]	Int [64b-LSW]	R/W		40277
KVARh	Reactive energy [VARh tenth]	Int [64b-LSW]	R/W		40293
KVARh Inductive	Inductive Reactive energy [VARh tenth]	Int [64b-LSW]	R/W		40309
KVARh Capacitive	Capacitive Reactive energy [VARh tenth]	Int [64b-LSW]	R/W		40325
KVAh	Apparent energy [VAh tenth]	Int [64b-LSW]	R/W		40341
Wh storage count	Number of Wh flash savings (every 20 seconds)	ULong [32b-LSW]	R		40357
V	RMS star voltage [V]	Float [32b-LSW]	R		40359
I	RMS line current [A]	Float [32b-LSW]	R		40375
P	RMS active power [W]	Float [32b-LSW]	R		40385
Q	RMS reactive power [VAR]	Float [32b-LSW]	R		40393
S	RMS apparent power [VA]	Float [32b-LSW]	R		40401
PF	Power Factor	Float [32b-LSW]	R		40409
CF	Crest Factor	Float [32b-LSW]	R		40417
Frequency	Frequency [Hz]	Float [32b-LSW]	R		40425
V peak	Star voltage peak [V]	Float [32b-LSW]	R/W		40427
I peak	current peak [A]	Float [32b-LSW]	R/W		40439



Register Name	Description	Register Type	R/W	Default	Address Modbus
DPF	Distortion Power Factor (+ inductive, - capacitive)	Float [32b-LSW]	R		40467
TAN(θ)	Tangentθ (+ inductive, - capacitive)	Float [32b-LSW]	R		40475
Internal temperature	Internal Temperature [°C]	Float [32b-LSW]	R		40485
V RMS AVG	Star voltage RMS average [V] over "seconds_for_mean_RMS"	Float [32b-LSW]	R		40487
V RMS MAX	Star voltage MAX RMS [V] over last "seconds_for_MAX_RMS"	Float [32b-LSW]	R		40489
V RMS min	Star voltage Min RMS [V] over last "seconds_for_min_RMS"	Float [32b-LSW]	R		40491
IRMS AVG	RMS average [A] over "seconds_for_mean_RMS"	Float [32b-LSW]	R		40535
IRMS MAX	MAX RMS [A] over last "seconds_for_MAX_RMS"	Float [32b-LSW]	R		40537
IRMS min	Min RMS [A] over last "seconds_for_min_RMS"	Float [32b-LSW]	R		40539
P RMS AVG	P RMS average [A] over "seconds_for_mean_RMS"	Float [32b-LSW]	R		40565
P RMS MAX	P MAX RMS [A] over last "seconds_for_MAX_RMS"	Float [32b-LSW]	R		40567
P RMS min	P Min RMS [A] over last "seconds_for_min_RMS"	Float [32b-LSW]	R		40569
Q RMS AVG	Q RMS average [A] over "seconds_for_mean_RMS"	Float [32b-LSW]	R		40589
Q RMS MAX	Q MAX RMS [A] over last "seconds_for_MAX_RMS"	Float [32b-LSW]	R		40591
Q RMS min	Q Min RMS [A] over last "seconds_for_min_RMS"	Float [32b-LSW]	R		40593
S RMS AVG	S RMS average [A] over "seconds_for_mean_RMS"	Float [32b-LSW]	R		40613
S RMS MAX	S MAX RMS [A] over last "seconds_for_MAX_RMS"	Float [32b-LSW]	R		40615
S RMS min	S Min RMS [A] over last "seconds_for_min_RMS"	Float [32b-LSW]	R		40617
PF RMS AVG	PF RMS average [A] over "seconds_for_mean_RMS"	Float [32b-LSW]	R		40637
PF RMS MAX	PF MAX RMS [A] over last "seconds_for_MAX_RMS"	Float [32b-LSW]	R		40639
PF RMS min	PF Min RMS [A] over last "seconds_for_min_RMS"	Float [32b-LSW]	R		40641
P Time over threshold	Time above threshold specified in "Power_Threshold_for_exceedings" for Active Power P [min]	Float [32b-LSW]	R		40661
P Max Demand	Max Demand over "minute_for_Max_demand" for P for current month	Float [32b-LSW]	R		40669
Time of P MaxDemand	Time at which arises Max Demand over "minute_for_Max_demand" for P for current month (month day hour minutes)	ULong [32b-LSW]	R		40677
K factor	K-factor for I, see IEEE Standard 1100-1992	Float [32b-LSW]	R		40685
Year	RTC: year (2000-2099)	UShort [16b]	R/W		40691
Month	RTC: month (1-12)	UShort [16b]	R/W		40692
Day	RTC: day month (1-31)	UShort [16b]	R/W		40693
Hour	RTC: hour (0-23)	UShort [16b]	R/W		40694
Minute	RTC: minute (0-59)	UShort [16b]	R/W		40695
Seconds	RTC: second (0-59)	UShort [16b]	R/W		40696
THD V	THD Star Voltage	Float [32b-LSW]	R		40697
THD I	THD Line Current	Float [32b-LSW]	R		40709
TDD I	TDD Line Current	Float [32b-LSW]	R		40717

LEGEND:

Short [16b] = Signed Short (16 bit)
UShort [16b] = Unsigned Short (16 bit)

Long [32b-MSW] = Signed Long (32 bit - MSW First Register)
Long [32b-LWS] = Signed Long (32 bit - LSW First Register)
ULong [32b-LSW] = Unsigned Long (32 bit - LSW First Register)
ULong [32b] = Unsigned Long (32 bit)

Float [32b-MSW] = Float (32 bit - MSW First Register)
Float [32b-LSW] = Float (32 bit - LSW First Register)

UInt [16b] = Unsigned Integer (16 bit)
UInt [32b-MSW] = Unsigned Integer (32 bit - MSW First Register)
Int [64b-LSW] = Signed Long Long (64 bit - LSW First Register)