

QE-POWER-T



PATENTED



Visit the **QE-POWER-T** page
for news, updates and downloads



CONTENTS

Product overview	3	Status LEDs	11
Product specifications	3	Digital alarm	11
Technical specifications	4	Energy quality (only PRO version)	11
Electrical characteristics	4	Device configuration	12
Available measurements	5	Dip-switch Modbus RTU address and baud rate setting	12
Communication characteristics	5	Functionality configuration	12
General data	6	Q-WIZARD	12
Order codes	6	Third-party Modbus Master	12
Connection and installation	7	Function 03 Hexadecimal (Read Holding Registers)	13
RS485 bus termination	9	Function 06 Hexadecimal (Write Single Holding Register)	13
Status LEDs	9	Function 10 Hexadecimal (Write Multiple Registers)	14
Digital output alarm	10	Configuration register 40007	15
Accuracy (acc. to EN50470-3 and EN62053-24)	10	Register map	16
Product features	11		
Modbus	11		
RTC (only PLUS and PRO versions)	11		
Inputs/outputs	11		



SAFETY WARNINGS AND CAUTIONS

The following warnings and cautions must be observed to ensure personal safety and prevent damage.



Death or **serious injury** may result from failure to heed this warning.



It is necessary to comply with national regulations when installing and picking materials for power lines.



Material damage or **serious personal injury** may result from failure to heed this warning.



Repairs and modifications must be carried out only by the manufacturer. It is forbidden to open the case and make any changes to the device. Tampering with the device will invalidate the warranty.



The manufacturer **declines all responsibility** for electrical safety in the event of improper use of the equipment.



ATTENTION: Class II object, in accordance with the standard 'EN 61140:2004-05 "Protection against electrical contacts - Common aspects for installations and equipment - Equipotential bonding", **grounding of the instrument is prohibited** as this would damage the device and reduce the safety of the installation.



The product described in this document may only be used for the specified application. The maximum performance data and environmental conditions specified in the product data sheet must be observed. Proper transport and storage, as well as professional assembly, installation, handling and maintenance are required for the correct and safe operation of the device.



It is essential to read the entire contents of this manual before carrying out any work.

Use under ambient conditions other than those specified, application of signals or voltages other than those specified, may cause significant deviations from the specified measurement tolerances, which may be irreversible.

Installation and commissioning must be carried out by qualified personnel only.



Before commissioning, make sure that:

- the maximum values for all connections are not exceeded; refer to the product data sheet;
- the connection cables are not damaged or live during wiring;
- the direction of current flow and phase rotation are correct.

During installation, ensure that a switch or circuit-breaker is near the product and easily accessible.

The unit must be uninstalled if safe operation can no longer be guaranteed (e.g. visible damage). Disconnect all connections in this case. The unit should be returned to the manufacturer or to an authorised service centre for repair.



Although the contents of this document have been checked for accuracy, it may contain errors or inconsistencies and we cannot guarantee its completeness or accuracy.



This document is subject to periodic revision and updating. QEED reserves the right to make changes to the product and/or its technical documentation at any time in the interests of continuous quality improvement. Always consult the latest version of the documentation available on the website:

www.qeed.it

If you find any errors or missing information in this document, please notify us by e-mail to:

technical@qeed.it



WARNING: High-intensity magnetic fields may alter the values measured by the transformer. Avoid installation near: permanent magnets, electromagnets, or iron masses. If irregularities are detected, reposition or move the unit to a more suitable location.



Disposal of waste electrical and electronic equipment (applicable in the European Union and other countries with separate collection). The symbol on the product or its packaging indicates that the product should not be treated as household waste. Instead, it will be handed over to an authorised collection point for the recycling of electrical and electronic waste. Ensuring that the product is disposed of properly will prevent potential negative effects on the environment and human health, which could otherwise be caused by inappropriate waste management of the product. Recycling materials helps to conserve natural resources. For further information, please contact your local authority, waste disposal service or the retailer from whom you purchased the product.



Failure to observe the warnings may result in damage to the equipment or failure to operate as intended.



Please note that the information on the nameplate must be observed.



PRODUCT OVERVIEW

The QE-POWER-T is a three-phase AC power analyser (1 DIN case) with a universal input for current transformers that can accept any type of current sensor (with voltage output 0÷333mV or current 1A/5A and Rogowski probes), available in 3 versions with different measurements.

It complies with class 0.5S (kWh) of EN62053-22 and class 0.5S (kVARh) of EN62053-24 and has an accuracy of $\pm 0.5\%$ RDG. The QE-POWER-T is capable of TRMS (voltage/current) measurements.

A digital contact (MOSFET), configurable as a pulse or alarm output, is available as an alternative to the RS485 terminal.

Power/error/communication/output status LEDs are on the front of the case.

RS485 serial interface for communication with Modbus RTU protocol, either from the **Q-WIZARD configuration tool**, or with third party Modbus masters by acting on register map registers.

Ready for DIN rail mounting with T-BUS terminal (optional) for fast connection with hot insertion/removal option.

Product specifications

- Bidirectional energy measurement
- Complies with class 0.5S (kWh) of EN62053-22
- Complies with class 0.5S (kVARh) of EN62053-24
- Accuracy $\pm 0.5\%$ RDG
- Current meter inputs for transformers with secondary (1A/5A, 0...333mV, Rogowski probes)
- TRMS measurement (voltage/current)
- One pulse output (MOSFET) for alarms (alternative to RS485 output on terminals)
- RS485 serial interface to terminals or T-BUS
- Alarm indication via front LED
- Available in 3 versions: STD, PLUS and PRO

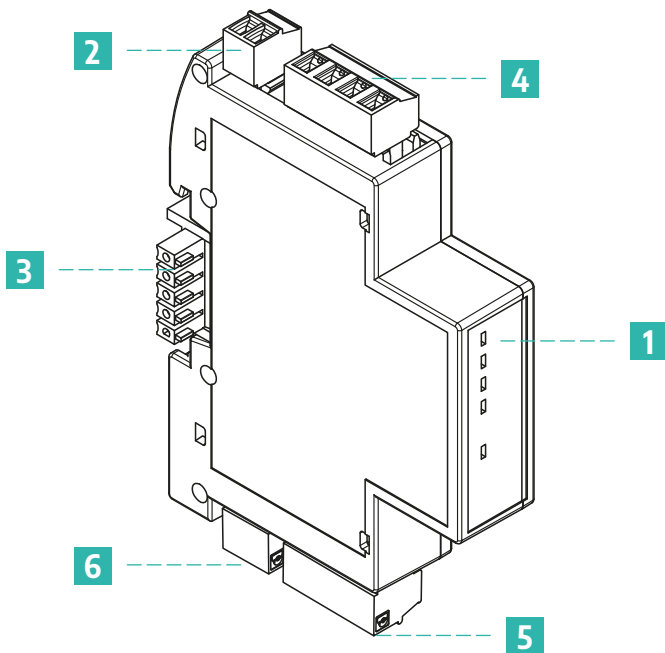

- 1 Status LEDs
- 2 Power supply terminals
- 3 T-BUS terminal for both power supply and Modbus RTU communication (optional)
- 4 Voltage inputs
- 5 Current inputs
- 6 Modbus RTU terminals



TECHNICAL SPECIFICATIONS

Electrical characteristics

Power supply	10÷40 V _{DC} or 20÷28 V _{AC} @ 50/60Hz
Current consumption	1,2 W max
Isolation	4 kV _{RMS} between power supply and measurement inputs 4 kV _{RMS} between RS485 and measurement inputs 1,5 kV _{RMS} between power supply and RS485
Voltage inputs	Direct connection up to 500 V _{RMS} maximum (40÷70 Hz) Transformation ratio for voltage and current transformers (configurable from Q-WIZARD or registers)
Current inputs	1 A / 5 A 0÷ 333 mV
Output	SPST MOSFET dry digital contact (<40V, <100mA)
Communication interface	RS485 Modbus RTU
Visual interface	Status LEDs
Measurement type	TRMS
Measurement frequency	1÷70 Hz
Sampling time	6400 samples/s @ 50 Hz 7280 samples/s @ 60 Hz
Measurement update	Programmable Default: every 50 cycles (AC), max: 65535 cycles
Transformation ratio	CT and VT default 1,0; Programmable
Transformer phase-shift angle	Default 0,0° @50Hz; Programmable
Minimum display threshold	Adjustable on voltage, current and power
Voltage input	
Input impedance	400 kΩ
Rated capacity U _n	300 V _{LN} - 500 V _{LL}
Continuous overload fault U _{MAX}	1,2 U _n
Overload for 500 ms	2 U _n
Current input	Non-isolated (CT required)
CT with current output	
Rated capacity I _n	5A _{AC}
Crest factor	<4 (20 A _{PK} MAX)
Impedance	< 0,5 Ω
Continuous overload I _{MAX}	6 A _{AC}
Overload for 500 ms	40 A _{AC}
CT with voltage output	
Rated capacity V _n	333 mV _{AC}
Crest factor	<3 (1 V _{PK} MAX)
Impedance	220 kΩ
Continuous overload I _{MAX}	2,1 V _{PK}
Overload for 500 ms	13 V _{PK}
Precision (@25°C, 50Hz)	
Voltage (U _n : 230/400 V)	±0,5% RDG (10÷100% U _n)
Current (I _n = 5 A)	±0,5% RDG (5÷100% I _n)
Frequency (40÷70 Hz)	±0,1 Hz
Power	ACTIVE: ±0,5% RDG REACTIVE: ±0,5% RDG



Energy	ACTIVE: Class C according to EN50470-1/3 or Class 0.5S according to EN62053-22 REACTIVE: Class 0.5S according to EN62053-24
Power factor	$\pm (0,001 + 1\% (1,00-PF))$
Passaband (-3dB)	>2 kHz
Temperature coefficient	<100 ppm/°C

Available measurements



	Model		
	STANDARD	PLUS	PRO
I _{rms} - V _{rms} - I _{pk} - V _{pk} each phase	✓	✓	✓
Active Power (W), Reactive Power (VAR), Apparent Power (VA) per phase	✓	✓	✓
Bidirectional energy (kWh), positive and negative, per phase and total	✓	✓	✓
Active and reactive energy (kVARh), inductive/capacitive, per phase and total	✓	✓	✓
Power factor (inductive/capacitive) per phase and total	✓	✓	✓
Crest factor per phase and total	✓	✓	✓
Frequency	✓	✓	✓
Step sequence control	✓	✓	✓
Cosφ per phase and average	✓	✓	✓
Tanφ for phase and average		✓	✓
Min, med and max power factor for phase and medium		✓	✓
Power factor distortion (inductive/capacitive) per phase and medium		✓	✓
THD (V, I), TDD		✓	✓
Min, med and max Powers		✓	✓
Peak power demand, per phase and total		✓	✓
Recording (monthly) of reaching the maximum power demand (month, day, hour, minute), per phase and total		✓	✓
Adjustable time above threshold, per phase and total		✓	✓
K-factor (according to IEEE Standard 1100-1992)		✓	✓
Internal temperature [°C]		✓	✓
Harmonic analysis up to 63rd			✓
Interharmonic analysis up to 63rd			✓
SAG, SWELL, Voltage gaps			✓

Communication characteristics

RS485	Protocol	Modbus RTU
	Baudrate	1200 ÷ 115200 bps (default 9600)
	Addresses	1÷ 247 (default 1)
	Data format	1 start bit, 8-bit data, NO/ODD/EVEN parity (default NO parity)
	Response delay	1÷ 1000ms
	Connection	Via removable terminal, T-BUS or microUSB
Digital output	Can be activated by software as an alternative to the RS485 terminal	
	Usage	Alarm or pulse counter
	Type	Solid State (MOSFET)
	Limit values	<40V, <100mA

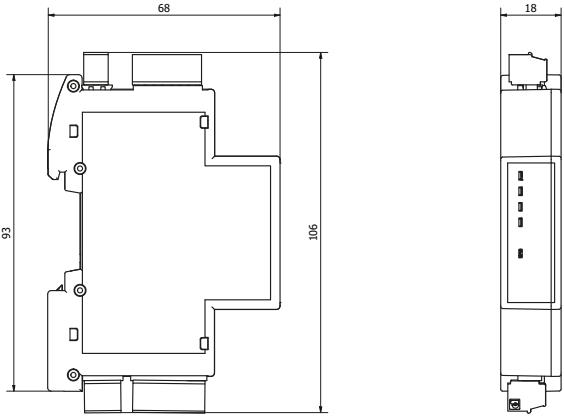

General data

Working temperature	-15÷60° C
Storage temperature	-40÷85° C
Relative humidity	10÷90% not condensing
Elevation	Up to 2000m a.s.l.
Protection degree	IP20
Measurements	106x68x18 mm 
Weight	60 g
Terminal cable cross-section	0.05÷1.5 mm ² (30÷14 AWG)
Energy values storage	Flash, min. 1000k writings
Appliance class	Cat. III (IEC 60664, EN60664)
Approvals and certifications	EN61000-6-3; EN61010-1 
Installation	DIN rail mounting

Order codes

Standard version	QE-POWER-T-STD
PLUS version	QE-POWER-T-PLUS
PRO version	QE-POWER-T-PRO
T-BUS	QA-TBUS-22



CONNECTION AND INSTALLATION

For the connection of several instruments with reduced wiring, the unit is designed for DIN rail mounting, with or without T-BUS connector. The functionality of the terminals is described below:

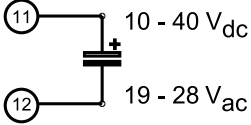
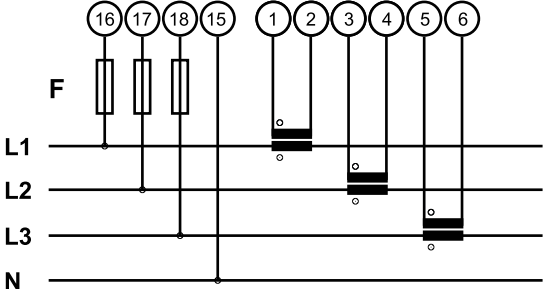
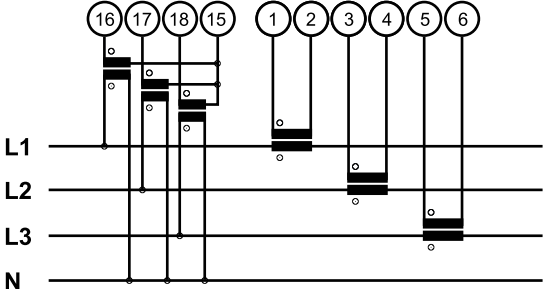
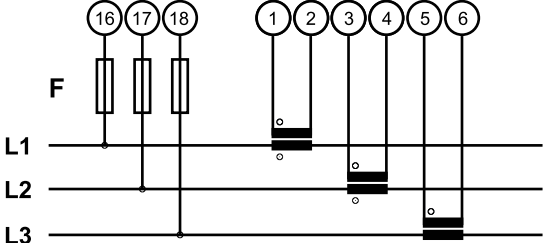
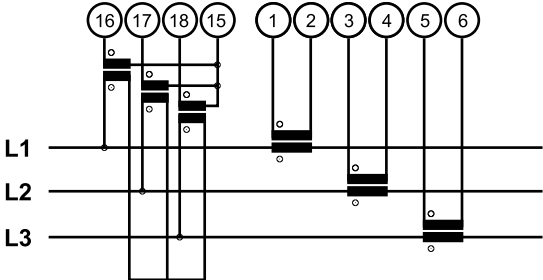
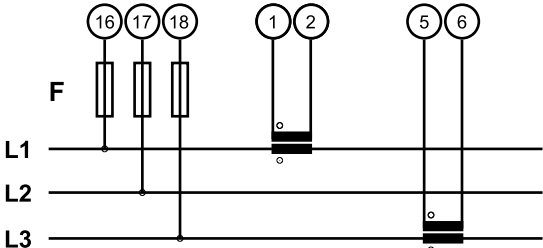
	<p>Device power supply PLEASE NOTE: Wiring must be protected against short circuits and/or accidental faults</p>
	<p>3-phase, 4-wire, 3 CT connection</p>
	<p>3-phase, 4-wire, 3 CT and 3 TV connection</p>
	<p>3-phase, 3-wire, 3 CT connection</p>
	<p>3-phase, 3-wire, 3 CT and 3 TV connection</p>
	<p>3-phase, 3-wire, 2 CT connection (Aron)</p>



	<p>3-phase, 3-wire, connection with 2 CTs and 3 TVs (Aron)</p>
	<p>Single-phase, 2-wire, 1 CT connection</p>
	<p>Single-phase, 2-wire, connection with 1 CT and 1 TV</p>
	<p>Digital output on withdrawable terminal 8-9-10 configured in digital output mode</p>
<p>ModBus RTU</p> <p>GND 8</p> <p>B- 9</p> <p>A+ 10</p>	<p>RS485 Modbus RTU connection: terminals 8, 9 (B-), 10 (A+)</p>
	<p>T-BUS connection (requires optional T-BUS accessory): the T-BUS accessory can be fitted to the module base to provide both power supply and serial communication (see figure below). The number of modules supported by the bus depends on the power supply used (please check the power consumption of the modules)</p>



Figure 1: DIN-rail installation with T-BUS

RS485 bus termination

To avoid unbalances on the transmission bus, it is advisable to insert a termination resistor at the beginning of the RS-485 bus (typically on the USB-RS485 adapter) and at the end (typically on the last slave - which can also be activated by dip-switch). It is advisable to use 120Ω resistors with 1% tolerance, which corresponds to the typical impedance of RS485 cables.

The following images are for illustrative purposes only:

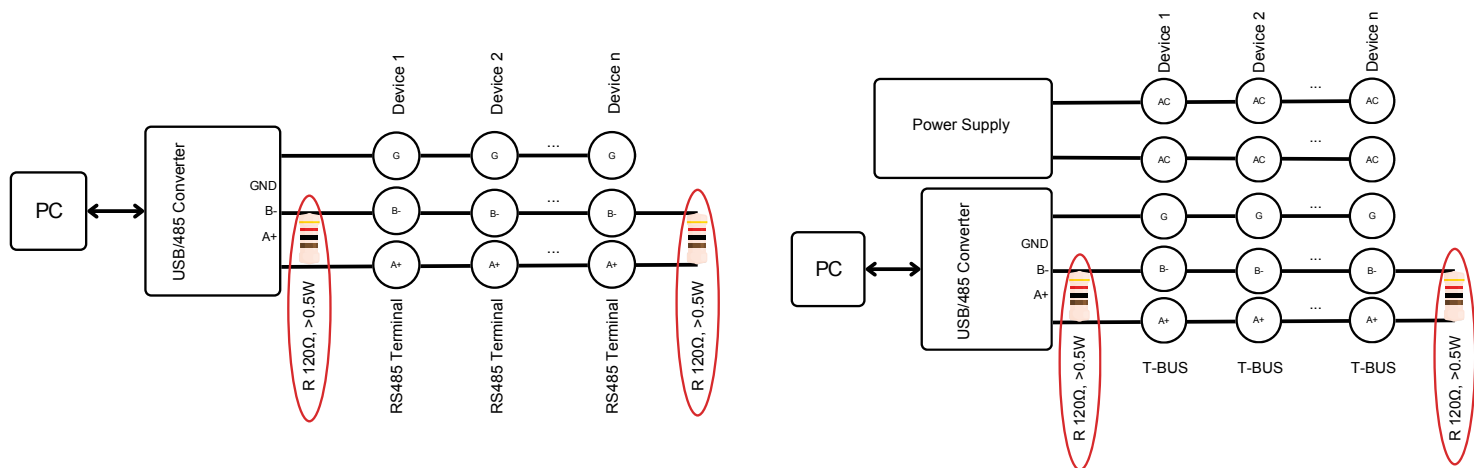

Figure 2: RS485 dynamic bus termination

STATUS LEDs

Function	Status	Meaning		
Power (green)	ON	Powered device		
Fail (yellow)	ON	Flashing	Active bootloader: can be triggered by a Modbus RTU command or as a result of corruption of the program flash memory	
		ON	At least one of the following module states is present (configurable from Q-WIZARD or by accessing the dedicated registers - see page 16)	
			EEPROM fail	Settings, calibration or energy storing problems
			Phase reversal	The order of phases L1, L2 and L3 is not correct.
			Io V over-range	phase i of current or voltage has a value above the threshold
		Io V under-range	phase i of current or voltage has a value below the threshold	
RX (red)	Flashing	The system is receiving data from the RS485		
TX (red)	Flashing	The system is transmitting data on RS485		
Dout (green)	ON	Active digital output		



DIGITAL OUTPUT ALARM

To enable alarms via digital output, the RS485 terminal must be configured as a digital output. Communication is only possible via T-BUS.

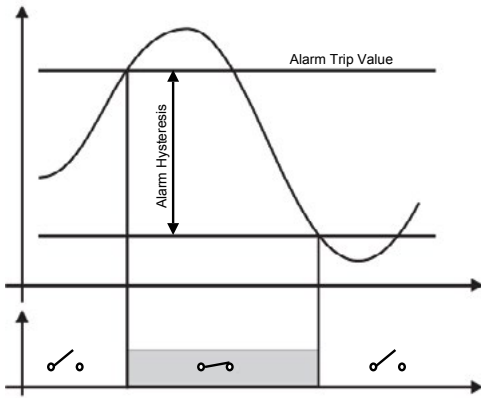

Figure 3: Upward: normally open contact

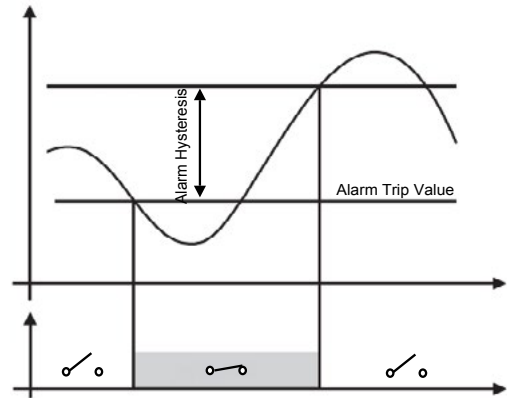

Figure 4: Downward: normally closed contact

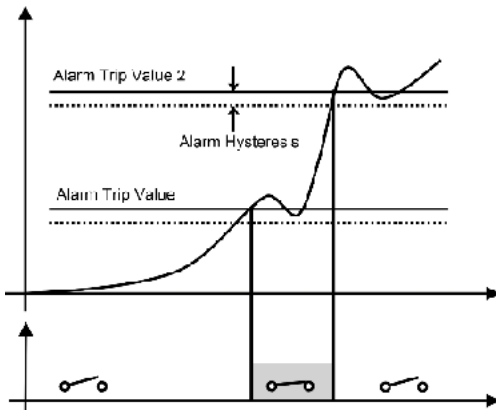

Figure 5: Windowed: closed contact between thresholds

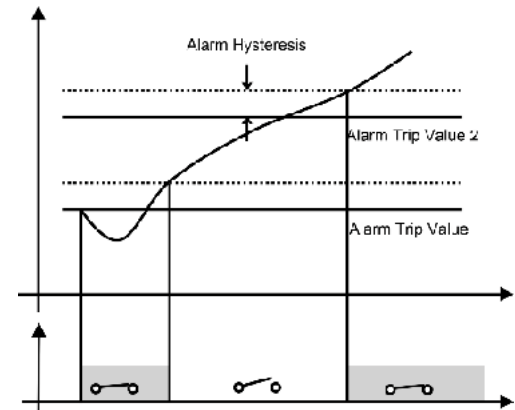

Figure 6: Windowed: closed contact outside the thresholds

ACCURACY (ACC. TO EN50470-3 AND EN62053-24)

The accuracy of the reactive power is guaranteed if the instrument is set to calculate Q using the Budeanu formula (configurable from **Q-WIZARD** or by accessing the dedicated registers - see page 16).

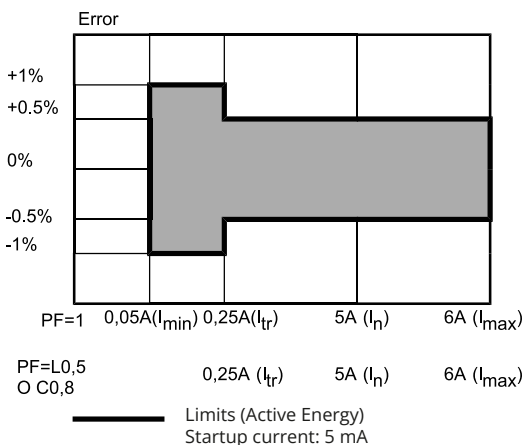

Figure 7: Wh, load-dependent accuracy (CT with current output)

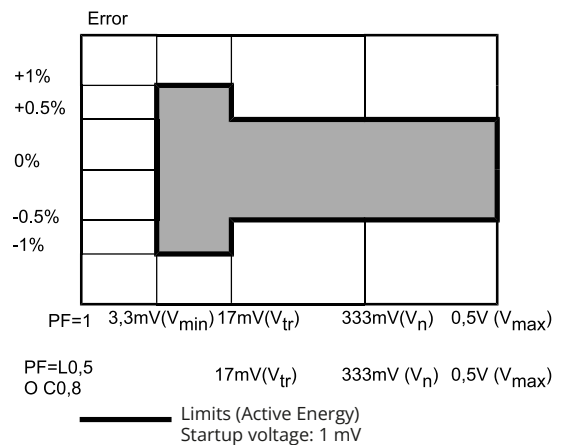

Figure 8: Wh, load-dependent accuracy (CT with voltage output)

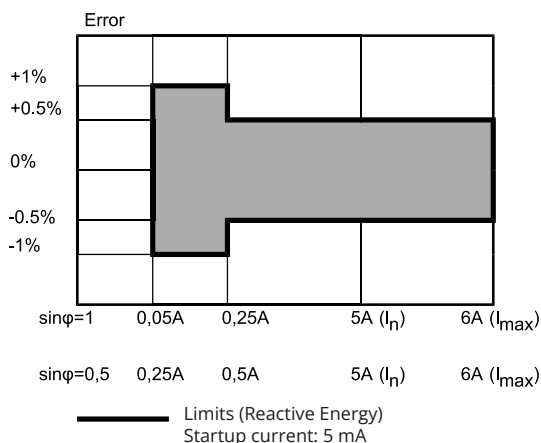

Figure 9: VARh, load-dependent accuracy (CT with current output)

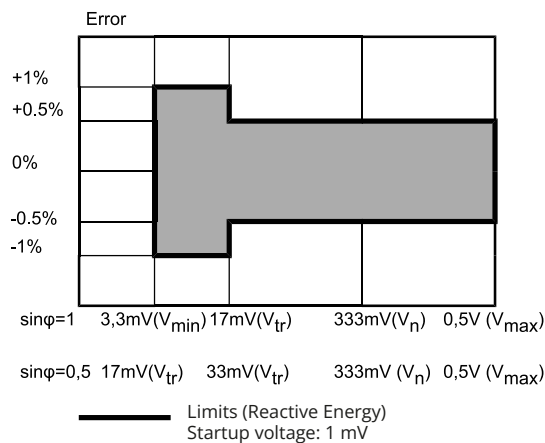

Figure 10: VARh, load-dependent accuracy (CT with voltage output)

PRODUCT FEATURES

Using the configuration software or acting on the dedicated registers, the following functions can be configured:

Modbus

Address, baud rate, parity and response delay can be set.

RTC (only PLUS and PRO versions)

Inputs/outputs

- Enabling of energy flash storage [Reg. 40007]
- Energy display unit of measure [Reg. 40030]
- Energy Filtering [Reg. 40007]
- Time period for calculation of max., average and min. RMS values [Reg. 40027 - 40029]. [Reg. 40027 - 40029] (if set to 0, the value is not averaged and absolute values are taken for max. and min. values) (PLUS and PRO only)
- Window for max. demand and its threshold [Reg. 40025, 40043] (PLUS and PRO only)
- Filter on measurement [Reg. 40023 - 40024]
- Power calculation method [Reg. 40007]
- Current input type selection used [Reg. 40007] and related settings (transformer ratio [Reg. 40009], connection type [Reg.], FFT on absolute value or first harmonic [Reg. 40007])
- Voltage input type [Reg. 40007]
- Frequency calculation channel [Reg. 40007]
- Voltage input transformation ratio [Reg. 40013]
- Enable digital output instead of RS485 serial [Reg. 40007] (If DIP1 is set to 1, it will force serial 485 as RS-485 and not switch)

Status LEDs

By adjusting register [40008], it is possible to set a fault signal to be displayed via the Fail LED on the front of the device.

Digital alarm

Acting on register [40026] it is possible to select the type of alarm (single or multiple). In the case of a single alarm from register [40035 - 40041], it is possible to set the threshold and hysteresis of the quantity that determines the activation of the alarm associated with the digital output. It is also possible to enter a delay on alarm signalling.

Energy quality (only PRO version)

By acting on registers [Reg. 40045 - 40053], threshold values for 'interruption, under-voltage and over-voltage' (Interruption, SAG and SWELL) can be set.



DEVICE CONFIGURATION

Dip-switch Modbus RTU address and baud rate setting

The baud rate can be changed using the DIP switch on one of the two sides of the module. If DIP1 is set to zero, the module adopts the configuration from the EEPROM, otherwise it adopts the configuration set by the DIP switch according to the table:

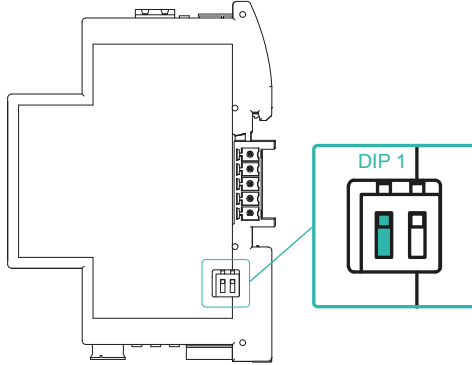

Figure 11: Baud rate configuration dip-switch

DIP1	DIP2	Address	Baudrate
0	x	EEPROM	EEPROM
1	0	1	9600
1	1	1	38400

Addresses other than 1 (default) or baud rates other than those shown in the table can be configured using the **Q-WIZARD** configuration software or the Modbus RTU functions below by acting on the dedicated registers - see page 16.

Functionality configuration

It is possible to connect to the product via an RS485 serial device, such as our Q-USB485, or via the microUSB port.

The configuration of the module can be done with **Q-WIZARD** configuration software or the Modbus RTU functions below by acting on the dedicated registers - see page 16.

Q-WIZARD

Using the **Q-WIZARD interface tool** all device parameters can be configured by following the simple, intuitive steps.

In addition to the configuration of various parameters, inputs and outputs, the **Q-WIZARD** also allows real-time monitoring of device variables.

Third-party Modbus Master

Alternatively, the product can communicate directly with a third-party Modbus RTU Master using the communication settings according to the DIP switch configuration (when using microUSB the DIP switch settings are irrelevant).

The communication protocol supported is Modbus RTU Slave:

- Modbus RTU connections: A+ and B- according to Modbus RTU standards
- Supported Modbus RTU functions: 03 hexadecimal (read multiple registers, max 100), 06 hexadecimal (write single), 10 hexadecimal (write multiple registers)
- Modbus RTU address numbering is by convention '1 BASED' (standard), but the physical register is base 0; the logical address, e.g. 40010, corresponds to the physical address #9, as required by Modbus RTU standards

PLEASE NOTE: All setting changes of calibration and configuration parameters must be followed by the flash save command 0xC1C0 = Flash settings save command in register 40244; changes of device communication parameters in addition must also be followed by the command 0xC1A0 = Reboot command in register 40244.

In this case, all device configurations are performed by accessing the Modbus RTU register map available in the last chapter of this document using the functions:

- Read holding registers (function 03 hexadecimal)
- Write single holding register (function 06 hexadecimal)
- Write multiple registers (function 10 hexadecimal)



Function 03 Hexadecimal (Read Holding Registers)

This function is used to read the contents of a contiguous block of holding registers (words). The request frame specifies the source register address and the number of registers to read. A maximum of 120 registers (words) can be read with a single request, unless otherwise specified. The register data in the response message is packaged as two bytes per register (word), with the binary contents right-justified within each byte. For each register, the first byte contains the most significant bits (MSB) and the second byte contains the least significant bits (LSB).

Request Frame			
Description	Lenght	Value	Comments
Physical address	1 byte	1 to F7 HEX (1 to 247)	
Function code	1 byte	03 HEX	
Starting address	2 bytes	0000 to FFFF HEX	Bytes order: MSB, LSB
Number of registers (N word)	2 bytes	1 to 10 HEX (1 to 16)	Bytes order: MSB, LSB
CRC	2 bytes		

Response frame (right action)			
Description	Lenght	Value	Comments
Physical address	1 byte	1 to F7 HEX (1 to 247)	
Function code	1 byte	03 HEX	
Required Number of bytes	1 byte	N word * 2	
Register value	N*2 bytes		Bytes order: MSB, LSB
CRC	2 bytes		

Response frame (wrong action)			
Description	Lenght	Value	Comments
Physical address	1 byte	1 to F7 HEX (1 to 247)	Possible exception: 01: illegal function 02: illegal data address 03: Illegal data value 04: Slave device failure
Function code	1 byte	83 HEX	
Exception code	1 byte	01, 02, 03, 04 (see note)	
CRC	2 bytes		

Function 06 Hexadecimal (Write Single Holding Register)

This function is used to write a single holding register. The request frame specifies the address of the register (word) to be written and its contents. The correct response is an echo of the request, returned after the contents of the register have been written.

Request frame			
Description	Lenght	Value	Comments
Physical address	1 byte	1 to F7 HEX (1 to 247)	
Function code	1 byte	06 HEX	
Starting address	2 bytes	0000h to FFFF HEX	Bytes order: MSB, LSB
Register value	2 bytes	0000h to FFFF HEX	Bytes order: MSB, LSB
CRC	2 bytes		



Response frame (right action)

Description	Lenght	Value	Comments
Physical address	1 byte	1 to F7 HEX (1 to 247)	
Function code	1 byte	06 HEX	
Starting address	2 bytes	0000h to FFFF HEX	Bytes order: MSB, LSB
Register value	2 bytes	0000h to FFFF HEX	Bytes order: MSB, LSB
CRC	2 bytes		

Response frame (wrong action)

Description	Lenght	Value	Comments
Physical address	1 byte	1 to F7 HEX (1 to 247)	Possible exception:
Function code	1 byte	86 HEX	01: illegal function
Exception code	1 byte	01, 02, 03, 04 (see note)	02: illegal data address
CRC	2 bytes		03: Illegal data value 04: Slave device failure

Function 10 Hexadecimal (Write Multiple Registers)

This function is used to write a block of contiguous registers (maximum of 2). The required values to be written are specified in the data field of the request. The data is packed as two bytes per register.

A correct response returns the function code, the starting address and the number of registers written.

Request frame

Description	Lenght	Value	Comments
Physical address	1 byte	1 to F7 HEX (1 to 247)	
Function code	1 byte	10 HEX	
Starting address	2 bytes	0000 to FFFF HEX	Bytes order: MSB, LSB
Number of registers (N word)	2 bytes	0001 to 0078 HEX	Bytes order: MSB, LSB
Byte counting	1 byte	N word * 2	
Register value	N * 2 bytes	value	Bytes order: MSB, LSB
CRC	2 bytes		

Response frame (right action)

Description	Lenght	Value	Comments
Physical address	1 byte	1 to F7 HEX (1 to 247)	
Function code	1 byte	10 HEX	
Starting address	2 bytes	0000 to FFFF HEX	Bytes order: MSB, LSB
Number of registers (N word)	2 bytes	0001 to 0078 HEX	Bytes order: MSB, LSB
CRC	2 bytes		

Response frame (wrong action)

Description	Lenght	Value	Comments
Physical address	1 byte	1 to F7 HEX (1 to 247)	Possible exception:
Function code	1 byte	90 HEX	01: illegal function
Exception code	1 byte	01, 02, 03, 04 (see note)	02: illegal data address
CRC	2 bytes		03: Illegal data value 04: Slave device failure



CONFIGURATION REGISTER 40007

This 16-bit register regulates the card's main operating settings. Below in detail:

Settings	Value	Detail
Input CT	xxxx xxxx xxxx xxx0	Current input (e.g. TA 5A)
	xxxx xxxx xxxx xxx1	Voltage input (e.g. TA 333 mV, Rogowski)
Calculation method for reactive power	xxxx xxxx xx0x xxxx	Triangular method: This method does not measure reactive power, but calculates it. It is the most commonly used method in energy meters.
	xxxx xxxx xx1x xxxx	Phase-shift method (Budeanu). This method measures reactive power. The accuracy values given are relative to this method.
Three-pole terminal 8-9-10 mode of use	xxxx xxxx x0xx xxxx	Used as RS485: 8 = GND, 9 = B-, 10 = A
	xxxx xxxx x1xx xxxx	Used as digital output between terminals 8 and 10. RS485 communication is still present on the T-Bus connector.
Frequency reading channel	xxxx xxxx 0xxx xxxx	Voltage channel
	xxxx xxxx 1xxx xxxx	Current channel
Voltage input type	xxxx xxx0 xxxx xxxx	Standard load
	xxxx xxx1 xxxx xxxx	PWM type input voltage
Energy data storage	xxxx xx0x xxxx xxxx	Storage disabled
	xxxx xx1x xxxx xxxx	Storage enabled
Dynamic data visualisation	xxx0 0xxx xxxx xxxx	Float
	xxx0 1xxx xxxx xxxx	Inverted Float
	xxx1 0xxx xxxx xxxx	Float hundredths
	xxx1 1xxx xxxx xxxx	Inverted Float hundredths
Integrator	xx0x xxxx xxxx xxxx	Integrator disabled
	xx1x xxxx xxxx xxxx	Integrator enabled for Rogowski input
Digital output behaviour	x0xx x0xx xxxx xxxx	Upward direction: contact normally open
	x1xx x0xx xxxx xxxx	Downward: contact normally closed
	x0xx x1xx xxxx xxxx	Window: contact closed between thresholds
	x1xx x1xx xxxx xxxx	Window: contact closed outside thresholds
Measurement filtering	0xxx xxxx xxxx xxxx	Disabled filtering: less stable measurements, but faster update
	1xxx xxxx xxxx xxxx	Enabled filtering: more stable measurements, but less rapid updating



REGISTER MAP

Default values are in **bold**.

STANDARD VERSION
PLUS AND PRO VERSION
ONLY PRO VERSION

Register Name	Description	Register Type	R/W	Default	Address Modbus
Machine_Id	23 = QE-POWER-T-STD 28 = QE-POWER-T-PLUS 32 = QE-POWER-T-PRO	UShort [16b]	R		40001
HW_FW_version	Hardware (MSB) and Firmware (LSB) Revision	UShort [16b]	R		40002
address	modbus address	UShort [16b]	R/W	1	40003
delay	answer delay expressed as cycles	UShort [16b]	R/W	1	40004
Baudrate	0 → 1200 1 → 2400 2 → 4800 3 → 9600 4 → 19200 5 → 38400 6 → 57600 7 → 115200	UShort [16b]	R/W	3	40005
Parity	0 → NONE 1 → ODD 2 → EVEN	UShort [16b]	R/W	0	40006
Configuration_Flag	Bit[0]: Current Measurement type 0 → Input 1A/5A 1 → Input 333 mV/ Rogowski Bit [1..2]: Connection 0 → Single phase 1 → Three phase: 3 wires, 2 CT (Aron) 2 → Three phase: 3 wires, 3 CT 3 → Three phase: 4 wires, 3 CT (with neutral) Bit [3]: FFT representation 0 → Absolute 1 → Relative to the I1 value Bit[5]: Reactive power calculation method 0 → Triangle method 1 → Budeanu Bit[6]: RS485 as Switch (If DIP1 is ON the value will be forced to be 0 - RS485) 0 → RS485 1 → Switch Bit[7]: Frequency detection Channel 0 → Voltage 1 → Current Bit[8]: Voltage input type 0 → Normal load 1 → PWM modulated input (Inverter Load) Bit[9]: Energy saving 0 → Disabled 1 → Enabled Bit[11..12]: Measurement type 0 → Float 1 → Float Swapped 2 → Hundredth (Float * 100) 3 → Hundredth swapped (Float * 100 SW) Bit[13]: Integrator condition 0 → Integrator disabled 1 → Integrator enabled (Rogowski input) Bit[10, 14]: Output switch initial condition 0 → Closed initial condition 1 → Windowed: closed contact between thresholds 2 → Open initial condition 3 → Windowed: closed contact outside thresholds Bit[15]: Filtered measurement 0 → Filtering disabled 1 → Filtering enabled	UShort [16b]	R/W	16934	40007



Register Name	Description	Register Type	R/W	Default	Address Modbus
Led_settings	Set Fail LED Bit: 0 → Fail Eeprom (settings, calibration or Energy) 1 → Phase reversal (not available in STD version) 2 → I1 Over-range 3 → I1 Under-range 4 → I2 Over-range 5 → I2 Under-range 6 → I3 Over-range 7 → I3 Under-range 8 → V1 Over-range 9 → V1 Under-range 10 → V2 Over-range 11 → V2 Under-range 12 → V3 Over-range 13 → V3 Under-range	UShort [16b]	R/W	1	40008
CT_Transducer_ratio	If Input 1A/5A → Current transformer ratio M/N (Ex: 600:5 → transducer_ratio = 120) If Input Rogowski / 333mV → (1 / Sensitivity) [A/V] (Ex: 100mV/1KA → transducer_ratio = 10000, 333mV/5A → transducer_ratio = 15)	Float [32b-LSW]	R/W	1	40009
CT_Transducer_delay	Current transformer delay in [°] @ 50 Hz for accurate power calculation	Float [32b-LSW]	R/W	0	40011
VT_Transducer_ratio	Voltage transformer ratio M/N - Default 1.0 (Ex: 1000:100 → transducer_ratio = 10)	Float [32b-LSW]	R/W	1	40013
VT_Transducer_delay	Voltage transformer delay in [°] @ 50 Hz for accurate power calculation	Float [32b-LSW]	R/W	0	40015
minimum_voltage_ripple	Minimum threshold under which the instrument reads 0 independent from the input value	Float [32b-LSW]	R/W	0	40017
minimum_current_ripple	Minimum threshold under which the instrument reads 0 independent from the input value	Float [32b-LSW]	R/W	0	40019
minimum_power_ripple	Minimum threshold under which the instrument reads 0 independent from the input value (P, Q, and S)	Float [32b-LSW]	R/W	0	40021
DC_Filter	Number of tenth seconds for I RMS value in DC	UShort [16b]	R/W	10	40023
AC_Filter	Number of zero crossings for I RMS value in AC	UShort [16b]	R/W	50	40024
minute_for_Max_demand	Minute for Max demand calculation (0..45)	UShort [16b]	R/W	15	40025
Or_settings	Register to enable for multiple alarms settings Bit: 0 → Over/under value phase 1 1 → Over/under value phase 2 2 → Over/under value phase 3 3 → missing phase 1 4 → missing phase 2 5 → missing phase 3 6 → Asymmetry 7 → Phase sequence 15 → Or_Alarm_enable	UShort [16b]	R/W	0	40026
seconds_for_mean_RMS	Register in seconds (0..30) for RMS average	UShort [16b]	R/W	0	40027
seconds_for_MAX_RMS	Seconds 1..30 for MAX RMS value. If the register is 0, then the absolute MAX RMS is given	UShort [16b]	R/W	0	40028
seconds_for_min_RMS	Seconds 1..30 for min RMS value. If the register is 0, then the absolute min RMS is given	UShort [16b]	R/W	0	40029
Energy_unit_factor	Variable for changing Energy measurement unit: 0 → [Wh/10] 1 → [Wh] 4 → [kWh]	UShort [16b]	R/W	0	40030
Voltage_unbalance_setpoint	Setpoint for Voltage Unbalance Alarm	Float [32b-LSW]	R/W	0	40031



Register Name	Description	Register Type	R/W	Default	Address Modbus
Phase_custom_configuration	Configuration for customizing the Current and Voltage Terminal * Bit 0..2: Voltage terminal settings * Terminal 16 17 18 * 000 -> L1 L2 L3 * 001 -> L3 L1 L2 * 010 -> L2 L3 L1 * 011 -> L1 L3 L2 * 100 -> L3 L2 L1 * 101 -> L2 L1 L3 * * Bit 3..5: Current terminal settings * Terminal 1-2 3-4 5-6 * 000 -> I1 I2 I3 * 001 -> I3 I1 I2 * 010 -> I2 I3 I1 * 011 -> I1 I3 I2 * 100 -> I3 I2 I1 * 101 -> I2 I1 I3 * * Bit 6,7,8: Current direction I1, I2, I3 * 0 -> Normal * 1 -> Inverse * * Bit 15: Phase custom configuration * 0 -> Disable * 1 -> Enable	UShort [16b]	R/W	0	40033
Alarm_delay	Delay in ms for Alarm trigger	UShort [16b]	R/W	0	40035
Alarm_Register_start_address	Float [32b-LSW] value Starting address for alarm (40361 V_L1_N, 40363 V_L2_N, 40365 V_L3_N, ecc)	UShort [16b]	R/W	40361	40036
Alarm_trip_value	Alarm Threshold for "closed" and "open" condition OR first alarm threshold for "within threshold" and "Outside threshold" condition	Float [32b-LSW]	R/W	0	40037
Alarm_hysteresis	Alarm Hysteresis	Float [32b-LSW]	R/W	1	40039
Alarm_trip_value_2	Second alarm Threshold for "within threshold" and "Outside threshold" condition	Float [32b-LSW]	R/W		40041
Power_Threshold_for_exceedings	Threshold for Power exceedings monitoring	Float [32b-LSW]	R/W	0	40043
Nominal_Star_Voltage	Nominal Star Voltage for Sag, Swell, Interruption monitoring [V]	Float [32b-LSW]	R/W	230	40045
Sag_percentage_level	Percentage over Nominal_Star_Voltage under which a Sag event is generated (default 0.9 = 90 %); must be over Interruption_percentage_level	Float [32b-LSW]	R/W	0,9	40047
Swell_percentage_level	Percentage over Nominal_Star_Voltage over which a Swell event is generated (default 1.1 = 110 %)	Float [32b-LSW]	R/W	1,1	40049
Interruption_percentage_level	Percentage over Nominal_Star_Voltage under which an Interruption event is generated (default 0.1 = 10 %)	Float [32b-LSW]	R/W	0,1	40051
Minimum_duration_cutoff	Sag, Swell or Interruption events must be above this cutoff to be displayed and saved [ms]	UShort [16b]	R/W	0	40053
Status_1	bit 0: flash settings error; bit 1: flash calibration error; bit 2: Current I1 Over Range; bit 3: Current I1 Under Range; bit 4: Current I2 Over Range; bit 5: Current I2 Under Range; bit 6: Current I3 Over Range; bit 7: Current I3 Under Range; bit 8: Current V1 Over Range; bit 9: Current V1 Under Range; bit 10: Current V2 Over Range; bit 11: Current V2 Under Range; bit 12: Current V3 Over Range; bit 13: Current V3 Under Range; bit 14: Zero crossing detecting; bit 15: Switch open; bit 16: Wh storing error; bit 17..18: don't care; bit 19: Alarm detection; bit 20..27: don't care; bit 28: Leading Power factor PF1; bit 29: Leading Power factor PF2; bit 30: Leading Power factor PF3;	ULong [32b-LSW]	R		40239



Register Name	Description	Register Type	R/W	Default	Address Modbus
Command	0xC1C0 = Flash settings save command 0xC1A0 = Reboot command 0xBABA = Save energy command 0xDAAA = Close Switch command (only if Digital Output is enabled) 0xDAAB = Open Switch command (only if Digital Output is enabled) 0xB000 = Enter Bootloader command 0xE000 = Read previous SAG event in EEprom 0xE001 = Read previous SWELL event in EEprom 0xE002 = Read previous INTERRUPTION event in EEprom 0xE100 = Reset SAG events in EEprom 0xE101 = Reset SWELL events in EEprom 0xE102 = Reset INTERRUPTION events in EEprom 0xF000 = Reset MAX Demand registers command	UShort [16b]	R/W		40244
KWh1	Active energy line 1 [Wh tenth]	Int [64b-LSW]	R/W		40245
KWh2	Active energy line 2 [Wh tenth]	Int [64b-LSW]	R/W		40249
KWh3	Active energy line 3 [Wh tenth]	Int [64b-LSW]	R/W		40253
KWh_SUM	Active energy three phase [Wh tenth]	Int [64b-LSW]	R		40257
KWh1_Plus	Positive Active energy line 1 [Wh tenth]	Int [64b-LSW]	R/W		40261
KWh2_Plus	Positive Active energy line 2 [Wh tenth]	Int [64b-LSW]	R/W		40265
KWh3_Plus	Positive Active energy line 3 [Wh tenth]	Int [64b-LSW]	R/W		40269
KWh_SUM_Plus	Positive Active energy three phase [Wh tenth]	Int [64b-LSW]	R		40273
KWh1_Neg	Negative Active energy line 1 [Wh tenth]	Int [64b-LSW]	R/W		40277
KWh2_Neg	Negative Active energy line 2 [Wh tenth]	Int [64b-LSW]	R/W		40281
KWh3_Neg	Negative Active energy line 3 [Wh tenth]	Int [64b-LSW]	R/W		40285
KWh_SUM_Neg	Negative Active energy three phase [Wh tenth]	Int [64b-LSW]	R		40289
KVARh1	Reactive energy line 1 [VARh tenth]	Int [64b-LSW]	R/W		40293
KVARh2	Reactive energy line 2 [VARh tenth]	Int [64b-LSW]	R/W		40297
KVARh3	Reactive energy line 3 [VARh tenth]	Int [64b-LSW]	R/W		40301
KVARh_SUM	Reactive energy three phase [VARh tenth]	Int [64b-LSW]	R		40305
KVARh1_Inductive	Inductive Reactive energy line 1 [VARh tenth]	Int [64b-LSW]	R/W		40309
KVARh2_Inductive	Inductive Reactive energy line 2 [VARh tenth]	Int [64b-LSW]	R/W		40313
KVARh3_Inductive	Inductive Reactive energy line 3 [VARh tenth]	Int [64b-LSW]	R/W		40317
KVARh_SUM_Inductive	Inductive Reactive energy three phase [VARh tenth]	Int [64b-LSW]	R		40321
KVARh1_Capacitive	Capacitive Reactive energy line 1 [VARh tenth]	Int [64b-LSW]	R/W		40325
KVARh2_Capacitive	Capacitive Reactive energy line 2 [VARh tenth]	Int [64b-LSW]	R/W		40329
KVARh3_Capacitive	Capacitive Reactive energy line 3 [VARh tenth]	Int [64b-LSW]	R/W		40333
KVARh_SUM_Capacitive	Capacitive Reactive energy three phase [VARh tenth]	Int [64b-LSW]	R		40337
KVAh1	Apparent energy line 1 [VAh tenth]	Int [64b-LSW]	R/W		40341
KVAh2	Apparent energy line 2 [VAh tenth]	Int [64b-LSW]	R/W		40345
KVAh3	Apparent energy line 3 [VAh tenth]	Int [64b-LSW]	R/W		40349
KVAh_SUM	Apparent energy three phase [VAh tenth]	Int [64b-LSW]	R		40353
Wh_storage_count	Number of Wh flash savings (every 20 seconds)	ULong [32b-LSW]	R		40357
V_L1_N	RMS star voltage L1-N [V]	Float [32b-LSW]	R		40359
V_L2_N	RMS star voltage L2-N [V]	Float [32b-LSW]	R		40361
V_L3_N	RMS star voltage L3-N [V]	Float [32b-LSW]	R		40363
V_STAR_AVG	RMS star avg value voltage [V]	Float [32b-LSW]	R		40365
V_L1_L2	RMS line voltage L1-L2 [V]	Float [32b-LSW]	R		40367
V_L2_L3	RMS line voltage L2-L3 [V]	Float [32b-LSW]	R		40369
V_L3_L1	RMS line voltage L3-L1 [V]	Float [32b-LSW]	R		40371
V_LINE_AVG	RMS line avg value voltage [V]	Float [32b-LSW]	R		40373
I_L1	RMS line current L1 [A]	Float [32b-LSW]	R		40375
I_L2	RMS line current L2 [A]	Float [32b-LSW]	R		40377
I_L3	RMS line current L3 [A]	Float [32b-LSW]	R		40379
I_N	RMS line current N [A] (if 1 or 2 TA connection, I_N = 0)	Float [32b-LSW]	R		40381
I_AVG	RMS avg value current [A] (excluding neutral current I_N)	Float [32b-LSW]	R		40383
P1	RMS active power line 1 [W]	Float [32b-LSW]	R		40385
P2	RMS active power line 2 [W]	Float [32b-LSW]	R		40387
P3	RMS active power line 3 [W]	Float [32b-LSW]	R		40389
P_SUM	RMS sum active power [W]	Float [32b-LSW]	R		40391
Q1	RMS reactive power line 1 [VAR]	Float [32b-LSW]	R		40393
Q2	RMS reactive power line 2 [VAR]	Float [32b-LSW]	R		40395
Q3	RMS reactive power line 3 [VAR]	Float [32b-LSW]	R		40397
Q_SUM	RMS sum reactive power [VAR]	Float [32b-LSW]	R		40399
S1	RMS apparent power line 1 [VA]	Float [32b-LSW]	R		40401
S2	RMS apparent power line 2 [VA]	Float [32b-LSW]	R		40403



Register Name	Description	Register Type	R/W	Default	Address Modbus
S3	RMS apparent power line 3 [VA]	Float [32b-LSW]	R		40405
S_SUM	RMS sum apparent power [VA]	Float [32b-LSW]	R		40407
PF1	Power Factor line 1	Float [32b-LSW]	R		40409
PF2	Power Factor line 2	Float [32b-LSW]	R		40411
PF3	Power Factor line 3	Float [32b-LSW]	R		40413
PF_3PH	Three Phase Power Factor	Float [32b-LSW]	R		40415
CF1	Crest Factor line 1	Float [32b-LSW]	R		40417
CF2	Crest Factor line 2	Float [32b-LSW]	R		40419
CF3	Crest Factor line 3	Float [32b-LSW]	R		40421
CF_N	Crest Factor Neutral	Float [32b-LSW]	R		40423
Frequency	Frequency [Hz]	Float [32b-LSW]	R		40425
V_L1_N_peak	Star voltage L1-N peak [V]	Float [32b-LSW]	R/W		40427
V_L2_N_peak	Star voltage L2-N peak [V]	Float [32b-LSW]	R/W		40429
V_L3_N_peak	Star voltage L3-N peak [V]	Float [32b-LSW]	R/W		40431
V_L1_L2_peak	Line voltage L1-L2 peak [V]	Float [32b-LSW]	R/W		40433
V_L2_L3_peak	Line voltage L2-L3 peak [V]	Float [32b-LSW]	R/W		40435
V_L3_L1_peak	Line voltage L3-L1 peak [V]	Float [32b-LSW]	R/W		40437
I_L1_peak	L1 current peak [A]	Float [32b-LSW]	R/W		40439
I_L2_peak	L2 current peak [A]	Float [32b-LSW]	R/W		40441
I_L3_peak	L3 current peak [A]	Float [32b-LSW]	R/W		40443
I_N_peak	N current peak [A]	Float [32b-LSW]	R/W		40445
DPF1	Distortion Power Factor line 1 (+ inductive, - capacitive)	Float [32b-LSW]	R		40467
DPF2	Distortion Power Factor line 2 (+ inductive, - capacitive)	Float [32b-LSW]	R		40469
DPF3	Distortion Power Factor line 3 (+ inductive, - capacitive)	Float [32b-LSW]	R		40471
DPF_N	Neutral Distortion Power Factor (+ inductive, - capacitive)	Float [32b-LSW]	R		40473
TAN_FI_1	Tangentθline 1 (+ inductive, - capacitive)	Float [32b-LSW]	R		40475
TAN_FI_2	Tangentθline 2 (+ inductive, - capacitive)	Float [32b-LSW]	R		40477
TAN_FI_3	Tangentθline 3 (+ inductive, - capacitive)	Float [32b-LSW]	R		40479
TAN_FI_AVG	Average Tangentθ(+ inductive, - capacitive)	Float [32b-LSW]	R		40481
Phase_Order	L1, L2, L3 = 0; L1, L3, L2 = 1	Float [32b-LSW]	R		40483
Internal_temperature	Internal Temperature [°C]	Float [32b-LSW]	R		40485
V_L1_N_RMS_AVG	Star voltage L1_N RMS average [V] over "seconds_for_mean_RMS"	Float [32b-LSW]	R		40487
V_L1_N_RMS_MAX	Star voltage L1_N MAX RMS [V] over last "seconds_for_MAX_RMS"	Float [32b-LSW]	R		40489
V_L1_N_RMS_min	Star voltage L1_N Min RMS [V] over last"seconds_for_min_RMS"	Float [32b-LSW]	R		40491
V_L2_N_RMS_AVG	Star voltage L2_N RMS average [V] over "seconds_for_mean_RMS"	Float [32b-LSW]	R		40493
V_L2_N_RMS_MAX	Star voltage L2_N MAX RMS [V] over last "seconds_for_MAX_RMS"	Float [32b-LSW]	R		40495
V_L2_N_RMS_min	Star voltage L2_N Min RMS [V] over last"seconds_for_min_RMS"	Float [32b-LSW]	R		40497
V_L3_N_RMS_AVG	Star voltage L3_N RMS average [V] over "seconds_for_mean_RMS"	Float [32b-LSW]	R		40499
V_L3_N_RMS_MAX	Star voltage L3_N MAX RMS [V] over last "seconds_for_MAX_RMS"	Float [32b-LSW]	R		40501
V_L3_N_RMS_min	Star voltage L3_N Min RMS [V] over last"seconds_for_min_RMS"	Float [32b-LSW]	R		40503
V_STAR_AVG_RMS_AVG	Star voltage AVG RMS average [V] over "seconds_for_mean_RMS"	Float [32b-LSW]	R		40505
V_STAR_AVG_RMS_MAX	Star voltage AVG MAX RMS [V] over last "seconds_for_MAX_RMS"	Float [32b-LSW]	R		40507
V_STAR_AVG_RMS_min	Star voltage AVG Min RMS [V] over last"seconds_for_min_RMS"	Float [32b-LSW]	R		40509
V_L1_L2_RMS_AVG	Line voltage L1-L2 RMS average [V] over "seconds_for_mean_RMS"	Float [32b-LSW]	R		40511
V_L1_L2_RMS_MAX	Line voltage L1-L2 MAX RMS [V] over last "seconds_for_MAX_RMS"	Float [32b-LSW]	R		40513
V_L1_L2_RMS_min	Line voltage L1-L2 Min RMS [V] over last"seconds_for_min_RMS"	Float [32b-LSW]	R		40515
V_L2_L3_RMS_AVG	Line voltage L2-L3 RMS average [V] over "seconds_for_mean_RMS"	Float [32b-LSW]	R		40517
V_L2_L3_RMS_MAX	Line voltage L2-L3 MAX RMS [V] over last "seconds_for_MAX_RMS"	Float [32b-LSW]	R		40519
V_L2_L3_RMS_min	Line voltage L2-L3 Min RMS [V] over last"seconds_for_min_RMS"	Float [32b-LSW]	R		40521
V_L3_L1_RMS_AVG	Line voltage L3-L1 RMS average [V] over "seconds_for_mean_RMS"	Float [32b-LSW]	R		40523
V_L3_L1_RMS_MAX	Line voltage L3-L1 MAX RMS [V] over last "seconds_for_MAX_RMS"	Float [32b-LSW]	R		40525
V_L3_L1_RMS_min	Line voltage L3-L1 Min RMS [V] over last"seconds_for_min_RMS"	Float [32b-LSW]	R		40527
V_LINE_AVG_RMS_AVG	Line voltage AVG RMS average [V] over "seconds_for_mean_RMS"	Float [32b-LSW]	R		40529
V_LINE_AVG_RMS_MAX	Line voltage AVG MAX RMS [V] over last "seconds_for_MAX_RMS"	Float [32b-LSW]	R		40531
V_LINE_AVG_RMS_min	Line voltage AVG Min RMS [V] over last"seconds_for_min_RMS"	Float [32b-LSW]	R		40533
I_L1_RMS_AVG	L1 RMS average [A] over "seconds_for_mean_RMS"	Float [32b-LSW]	R		40535
I_L1_RMS_MAX	L1 MAX RMS [A] over last "seconds_for_MAX_RMS"	Float [32b-LSW]	R		40537
I_L1_RMS_min	L1 Min RMS [A] over last"seconds_for_min_RMS"	Float [32b-LSW]	R		40539
I_L2_RMS_AVG	L2 RMS average [A] over "seconds_for_mean_RMS"	Float [32b-LSW]	R		40541



Register Name	Description	Register Type	R/W	Default	Address Modbus
L_L2_RMS_MAX	L2 MAX RMS [A] over last "seconds_for_MAX_RMS"	Float [32b-LSW]	R		40543
L_L2_RMS_min	L2 Min RMS [A] over last"seconds_for_min_RMS"	Float [32b-LSW]	R		40545
L_L3_RMS_AVG	L3 RMS average [A] over "seconds_for_mean_RMS"	Float [32b-LSW]	R		40547
L_L3_RMS_MAX	L3 MAX RMS [A] over last "seconds_for_MAX_RMS"	Float [32b-LSW]	R		40549
L_L3_RMS_min	L3 Min RMS [A] over last"seconds_for_min_RMS"	Float [32b-LSW]	R		40551
L_N_RMS_AVG	N RMS average [A] over "seconds_for_mean_RMS"	Float [32b-LSW]	R		40553
L_N_RMS_MAX	N MAX RMS [A] over last "seconds_for_MAX_RMS"	Float [32b-LSW]	R		40555
L_N_RMS_min	N Min RMS [A] over last"seconds_for_min_RMS"	Float [32b-LSW]	R		40557
L_AVG_RMS_AVG	L_AVG RMS average [A] over "seconds_for_mean_RMS"	Float [32b-LSW]	R		40559
L_AVG_RMS_MAX	L_AVG MAX RMS [A] over last "seconds_for_MAX_RMS"	Float [32b-LSW]	R		40561
L_AVG_RMS_min	L_AVG Min RMS [A] over last"seconds_for_min_RMS"	Float [32b-LSW]	R		40563
P1_RMS_AVG	P1 RMS average [A] over "seconds_for_mean_RMS"	Float [32b-LSW]	R		40565
P1_RMS_MAX	P1 MAX RMS [A] over last "seconds_for_MAX_RMS"	Float [32b-LSW]	R		40567
P1_RMS_min	P1 Min RMS [A] over last"seconds_for_min_RMS"	Float [32b-LSW]	R		40569
P2_RMS_AVG	P2 RMS average [A] over "seconds_for_mean_RMS"	Float [32b-LSW]	R		40571
P2_RMS_MAX	P2 MAX RMS [A] over last "seconds_for_MAX_RMS"	Float [32b-LSW]	R		40573
P2_RMS_min	P2 Min RMS [A] over last"seconds_for_min_RMS"	Float [32b-LSW]	R		40575
P3_RMS_AVG	P3 RMS average [A] over "seconds_for_mean_RMS"	Float [32b-LSW]	R		40577
P3_RMS_MAX	P3 MAX RMS [A] over last "seconds_for_MAX_RMS"	Float [32b-LSW]	R		40579
P3_RMS_min	P3 Min RMS [A] over last"seconds_for_min_RMS"	Float [32b-LSW]	R		40581
P_SUM_RMS_AVG	P_SUM RMS average [A] over "seconds_for_mean_RMS"	Float [32b-LSW]	R		40583
P_SUM_RMS_MAX	P_SUM MAX RMS [A] over last "seconds_for_MAX_RMS"	Float [32b-LSW]	R		40585
P_SUM_RMS_min	P_SUM Min RMS [A] over last"seconds_for_min_RMS"	Float [32b-LSW]	R		40587
Q1_RMS_AVG	Q1 RMS average [A] over "seconds_for_mean_RMS"	Float [32b-LSW]	R		40589
Q1_RMS_MAX	Q1 MAX RMS [A] over last "seconds_for_MAX_RMS"	Float [32b-LSW]	R		40591
Q1_RMS_min	Q1 Min RMS [A] over last"seconds_for_min_RMS"	Float [32b-LSW]	R		40593
Q2_RMS_AVG	Q2 RMS average [A] over "seconds_for_mean_RMS"	Float [32b-LSW]	R		40595
Q2_RMS_MAX	Q2 MAX RMS [A] over last "seconds_for_MAX_RMS"	Float [32b-LSW]	R		40597
Q2_RMS_min	Q2 Min RMS [A] over last"seconds_for_min_RMS"	Float [32b-LSW]	R		40599
Q3_RMS_AVG	Q3 RMS average [A] over "seconds_for_mean_RMS"	Float [32b-LSW]	R		40601
Q3_RMS_MAX	Q3 MAX RMS [A] over last "seconds_for_MAX_RMS"	Float [32b-LSW]	R		40603
Q3_RMS_min	Q3 Min RMS [A] over last"seconds_for_min_RMS"	Float [32b-LSW]	R		40605
Q_SUM_RMS_AVG	Q_SUM RMS average [A] over "seconds_for_mean_RMS"	Float [32b-LSW]	R		40607
Q_SUM_RMS_MAX	Q_SUM MAX RMS [A] over last "seconds_for_MAX_RMS"	Float [32b-LSW]	R		40609
Q_SUM_RMS_min	Q_SUM Min RMS [A] over last"seconds_for_min_RMS"	Float [32b-LSW]	R		40611
S1_RMS_AVG	S1 RMS average [A] over "seconds_for_mean_RMS"	Float [32b-LSW]	R		40613
S1_RMS_MAX	S1 MAX RMS [A] over last "seconds_for_MAX_RMS"	Float [32b-LSW]	R		40615
S1_RMS_min	S1 Min RMS [A] over last"seconds_for_min_RMS"	Float [32b-LSW]	R		40617
S2_RMS_AVG	S2 RMS average [A] over "seconds_for_mean_RMS"	Float [32b-LSW]	R		40619
S2_RMS_MAX	S2 MAX RMS [A] over last "seconds_for_MAX_RMS"	Float [32b-LSW]	R		40621
S2_RMS_min	S2 Min RMS [A] over last"seconds_for_min_RMS"	Float [32b-LSW]	R		40623
S3_RMS_AVG	S3 RMS average [A] over "seconds_for_mean_RMS"	Float [32b-LSW]	R		40625
S3_RMS_MAX	S3 MAX RMS [A] over last "seconds_for_MAX_RMS"	Float [32b-LSW]	R		40627
S3_RMS_min	S3 Min RMS [A] over last"seconds_for_min_RMS"	Float [32b-LSW]	R		40629
S_SUM_RMS_AVG	S_SUM RMS average [A] over "seconds_for_mean_RMS"	Float [32b-LSW]	R		40631
S_SUM_RMS_MAX	S_SUM MAX RMS [A] over last "seconds_for_MAX_RMS"	Float [32b-LSW]	R		40633
S_SUM_RMS_min	S_SUM Min RMS [A] over last"seconds_for_min_RMS"	Float [32b-LSW]	R		40635
PF1_RMS_AVG	PF1 RMS average [A] over "seconds_for_mean_RMS"	Float [32b-LSW]	R		40637
PF1_RMS_MAX	PF1 MAX RMS [A] over last "seconds_for_MAX_RMS"	Float [32b-LSW]	R		40639
PF1_RMS_min	PF1 Min RMS [A] over last"seconds_for_min_RMS"	Float [32b-LSW]	R		40641
PF2_RMS_AVG	PF2 RMS average [A] over "seconds_for_mean_RMS"	Float [32b-LSW]	R		40643
PF2_RMS_MAX	PF2 MAX RMS [A] over last "seconds_for_MAX_RMS"	Float [32b-LSW]	R		40645
PF2_RMS_min	PF2 Min RMS [A] over last"seconds_for_min_RMS"	Float [32b-LSW]	R		40647
PF3_RMS_AVG	PF3 RMS average [A] over "seconds_for_mean_RMS"	Float [32b-LSW]	R		40649
PF3_RMS_MAX	PF3 MAX RMS [A] over last "seconds_for_MAX_RMS"	Float [32b-LSW]	R		40651
PF3_RMS_min	PF3 Min RMS [A] over last"seconds_for_min_RMS"	Float [32b-LSW]	R		40653
PF_SUM_RMS_AVG	PF_SUM RMS average [A] over "seconds_for_mean_RMS"	Float [32b-LSW]	R		40655
PF_SUM_RMS_MAX	PF_SUM MAX RMS [A] over last "seconds_for_MAX_RMS"	Float [32b-LSW]	R		40657
PF_SUM_RMS_min	PF_SUM Min RMS [A] over last"seconds_for_min_RMS"	Float [32b-LSW]	R		40659
P1_Time_over_threshold	Time above threshold specified in "Power_Threshold_for_exceedings" for Active Power P1 [min]	Float [32b-LSW]	R		40661
P2_Time_over_threshold	Time above threshold specified in "Power_Threshold_for_exceedings" for Active Power P2 [min]	Float [32b-LSW]	R		40663



Register Name	Description	Register Type	R/W	Default	Address Modbus
P3_Time_over_threshold	Time above threshold specified in "Power_Threshold_for_exceedings" for Active Power P3 [min]	Float [32b-LSW]	R		40665
P_SUM_Time_over_threshold	Time above threshold specified in "Power_Threshold_for_exceedings" for Active Power P_SUM [min]	Float [32b-LSW]	R		40667
P1_MaxDemand	Max Demand over 15 minutes for P1 for current month	Float [32b-LSW]	R		40669
P2_MaxDemand	Max Demand over 15 minutes for P2 for current month	Float [32b-LSW]	R		40671
P3_MaxDemand	Max Demand over 15 minutes for P3 for current month	Float [32b-LSW]	R		40673
P_SUM_MaxDemand	Max Demand over 15 minutes for P three phase for current month	Float [32b-LSW]	R		40675
Time_of_P1_MaxDemand	Time at which arises Max Demand over 15 minutes for P1 for current month (month day hour minutes)	ULong [32b-LSW]	R		40677
Time_of_P2_MaxDemand	Time at which arises Max Demand over 15 minutes for P2 for current month (month day hour minutes)	ULong [32b-LSW]	R		40679
Time_of_P3_MaxDemand	Time at which arises Max Demand over 15 minutes for P3 for current month (month day hour minutes)	ULong [32b-LSW]	R		40681
Time_of_P_SUM_MaxDemand	Time at which arises Max Demand over 15 minutes for P three phase for current month (month day hour minutes)	ULong [32b-LSW]	R		40683
K_factor_I1	K-factor for I1, see IEEE Standard 1100-1992	Float [32b-LSW]	R		40685
K_factor_I2	K-factor for I2, see IEEE Standard 1100-1992	Float [32b-LSW]	R		40687
K_factor_I3	K-factor for I3, see IEEE Standard 1100-1992	Float [32b-LSW]	R		40689
Year	RTC: year (2000-2099)	UShort [16b]	R/W		40691
Month	RTC : month (1-12)	UShort [16b]	R/W		40692
Day	RTC : day month (1-31)	UShort [16b]	R/W		40693
Hour	RTC : hour (0-23)	UShort [16b]	R/W		40694
Minute	RTC : minute (0-59)	UShort [16b]	R/W		40695
Seconds	RTC : second (0-59)	UShort [16b]	R/W		40696
THD_V_L1	THD Star Voltage L1	Float [32b-LSW]	R		40697
THD_V_L2	THD Star Voltage L2	Float [32b-LSW]	R		40699
THD_V_L3	THD Star Voltage L3	Float [32b-LSW]	R		40701
THD_V_L12	THD Line Voltage L1-L2	Float [32b-LSW]	R		40703
THD_V_L23	THD Line Voltage L2-L3	Float [32b-LSW]	R		40705
THD_V_L31	THD Line Voltage L3-L1	Float [32b-LSW]	R		40707
THD_I_L1	THD Line Current L1	Float [32b-LSW]	R		40709
THD_I_L2	THD Line Current L2	Float [32b-LSW]	R		40711
THD_I_L3	THD Line Current L3	Float [32b-LSW]	R		40713
THD_I_N	THD Neutral Current	Float [32b-LSW]	R		40715
TDD_I_L1	TDD Line Current L1	Float [32b-LSW]	R		40717
TDD_I_L2	TDD Line Current L2	Float [32b-LSW]	R		40719
TDD_I_L3	TDD Line Current L3	Float [32b-LSW]	R		40721
Voltage_unbalance	Voltage Unbalance of the three phase system	Float [32b-LSW]	R		40723
V_L1N_H_0	Star Voltage L1-N Harmonic #0	Float [32b-LSW]	R		40737
V_L1N_H_1	Star Voltage L1-N Harmonic #1	Float [32b-LSW]	R		40739
V_L1N_H_2	Star Voltage L1-N Harmonic #2	Float [32b-LSW]	R		40741
V_L1N_H_3	Star Voltage L1-N Harmonic #3	Float [32b-LSW]	R		40743
V_L1N_H_4	Star Voltage L1-N Harmonic #4	Float [32b-LSW]	R		40745
V_L1N_H_5	Star Voltage L1-N Harmonic #5	Float [32b-LSW]	R		40747
V_L1N_H_6	Star Voltage L1-N Harmonic #6	Float [32b-LSW]	R		40749
V_L1N_H_7	Star Voltage L1-N Harmonic #7	Float [32b-LSW]	R		40751
V_L1N_H_8	Star Voltage L1-N Harmonic #8	Float [32b-LSW]	R		40753
V_L1N_H_9	Star Voltage L1-N Harmonic #9	Float [32b-LSW]	R		40755
V_L1N_H_10	Star Voltage L1-N Harmonic #10	Float [32b-LSW]	R		40757
V_L1N_H_11	Star Voltage L1-N Harmonic #11	Float [32b-LSW]	R		40759
V_L1N_H_12	Star Voltage L1-N Harmonic #12	Float [32b-LSW]	R		40761
V_L1N_H_13	Star Voltage L1-N Harmonic #13	Float [32b-LSW]	R		40763
V_L1N_H_14	Star Voltage L1-N Harmonic #14	Float [32b-LSW]	R		40765
V_L1N_H_15	Star Voltage L1-N Harmonic #15	Float [32b-LSW]	R		40767
V_L1N_H_16	Star Voltage L1-N Harmonic #16	Float [32b-LSW]	R		40769
V_L1N_H_17	Star Voltage L1-N Harmonic #17	Float [32b-LSW]	R		40771
V_L1N_H_18	Star Voltage L1-N Harmonic #18	Float [32b-LSW]	R		40773
V_L1N_H_19	Star Voltage L1-N Harmonic #19	Float [32b-LSW]	R		40775
V_L1N_H_20	Star Voltage L1-N Harmonic #20	Float [32b-LSW]	R		40777
V_L1N_H_21	Star Voltage L1-N Harmonic #21	Float [32b-LSW]	R		40779
V_L1N_H_22	Star Voltage L1-N Harmonic #22	Float [32b-LSW]	R		40781
V_L1N_H_23	Star Voltage L1-N Harmonic #23	Float [32b-LSW]	R		40783
V_L1N_H_24	Star Voltage L1-N Harmonic #24	Float [32b-LSW]	R		40785



Register Name	Description	Register Type	R/W	Default	Address Modbus
V_L1N_H_25	Star Voltage L1-N Harmonic #25	Float [32b-LSW]	R		40787
V_L1N_H_26	Star Voltage L1-N Harmonic #26	Float [32b-LSW]	R		40789
V_L1N_H_27	Star Voltage L1-N Harmonic #27	Float [32b-LSW]	R		40791
V_L1N_H_28	Star Voltage L1-N Harmonic #28	Float [32b-LSW]	R		40793
V_L1N_H_29	Star Voltage L1-N Harmonic #29	Float [32b-LSW]	R		40795
V_L1N_H_30	Star Voltage L1-N Harmonic #30	Float [32b-LSW]	R		40797
V_L1N_H_31	Star Voltage L1-N Harmonic #31	Float [32b-LSW]	R		40799
V_L1N_H_32	Star Voltage L1-N Harmonic #32	Float [32b-LSW]	R		40801
V_L1N_H_33	Star Voltage L1-N Harmonic #33	Float [32b-LSW]	R		40803
V_L1N_H_34	Star Voltage L1-N Harmonic #34	Float [32b-LSW]	R		40805
V_L1N_H_35	Star Voltage L1-N Harmonic #35	Float [32b-LSW]	R		40807
V_L1N_H_36	Star Voltage L1-N Harmonic #36	Float [32b-LSW]	R		40809
V_L1N_H_37	Star Voltage L1-N Harmonic #37	Float [32b-LSW]	R		40811
V_L1N_H_38	Star Voltage L1-N Harmonic #38	Float [32b-LSW]	R		40813
V_L1N_H_39	Star Voltage L1-N Harmonic #39	Float [32b-LSW]	R		40815
V_L1N_H_40	Star Voltage L1-N Harmonic #40	Float [32b-LSW]	R		40817
V_L1N_H_41	Star Voltage L1-N Harmonic #41	Float [32b-LSW]	R		40819
V_L1N_H_42	Star Voltage L1-N Harmonic #42	Float [32b-LSW]	R		40821
V_L1N_H_43	Star Voltage L1-N Harmonic #43	Float [32b-LSW]	R		40823
V_L1N_H_44	Star Voltage L1-N Harmonic #44	Float [32b-LSW]	R		40825
V_L1N_H_45	Star Voltage L1-N Harmonic #45	Float [32b-LSW]	R		40827
V_L1N_H_46	Star Voltage L1-N Harmonic #46	Float [32b-LSW]	R		40829
V_L1N_H_47	Star Voltage L1-N Harmonic #47	Float [32b-LSW]	R		40831
V_L1N_H_48	Star Voltage L1-N Harmonic #48	Float [32b-LSW]	R		40833
V_L1N_H_49	Star Voltage L1-N Harmonic #49	Float [32b-LSW]	R		40835
V_L1N_H_50	Star Voltage L1-N Harmonic #50	Float [32b-LSW]	R		40837
V_L1N_H_51	Star Voltage L1-N Harmonic #51	Float [32b-LSW]	R		40839
V_L1N_H_52	Star Voltage L1-N Harmonic #52	Float [32b-LSW]	R		40841
V_L1N_H_53	Star Voltage L1-N Harmonic #53	Float [32b-LSW]	R		40843
V_L1N_H_54	Star Voltage L1-N Harmonic #54	Float [32b-LSW]	R		40845
V_L1N_H_55	Star Voltage L1-N Harmonic #55	Float [32b-LSW]	R		40847
V_L1N_H_56	Star Voltage L1-N Harmonic #56	Float [32b-LSW]	R		40849
V_L1N_H_57	Star Voltage L1-N Harmonic #57	Float [32b-LSW]	R		40851
V_L1N_H_58	Star Voltage L1-N Harmonic #58	Float [32b-LSW]	R		40853
V_L1N_H_59	Star Voltage L1-N Harmonic #59	Float [32b-LSW]	R		40855
V_L1N_H_60	Star Voltage L1-N Harmonic #60	Float [32b-LSW]	R		40857
V_L1N_H_61	Star Voltage L1-N Harmonic #61	Float [32b-LSW]	R		40859
V_L1N_H_62	Star Voltage L1-N Harmonic #62	Float [32b-LSW]	R		40861
V_L1N_H_63	Star Voltage L1-N Harmonic #63	Float [32b-LSW]	R		40863
V_L2N_H_0	Star Voltage L2-N Harmonic #0	Float [32b-LSW]	R		40865
V_L2N_H_1	Star Voltage L2-N Harmonic #1	Float [32b-LSW]	R		40867
V_L2N_H_2	Star Voltage L2-N Harmonic #2	Float [32b-LSW]	R		40869
V_L2N_H_3	Star Voltage L2-N Harmonic #3	Float [32b-LSW]	R		40871
V_L2N_H_4	Star Voltage L2-N Harmonic #4	Float [32b-LSW]	R		40873
V_L2N_H_5	Star Voltage L2-N Harmonic #5	Float [32b-LSW]	R		40875
V_L2N_H_6	Star Voltage L2-N Harmonic #6	Float [32b-LSW]	R		40877
V_L2N_H_7	Star Voltage L2-N Harmonic #7	Float [32b-LSW]	R		40879
V_L2N_H_8	Star Voltage L2-N Harmonic #8	Float [32b-LSW]	R		40881
V_L2N_H_9	Star Voltage L2-N Harmonic #9	Float [32b-LSW]	R		40883
V_L2N_H_10	Star Voltage L2-N Harmonic #10	Float [32b-LSW]	R		40885
V_L2N_H_11	Star Voltage L2-N Harmonic #11	Float [32b-LSW]	R		40887
V_L2N_H_12	Star Voltage L2-N Harmonic #12	Float [32b-LSW]	R		40889
V_L2N_H_13	Star Voltage L2-N Harmonic #13	Float [32b-LSW]	R		40891
V_L2N_H_14	Star Voltage L2-N Harmonic #14	Float [32b-LSW]	R		40893
V_L2N_H_15	Star Voltage L2-N Harmonic #15	Float [32b-LSW]	R		40895
V_L2N_H_16	Star Voltage L2-N Harmonic #16	Float [32b-LSW]	R		40897
V_L2N_H_17	Star Voltage L2-N Harmonic #17	Float [32b-LSW]	R		40899
V_L2N_H_18	Star Voltage L2-N Harmonic #18	Float [32b-LSW]	R		40901
V_L2N_H_19	Star Voltage L2-N Harmonic #19	Float [32b-LSW]	R		40903
V_L2N_H_20	Star Voltage L2-N Harmonic #20	Float [32b-LSW]	R		40905
V_L2N_H_21	Star Voltage L2-N Harmonic #21	Float [32b-LSW]	R		40907
V_L2N_H_22	Star Voltage L2-N Harmonic #22	Float [32b-LSW]	R		40909
V_L2N_H_23	Star Voltage L2-N Harmonic #23	Float [32b-LSW]	R		40911



Register Name	Description	Register Type	R/W	Default	Address Modbus
V_L2N_H_24	Star Voltage L2-N Harmonic #24	Float [32b-LSW]	R		40913
V_L2N_H_25	Star Voltage L2-N Harmonic #25	Float [32b-LSW]	R		40915
V_L2N_H_26	Star Voltage L2-N Harmonic #26	Float [32b-LSW]	R		40917
V_L2N_H_27	Star Voltage L2-N Harmonic #27	Float [32b-LSW]	R		40919
V_L2N_H_28	Star Voltage L2-N Harmonic #28	Float [32b-LSW]	R		40921
V_L2N_H_29	Star Voltage L2-N Harmonic #29	Float [32b-LSW]	R		40923
V_L2N_H_30	Star Voltage L2-N Harmonic #30	Float [32b-LSW]	R		40925
V_L2N_H_31	Star Voltage L2-N Harmonic #31	Float [32b-LSW]	R		40927
V_L2N_H_32	Star Voltage L2-N Harmonic #32	Float [32b-LSW]	R		40929
V_L2N_H_33	Star Voltage L2-N Harmonic #33	Float [32b-LSW]	R		40931
V_L2N_H_34	Star Voltage L2-N Harmonic #34	Float [32b-LSW]	R		40933
V_L2N_H_35	Star Voltage L2-N Harmonic #35	Float [32b-LSW]	R		40935
V_L2N_H_36	Star Voltage L2-N Harmonic #36	Float [32b-LSW]	R		40937
V_L2N_H_37	Star Voltage L2-N Harmonic #37	Float [32b-LSW]	R		40939
V_L2N_H_38	Star Voltage L2-N Harmonic #38	Float [32b-LSW]	R		40941
V_L2N_H_39	Star Voltage L2-N Harmonic #39	Float [32b-LSW]	R		40943
V_L2N_H_40	Star Voltage L2-N Harmonic #40	Float [32b-LSW]	R		40945
V_L2N_H_41	Star Voltage L2-N Harmonic #41	Float [32b-LSW]	R		40947
V_L2N_H_42	Star Voltage L2-N Harmonic #42	Float [32b-LSW]	R		40949
V_L2N_H_43	Star Voltage L2-N Harmonic #43	Float [32b-LSW]	R		40951
V_L2N_H_44	Star Voltage L2-N Harmonic #44	Float [32b-LSW]	R		40953
V_L2N_H_45	Star Voltage L2-N Harmonic #45	Float [32b-LSW]	R		40955
V_L2N_H_46	Star Voltage L2-N Harmonic #46	Float [32b-LSW]	R		40957
V_L2N_H_47	Star Voltage L2-N Harmonic #47	Float [32b-LSW]	R		40959
V_L2N_H_48	Star Voltage L2-N Harmonic #48	Float [32b-LSW]	R		40961
V_L2N_H_49	Star Voltage L2-N Harmonic #49	Float [32b-LSW]	R		40963
V_L2N_H_50	Star Voltage L2-N Harmonic #50	Float [32b-LSW]	R		40965
V_L2N_H_51	Star Voltage L2-N Harmonic #51	Float [32b-LSW]	R		40967
V_L2N_H_52	Star Voltage L2-N Harmonic #52	Float [32b-LSW]	R		40969
V_L2N_H_53	Star Voltage L2-N Harmonic #53	Float [32b-LSW]	R		40971
V_L2N_H_54	Star Voltage L2-N Harmonic #54	Float [32b-LSW]	R		40973
V_L2N_H_55	Star Voltage L2-N Harmonic #55	Float [32b-LSW]	R		40975
V_L2N_H_56	Star Voltage L2-N Harmonic #56	Float [32b-LSW]	R		40977
V_L2N_H_57	Star Voltage L2-N Harmonic #57	Float [32b-LSW]	R		40979
V_L2N_H_58	Star Voltage L2-N Harmonic #58	Float [32b-LSW]	R		40981
V_L2N_H_59	Star Voltage L2-N Harmonic #59	Float [32b-LSW]	R		40983
V_L2N_H_60	Star Voltage L2-N Harmonic #60	Float [32b-LSW]	R		40985
V_L2N_H_61	Star Voltage L2-N Harmonic #61	Float [32b-LSW]	R		40987
V_L2N_H_62	Star Voltage L2-N Harmonic #62	Float [32b-LSW]	R		40989
V_L2N_H_63	Star Voltage L2-N Harmonic #63	Float [32b-LSW]	R		40991
V_L3N_H_0	Star Voltage L3-N Harmonic #0	Float [32b-LSW]	R		40993
V_L3N_H_1	Star Voltage L3-N Harmonic #1	Float [32b-LSW]	R		40995
V_L3N_H_2	Star Voltage L3-N Harmonic #2	Float [32b-LSW]	R		40997
V_L3N_H_3	Star Voltage L3-N Harmonic #3	Float [32b-LSW]	R		40999
V_L3N_H_4	Star Voltage L3-N Harmonic #4	Float [32b-LSW]	R		41001
V_L3N_H_5	Star Voltage L3-N Harmonic #5	Float [32b-LSW]	R		41003
V_L3N_H_6	Star Voltage L3-N Harmonic #6	Float [32b-LSW]	R		41005
V_L3N_H_7	Star Voltage L3-N Harmonic #7	Float [32b-LSW]	R		41007
V_L3N_H_8	Star Voltage L3-N Harmonic #8	Float [32b-LSW]	R		41009
V_L3N_H_9	Star Voltage L3-N Harmonic #9	Float [32b-LSW]	R		41011
V_L3N_H_10	Star Voltage L3-N Harmonic #10	Float [32b-LSW]	R		41013
V_L3N_H_11	Star Voltage L3-N Harmonic #11	Float [32b-LSW]	R		41015
V_L3N_H_12	Star Voltage L3-N Harmonic #12	Float [32b-LSW]	R		41017
V_L3N_H_13	Star Voltage L3-N Harmonic #13	Float [32b-LSW]	R		41019
V_L3N_H_14	Star Voltage L3-N Harmonic #14	Float [32b-LSW]	R		41021
V_L3N_H_15	Star Voltage L3-N Harmonic #15	Float [32b-LSW]	R		41023
V_L3N_H_16	Star Voltage L3-N Harmonic #16	Float [32b-LSW]	R		41025
V_L3N_H_17	Star Voltage L3-N Harmonic #17	Float [32b-LSW]	R		41027
V_L3N_H_18	Star Voltage L3-N Harmonic #18	Float [32b-LSW]	R		41029
V_L3N_H_19	Star Voltage L3-N Harmonic #19	Float [32b-LSW]	R		41031
V_L3N_H_20	Star Voltage L3-N Harmonic #20	Float [32b-LSW]	R		41033
V_L3N_H_21	Star Voltage L3-N Harmonic #21	Float [32b-LSW]	R		41035
V_L3N_H_22	Star Voltage L3-N Harmonic #22	Float [32b-LSW]	R		41037



Register Name	Description	Register Type	R/W	Default	Address Modbus
V_L3N_H_23	Star Voltage L3-N Harmonic #23	Float [32b-LSW]	R		41039
V_L3N_H_24	Star Voltage L3-N Harmonic #24	Float [32b-LSW]	R		41041
V_L3N_H_25	Star Voltage L3-N Harmonic #25	Float [32b-LSW]	R		41043
V_L3N_H_26	Star Voltage L3-N Harmonic #26	Float [32b-LSW]	R		41045
V_L3N_H_27	Star Voltage L3-N Harmonic #27	Float [32b-LSW]	R		41047
V_L3N_H_28	Star Voltage L3-N Harmonic #28	Float [32b-LSW]	R		41049
V_L3N_H_29	Star Voltage L3-N Harmonic #29	Float [32b-LSW]	R		41051
V_L3N_H_30	Star Voltage L3-N Harmonic #30	Float [32b-LSW]	R		41053
V_L3N_H_31	Star Voltage L3-N Harmonic #31	Float [32b-LSW]	R		41055
V_L3N_H_32	Star Voltage L3-N Harmonic #32	Float [32b-LSW]	R		41057
V_L3N_H_33	Star Voltage L3-N Harmonic #33	Float [32b-LSW]	R		41059
V_L3N_H_34	Star Voltage L3-N Harmonic #34	Float [32b-LSW]	R		41061
V_L3N_H_35	Star Voltage L3-N Harmonic #35	Float [32b-LSW]	R		41063
V_L3N_H_36	Star Voltage L3-N Harmonic #36	Float [32b-LSW]	R		41065
V_L3N_H_37	Star Voltage L3-N Harmonic #37	Float [32b-LSW]	R		41067
V_L3N_H_38	Star Voltage L3-N Harmonic #38	Float [32b-LSW]	R		41069
V_L3N_H_39	Star Voltage L3-N Harmonic #39	Float [32b-LSW]	R		41071
V_L3N_H_40	Star Voltage L3-N Harmonic #40	Float [32b-LSW]	R		41073
V_L3N_H_41	Star Voltage L3-N Harmonic #41	Float [32b-LSW]	R		41075
V_L3N_H_42	Star Voltage L3-N Harmonic #42	Float [32b-LSW]	R		41077
V_L3N_H_43	Star Voltage L3-N Harmonic #43	Float [32b-LSW]	R		41079
V_L3N_H_44	Star Voltage L3-N Harmonic #44	Float [32b-LSW]	R		41081
V_L3N_H_45	Star Voltage L3-N Harmonic #45	Float [32b-LSW]	R		41083
V_L3N_H_46	Star Voltage L3-N Harmonic #46	Float [32b-LSW]	R		41085
V_L3N_H_47	Star Voltage L3-N Harmonic #47	Float [32b-LSW]	R		41087
V_L3N_H_48	Star Voltage L3-N Harmonic #48	Float [32b-LSW]	R		41089
V_L3N_H_49	Star Voltage L3-N Harmonic #49	Float [32b-LSW]	R		41091
V_L3N_H_50	Star Voltage L3-N Harmonic #50	Float [32b-LSW]	R		41093
V_L3N_H_51	Star Voltage L3-N Harmonic #51	Float [32b-LSW]	R		41095
V_L3N_H_52	Star Voltage L3-N Harmonic #52	Float [32b-LSW]	R		41097
V_L3N_H_53	Star Voltage L3-N Harmonic #53	Float [32b-LSW]	R		41099
V_L3N_H_54	Star Voltage L3-N Harmonic #54	Float [32b-LSW]	R		41101
V_L3N_H_55	Star Voltage L3-N Harmonic #55	Float [32b-LSW]	R		41103
V_L3N_H_56	Star Voltage L3-N Harmonic #56	Float [32b-LSW]	R		41105
V_L3N_H_57	Star Voltage L3-N Harmonic #57	Float [32b-LSW]	R		41107
V_L3N_H_58	Star Voltage L3-N Harmonic #58	Float [32b-LSW]	R		41109
V_L3N_H_59	Star Voltage L3-N Harmonic #59	Float [32b-LSW]	R		41111
V_L3N_H_60	Star Voltage L3-N Harmonic #60	Float [32b-LSW]	R		41113
V_L3N_H_61	Star Voltage L3-N Harmonic #61	Float [32b-LSW]	R		41115
V_L3N_H_62	Star Voltage L3-N Harmonic #62	Float [32b-LSW]	R		41117
V_L3N_H_63	Star Voltage L3-N Harmonic #63	Float [32b-LSW]	R		41119
V_L12_H_0	Line Voltage L1-L2 Harmonic #0	Float [32b-LSW]	R		41121
V_L12_H_1	Line Voltage L1-L2 Harmonic #1	Float [32b-LSW]	R		41123
V_L12_H_2	Line Voltage L1-L2 Harmonic #2	Float [32b-LSW]	R		41125
V_L12_H_3	Line Voltage L1-L2 Harmonic #3	Float [32b-LSW]	R		41127
V_L12_H_4	Line Voltage L1-L2 Harmonic #4	Float [32b-LSW]	R		41129
V_L12_H_5	Line Voltage L1-L2 Harmonic #5	Float [32b-LSW]	R		41131
V_L12_H_6	Line Voltage L1-L2 Harmonic #6	Float [32b-LSW]	R		41133
V_L12_H_7	Line Voltage L1-L2 Harmonic #7	Float [32b-LSW]	R		41135
V_L12_H_8	Line Voltage L1-L2 Harmonic #8	Float [32b-LSW]	R		41137
V_L12_H_9	Line Voltage L1-L2 Harmonic #9	Float [32b-LSW]	R		41139
V_L12_H_10	Line Voltage L1-L2 Harmonic #10	Float [32b-LSW]	R		41141
V_L12_H_11	Line Voltage L1-L2 Harmonic #11	Float [32b-LSW]	R		41143
V_L12_H_12	Line Voltage L1-L2 Harmonic #12	Float [32b-LSW]	R		41145
V_L12_H_13	Line Voltage L1-L2 Harmonic #13	Float [32b-LSW]	R		41147
V_L12_H_14	Line Voltage L1-L2 Harmonic #14	Float [32b-LSW]	R		41149
V_L12_H_15	Line Voltage L1-L2 Harmonic #15	Float [32b-LSW]	R		41151
V_L12_H_16	Line Voltage L1-L2 Harmonic #16	Float [32b-LSW]	R		41153
V_L12_H_17	Line Voltage L1-L2 Harmonic #17	Float [32b-LSW]	R		41155
V_L12_H_18	Line Voltage L1-L2 Harmonic #18	Float [32b-LSW]	R		41157
V_L12_H_19	Line Voltage L1-L2 Harmonic #19	Float [32b-LSW]	R		41159
V_L12_H_20	Line Voltage L1-L2 Harmonic #20	Float [32b-LSW]	R		41161
V_L12_H_21	Line Voltage L1-L2 Harmonic #21	Float [32b-LSW]	R		41163



Register Name	Description	Register Type	R/W	Default	Address Modbus
V_L12_H_22	Line Voltage L1-L2 Harmonic #22	Float [32b-LSW]	R		41165
V_L12_H_23	Line Voltage L1-L2 Harmonic #23	Float [32b-LSW]	R		41167
V_L12_H_24	Line Voltage L1-L2 Harmonic #24	Float [32b-LSW]	R		41169
V_L12_H_25	Line Voltage L1-L2 Harmonic #25	Float [32b-LSW]	R		41171
V_L12_H_26	Line Voltage L1-L2 Harmonic #26	Float [32b-LSW]	R		41173
V_L12_H_27	Line Voltage L1-L2 Harmonic #27	Float [32b-LSW]	R		41175
V_L12_H_28	Line Voltage L1-L2 Harmonic #28	Float [32b-LSW]	R		41177
V_L12_H_29	Line Voltage L1-L2 Harmonic #29	Float [32b-LSW]	R		41179
V_L12_H_30	Line Voltage L1-L2 Harmonic #30	Float [32b-LSW]	R		41181
V_L12_H_31	Line Voltage L1-L2 Harmonic #31	Float [32b-LSW]	R		41183
V_L12_H_32	Line Voltage L1-L2 Harmonic #32	Float [32b-LSW]	R		41185
V_L12_H_33	Line Voltage L1-L2 Harmonic #33	Float [32b-LSW]	R		41187
V_L12_H_34	Line Voltage L1-L2 Harmonic #34	Float [32b-LSW]	R		41189
V_L12_H_35	Line Voltage L1-L2 Harmonic #35	Float [32b-LSW]	R		41191
V_L12_H_36	Line Voltage L1-L2 Harmonic #36	Float [32b-LSW]	R		41193
V_L12_H_37	Line Voltage L1-L2 Harmonic #37	Float [32b-LSW]	R		41195
V_L12_H_38	Line Voltage L1-L2 Harmonic #38	Float [32b-LSW]	R		41197
V_L12_H_39	Line Voltage L1-L2 Harmonic #39	Float [32b-LSW]	R		41199
V_L12_H_40	Line Voltage L1-L2 Harmonic #40	Float [32b-LSW]	R		41201
V_L12_H_41	Line Voltage L1-L2 Harmonic #41	Float [32b-LSW]	R		41203
V_L12_H_42	Line Voltage L1-L2 Harmonic #42	Float [32b-LSW]	R		41205
V_L12_H_43	Line Voltage L1-L2 Harmonic #43	Float [32b-LSW]	R		41207
V_L12_H_44	Line Voltage L1-L2 Harmonic #44	Float [32b-LSW]	R		41209
V_L12_H_45	Line Voltage L1-L2 Harmonic #45	Float [32b-LSW]	R		41211
V_L12_H_46	Line Voltage L1-L2 Harmonic #46	Float [32b-LSW]	R		41213
V_L12_H_47	Line Voltage L1-L2 Harmonic #47	Float [32b-LSW]	R		41215
V_L12_H_48	Line Voltage L1-L2 Harmonic #48	Float [32b-LSW]	R		41217
V_L12_H_49	Line Voltage L1-L2 Harmonic #49	Float [32b-LSW]	R		41219
V_L12_H_50	Line Voltage L1-L2 Harmonic #50	Float [32b-LSW]	R		41221
V_L12_H_51	Line Voltage L1-L2 Harmonic #51	Float [32b-LSW]	R		41223
V_L12_H_52	Line Voltage L1-L2 Harmonic #52	Float [32b-LSW]	R		41225
V_L12_H_53	Line Voltage L1-L2 Harmonic #53	Float [32b-LSW]	R		41227
V_L12_H_54	Line Voltage L1-L2 Harmonic #54	Float [32b-LSW]	R		41229
V_L12_H_55	Line Voltage L1-L2 Harmonic #55	Float [32b-LSW]	R		41231
V_L12_H_56	Line Voltage L1-L2 Harmonic #56	Float [32b-LSW]	R		41233
V_L12_H_57	Line Voltage L1-L2 Harmonic #57	Float [32b-LSW]	R		41235
V_L12_H_58	Line Voltage L1-L2 Harmonic #58	Float [32b-LSW]	R		41237
V_L12_H_59	Line Voltage L1-L2 Harmonic #59	Float [32b-LSW]	R		41239
V_L12_H_60	Line Voltage L1-L2 Harmonic #60	Float [32b-LSW]	R		41241
V_L12_H_61	Line Voltage L1-L2 Harmonic #61	Float [32b-LSW]	R		41243
V_L12_H_62	Line Voltage L1-L2 Harmonic #62	Float [32b-LSW]	R		41245
V_L12_H_63	Line Voltage L1-L2 Harmonic #63	Float [32b-LSW]	R		41247
V_L23_H_0	Line Voltage L2-L3 Harmonic #0	Float [32b-LSW]	R		41249
V_L23_H_1	Line Voltage L2-L3 Harmonic #1	Float [32b-LSW]	R		41251
V_L23_H_2	Line Voltage L2-L3 Harmonic #2	Float [32b-LSW]	R		41253
V_L23_H_3	Line Voltage L2-L3 Harmonic #3	Float [32b-LSW]	R		41255
V_L23_H_4	Line Voltage L2-L3 Harmonic #4	Float [32b-LSW]	R		41257
V_L23_H_5	Line Voltage L2-L3 Harmonic #5	Float [32b-LSW]	R		41259
V_L23_H_6	Line Voltage L2-L3 Harmonic #6	Float [32b-LSW]	R		41261
V_L23_H_7	Line Voltage L2-L3 Harmonic #7	Float [32b-LSW]	R		41263
V_L23_H_8	Line Voltage L2-L3 Harmonic #8	Float [32b-LSW]	R		41265
V_L23_H_9	Line Voltage L2-L3 Harmonic #9	Float [32b-LSW]	R		41267
V_L23_H_10	Line Voltage L2-L3 Harmonic #10	Float [32b-LSW]	R		41269
V_L23_H_11	Line Voltage L2-L3 Harmonic #11	Float [32b-LSW]	R		41271
V_L23_H_12	Line Voltage L2-L3 Harmonic #12	Float [32b-LSW]	R		41273
V_L23_H_13	Line Voltage L2-L3 Harmonic #13	Float [32b-LSW]	R		41275
V_L23_H_14	Line Voltage L2-L3 Harmonic #14	Float [32b-LSW]	R		41277
V_L23_H_15	Line Voltage L2-L3 Harmonic #15	Float [32b-LSW]	R		41279
V_L23_H_16	Line Voltage L2-L3 Harmonic #16	Float [32b-LSW]	R		41281
V_L23_H_17	Line Voltage L2-L3 Harmonic #17	Float [32b-LSW]	R		41283
V_L23_H_18	Line Voltage L2-L3 Harmonic #18	Float [32b-LSW]	R		41285
V_L23_H_19	Line Voltage L2-L3 Harmonic #19	Float [32b-LSW]	R		41287
V_L23_H_20	Line Voltage L2-L3 Harmonic #20	Float [32b-LSW]	R		41289



Register Name	Description	Register Type	R/W	Default	Address Modbus
V_L23_H_21	Line Voltage L2-L3 Harmonic #21	Float [32b-LSW]	R		41291
V_L23_H_22	Line Voltage L2-L3 Harmonic #22	Float [32b-LSW]	R		41293
V_L23_H_23	Line Voltage L2-L3 Harmonic #23	Float [32b-LSW]	R		41295
V_L23_H_24	Line Voltage L2-L3 Harmonic #24	Float [32b-LSW]	R		41297
V_L23_H_25	Line Voltage L2-L3 Harmonic #25	Float [32b-LSW]	R		41299
V_L23_H_26	Line Voltage L2-L3 Harmonic #26	Float [32b-LSW]	R		41301
V_L23_H_27	Line Voltage L2-L3 Harmonic #27	Float [32b-LSW]	R		41303
V_L23_H_28	Line Voltage L2-L3 Harmonic #28	Float [32b-LSW]	R		41305
V_L23_H_29	Line Voltage L2-L3 Harmonic #29	Float [32b-LSW]	R		41307
V_L23_H_30	Line Voltage L2-L3 Harmonic #30	Float [32b-LSW]	R		41309
V_L23_H_31	Line Voltage L2-L3 Harmonic #31	Float [32b-LSW]	R		41311
V_L23_H_32	Line Voltage L2-L3 Harmonic #32	Float [32b-LSW]	R		41313
V_L23_H_33	Line Voltage L2-L3 Harmonic #33	Float [32b-LSW]	R		41315
V_L23_H_34	Line Voltage L2-L3 Harmonic #34	Float [32b-LSW]	R		41317
V_L23_H_35	Line Voltage L2-L3 Harmonic #35	Float [32b-LSW]	R		41319
V_L23_H_36	Line Voltage L2-L3 Harmonic #36	Float [32b-LSW]	R		41321
V_L23_H_37	Line Voltage L2-L3 Harmonic #37	Float [32b-LSW]	R		41323
V_L23_H_38	Line Voltage L2-L3 Harmonic #38	Float [32b-LSW]	R		41325
V_L23_H_39	Line Voltage L2-L3 Harmonic #39	Float [32b-LSW]	R		41327
V_L23_H_40	Line Voltage L2-L3 Harmonic #40	Float [32b-LSW]	R		41329
V_L23_H_41	Line Voltage L2-L3 Harmonic #41	Float [32b-LSW]	R		41331
V_L23_H_42	Line Voltage L2-L3 Harmonic #42	Float [32b-LSW]	R		41333
V_L23_H_43	Line Voltage L2-L3 Harmonic #43	Float [32b-LSW]	R		41335
V_L23_H_44	Line Voltage L2-L3 Harmonic #44	Float [32b-LSW]	R		41337
V_L23_H_45	Line Voltage L2-L3 Harmonic #45	Float [32b-LSW]	R		41339
V_L23_H_46	Line Voltage L2-L3 Harmonic #46	Float [32b-LSW]	R		41341
V_L23_H_47	Line Voltage L2-L3 Harmonic #47	Float [32b-LSW]	R		41343
V_L23_H_48	Line Voltage L2-L3 Harmonic #48	Float [32b-LSW]	R		41345
V_L23_H_49	Line Voltage L2-L3 Harmonic #49	Float [32b-LSW]	R		41347
V_L23_H_50	Line Voltage L2-L3 Harmonic #50	Float [32b-LSW]	R		41349
V_L23_H_51	Line Voltage L2-L3 Harmonic #51	Float [32b-LSW]	R		41351
V_L23_H_52	Line Voltage L2-L3 Harmonic #52	Float [32b-LSW]	R		41353
V_L23_H_53	Line Voltage L2-L3 Harmonic #53	Float [32b-LSW]	R		41355
V_L23_H_54	Line Voltage L2-L3 Harmonic #54	Float [32b-LSW]	R		41357
V_L23_H_55	Line Voltage L2-L3 Harmonic #55	Float [32b-LSW]	R		41359
V_L23_H_56	Line Voltage L2-L3 Harmonic #56	Float [32b-LSW]	R		41361
V_L23_H_57	Line Voltage L2-L3 Harmonic #57	Float [32b-LSW]	R		41363
V_L23_H_58	Line Voltage L2-L3 Harmonic #58	Float [32b-LSW]	R		41365
V_L23_H_59	Line Voltage L2-L3 Harmonic #59	Float [32b-LSW]	R		41367
V_L23_H_60	Line Voltage L2-L3 Harmonic #60	Float [32b-LSW]	R		41369
V_L23_H_61	Line Voltage L2-L3 Harmonic #61	Float [32b-LSW]	R		41371
V_L23_H_62	Line Voltage L2-L3 Harmonic #62	Float [32b-LSW]	R		41373
V_L23_H_63	Line Voltage L2-L3 Harmonic #63	Float [32b-LSW]	R		41375
V_L31_H_0	Line Voltage L3-L1 Harmonic #0	Float [32b-LSW]	R		41377
V_L31_H_1	Line Voltage L3-L1 Harmonic #1	Float [32b-LSW]	R		41379
V_L31_H_2	Line Voltage L3-L1 Harmonic #2	Float [32b-LSW]	R		41381
V_L31_H_3	Line Voltage L3-L1 Harmonic #3	Float [32b-LSW]	R		41383
V_L31_H_4	Line Voltage L3-L1 Harmonic #4	Float [32b-LSW]	R		41385
V_L31_H_5	Line Voltage L3-L1 Harmonic #5	Float [32b-LSW]	R		41387
V_L31_H_6	Line Voltage L3-L1 Harmonic #6	Float [32b-LSW]	R		41389
V_L31_H_7	Line Voltage L3-L1 Harmonic #7	Float [32b-LSW]	R		41391
V_L31_H_8	Line Voltage L3-L1 Harmonic #8	Float [32b-LSW]	R		41393
V_L31_H_9	Line Voltage L3-L1 Harmonic #9	Float [32b-LSW]	R		41395
V_L31_H_10	Line Voltage L3-L1 Harmonic #10	Float [32b-LSW]	R		41397
V_L31_H_11	Line Voltage L3-L1 Harmonic #11	Float [32b-LSW]	R		41399
V_L31_H_12	Line Voltage L3-L1 Harmonic #12	Float [32b-LSW]	R		41401
V_L31_H_13	Line Voltage L3-L1 Harmonic #13	Float [32b-LSW]	R		41403
V_L31_H_14	Line Voltage L3-L1 Harmonic #14	Float [32b-LSW]	R		41405
V_L31_H_15	Line Voltage L3-L1 Harmonic #15	Float [32b-LSW]	R		41407
V_L31_H_16	Line Voltage L3-L1 Harmonic #16	Float [32b-LSW]	R		41409
V_L31_H_17	Line Voltage L3-L1 Harmonic #17	Float [32b-LSW]	R		41411
V_L31_H_18	Line Voltage L3-L1 Harmonic #18	Float [32b-LSW]	R		41413
V_L31_H_19	Line Voltage L3-L1 Harmonic #19	Float [32b-LSW]	R		41415



Register Name	Description	Register Type	R/W	Default	Address Modbus
V_L31_H_20	Line Voltage L3-L1 Harmonic #20	Float [32b-LSW]	R		41417
V_L31_H_21	Line Voltage L3-L1 Harmonic #21	Float [32b-LSW]	R		41419
V_L31_H_22	Line Voltage L3-L1 Harmonic #22	Float [32b-LSW]	R		41421
V_L31_H_23	Line Voltage L3-L1 Harmonic #23	Float [32b-LSW]	R		41423
V_L31_H_24	Line Voltage L3-L1 Harmonic #24	Float [32b-LSW]	R		41425
V_L31_H_25	Line Voltage L3-L1 Harmonic #25	Float [32b-LSW]	R		41427
V_L31_H_26	Line Voltage L3-L1 Harmonic #26	Float [32b-LSW]	R		41429
V_L31_H_27	Line Voltage L3-L1 Harmonic #27	Float [32b-LSW]	R		41431
V_L31_H_28	Line Voltage L3-L1 Harmonic #28	Float [32b-LSW]	R		41433
V_L31_H_29	Line Voltage L3-L1 Harmonic #29	Float [32b-LSW]	R		41435
V_L31_H_30	Line Voltage L3-L1 Harmonic #30	Float [32b-LSW]	R		41437
V_L31_H_31	Line Voltage L3-L1 Harmonic #31	Float [32b-LSW]	R		41439
V_L31_H_32	Line Voltage L3-L1 Harmonic #32	Float [32b-LSW]	R		41441
V_L31_H_33	Line Voltage L3-L1 Harmonic #33	Float [32b-LSW]	R		41443
V_L31_H_34	Line Voltage L3-L1 Harmonic #34	Float [32b-LSW]	R		41445
V_L31_H_35	Line Voltage L3-L1 Harmonic #35	Float [32b-LSW]	R		41447
V_L31_H_36	Line Voltage L3-L1 Harmonic #36	Float [32b-LSW]	R		41449
V_L31_H_37	Line Voltage L3-L1 Harmonic #37	Float [32b-LSW]	R		41451
V_L31_H_38	Line Voltage L3-L1 Harmonic #38	Float [32b-LSW]	R		41453
V_L31_H_39	Line Voltage L3-L1 Harmonic #39	Float [32b-LSW]	R		41455
V_L31_H_40	Line Voltage L3-L1 Harmonic #40	Float [32b-LSW]	R		41457
V_L31_H_41	Line Voltage L3-L1 Harmonic #41	Float [32b-LSW]	R		41459
V_L31_H_42	Line Voltage L3-L1 Harmonic #42	Float [32b-LSW]	R		41461
V_L31_H_43	Line Voltage L3-L1 Harmonic #43	Float [32b-LSW]	R		41463
V_L31_H_44	Line Voltage L3-L1 Harmonic #44	Float [32b-LSW]	R		41465
V_L31_H_45	Line Voltage L3-L1 Harmonic #45	Float [32b-LSW]	R		41467
V_L31_H_46	Line Voltage L3-L1 Harmonic #46	Float [32b-LSW]	R		41469
V_L31_H_47	Line Voltage L3-L1 Harmonic #47	Float [32b-LSW]	R		41471
V_L31_H_48	Line Voltage L3-L1 Harmonic #48	Float [32b-LSW]	R		41473
V_L31_H_49	Line Voltage L3-L1 Harmonic #49	Float [32b-LSW]	R		41475
V_L31_H_50	Line Voltage L3-L1 Harmonic #50	Float [32b-LSW]	R		41477
V_L31_H_51	Line Voltage L3-L1 Harmonic #51	Float [32b-LSW]	R		41479
V_L31_H_52	Line Voltage L3-L1 Harmonic #52	Float [32b-LSW]	R		41481
V_L31_H_53	Line Voltage L3-L1 Harmonic #53	Float [32b-LSW]	R		41483
V_L31_H_54	Line Voltage L3-L1 Harmonic #54	Float [32b-LSW]	R		41485
V_L31_H_55	Line Voltage L3-L1 Harmonic #55	Float [32b-LSW]	R		41487
V_L31_H_56	Line Voltage L3-L1 Harmonic #56	Float [32b-LSW]	R		41489
V_L31_H_57	Line Voltage L3-L1 Harmonic #57	Float [32b-LSW]	R		41491
V_L31_H_58	Line Voltage L3-L1 Harmonic #58	Float [32b-LSW]	R		41493
V_L31_H_59	Line Voltage L3-L1 Harmonic #59	Float [32b-LSW]	R		41495
V_L31_H_60	Line Voltage L3-L1 Harmonic #60	Float [32b-LSW]	R		41497
V_L31_H_61	Line Voltage L3-L1 Harmonic #61	Float [32b-LSW]	R		41499
V_L31_H_62	Line Voltage L3-L1 Harmonic #62	Float [32b-LSW]	R		41501
V_L31_H_63	Line Voltage L3-L1 Harmonic #63	Float [32b-LSW]	R		41503
I_L1_H_0	Line Current L1 Harmonic #0	Float [32b-LSW]	R		41505
I_L1_H_1	Line Current L1 Harmonic #1	Float [32b-LSW]	R		41507
I_L1_H_2	Line Current L1 Harmonic #2	Float [32b-LSW]	R		41509
I_L1_H_3	Line Current L1 Harmonic #3	Float [32b-LSW]	R		41511
I_L1_H_4	Line Current L1 Harmonic #4	Float [32b-LSW]	R		41513
I_L1_H_5	Line Current L1 Harmonic #5	Float [32b-LSW]	R		41515
I_L1_H_6	Line Current L1 Harmonic #6	Float [32b-LSW]	R		41517
I_L1_H_7	Line Current L1 Harmonic #7	Float [32b-LSW]	R		41519
I_L1_H_8	Line Current L1 Harmonic #8	Float [32b-LSW]	R		41521
I_L1_H_9	Line Current L1 Harmonic #9	Float [32b-LSW]	R		41523
I_L1_H_10	Line Current L1 Harmonic #10	Float [32b-LSW]	R		41525
I_L1_H_11	Line Current L1 Harmonic #11	Float [32b-LSW]	R		41527
I_L1_H_12	Line Current L1 Harmonic #12	Float [32b-LSW]	R		41529
I_L1_H_13	Line Current L1 Harmonic #13	Float [32b-LSW]	R		41531
I_L1_H_14	Line Current L1 Harmonic #14	Float [32b-LSW]	R		41533
I_L1_H_15	Line Current L1 Harmonic #15	Float [32b-LSW]	R		41535
I_L1_H_16	Line Current L1 Harmonic #16	Float [32b-LSW]	R		41537
I_L1_H_17	Line Current L1 Harmonic #17	Float [32b-LSW]	R		41539
I_L1_H_18	Line Current L1 Harmonic #18	Float [32b-LSW]	R		41541



Register Name	Description	Register Type	R/W	Default	Address Modbus
I_L1_H_19	Line Current L1 Harmonic #19	Float [32b-LSW]	R		41543
I_L1_H_20	Line Current L1 Harmonic #20	Float [32b-LSW]	R		41545
I_L1_H_21	Line Current L1 Harmonic #21	Float [32b-LSW]	R		41547
I_L1_H_22	Line Current L1 Harmonic #22	Float [32b-LSW]	R		41549
I_L1_H_23	Line Current L1 Harmonic #23	Float [32b-LSW]	R		41551
I_L1_H_24	Line Current L1 Harmonic #24	Float [32b-LSW]	R		41553
I_L1_H_25	Line Current L1 Harmonic #25	Float [32b-LSW]	R		41555
I_L1_H_26	Line Current L1 Harmonic #26	Float [32b-LSW]	R		41557
I_L1_H_27	Line Current L1 Harmonic #27	Float [32b-LSW]	R		41559
I_L1_H_28	Line Current L1 Harmonic #28	Float [32b-LSW]	R		41561
I_L1_H_29	Line Current L1 Harmonic #29	Float [32b-LSW]	R		41563
I_L1_H_30	Line Current L1 Harmonic #30	Float [32b-LSW]	R		41565
I_L1_H_31	Line Current L1 Harmonic #31	Float [32b-LSW]	R		41567
I_L1_H_32	Line Current L1 Harmonic #32	Float [32b-LSW]	R		41569
I_L1_H_33	Line Current L1 Harmonic #33	Float [32b-LSW]	R		41571
I_L1_H_34	Line Current L1 Harmonic #34	Float [32b-LSW]	R		41573
I_L1_H_35	Line Current L1 Harmonic #35	Float [32b-LSW]	R		41575
I_L1_H_36	Line Current L1 Harmonic #36	Float [32b-LSW]	R		41577
I_L1_H_37	Line Current L1 Harmonic #37	Float [32b-LSW]	R		41579
I_L1_H_38	Line Current L1 Harmonic #38	Float [32b-LSW]	R		41581
I_L1_H_39	Line Current L1 Harmonic #39	Float [32b-LSW]	R		41583
I_L1_H_40	Line Current L1 Harmonic #40	Float [32b-LSW]	R		41585
I_L1_H_41	Line Current L1 Harmonic #41	Float [32b-LSW]	R		41587
I_L1_H_42	Line Current L1 Harmonic #42	Float [32b-LSW]	R		41589
I_L1_H_43	Line Current L1 Harmonic #43	Float [32b-LSW]	R		41591
I_L1_H_44	Line Current L1 Harmonic #44	Float [32b-LSW]	R		41593
I_L1_H_45	Line Current L1 Harmonic #45	Float [32b-LSW]	R		41595
I_L1_H_46	Line Current L1 Harmonic #46	Float [32b-LSW]	R		41597
I_L1_H_47	Line Current L1 Harmonic #47	Float [32b-LSW]	R		41599
I_L1_H_48	Line Current L1 Harmonic #48	Float [32b-LSW]	R		41601
I_L1_H_49	Line Current L1 Harmonic #49	Float [32b-LSW]	R		41603
I_L1_H_50	Line Current L1 Harmonic #50	Float [32b-LSW]	R		41605
I_L1_H_51	Line Current L1 Harmonic #51	Float [32b-LSW]	R		41607
I_L1_H_52	Line Current L1 Harmonic #52	Float [32b-LSW]	R		41609
I_L1_H_53	Line Current L1 Harmonic #53	Float [32b-LSW]	R		41611
I_L1_H_54	Line Current L1 Harmonic #54	Float [32b-LSW]	R		41613
I_L1_H_55	Line Current L1 Harmonic #55	Float [32b-LSW]	R		41615
I_L1_H_56	Line Current L1 Harmonic #56	Float [32b-LSW]	R		41617
I_L1_H_57	Line Current L1 Harmonic #57	Float [32b-LSW]	R		41619
I_L1_H_58	Line Current L1 Harmonic #58	Float [32b-LSW]	R		41621
I_L1_H_59	Line Current L1 Harmonic #59	Float [32b-LSW]	R		41623
I_L1_H_60	Line Current L1 Harmonic #60	Float [32b-LSW]	R		41625
I_L1_H_61	Line Current L1 Harmonic #61	Float [32b-LSW]	R		41627
I_L1_H_62	Line Current L1 Harmonic #62	Float [32b-LSW]	R		41629
I_L1_H_63	Line Current L1 Harmonic #63	Float [32b-LSW]	R		41631
I_L2_H_0	Line Current L2 Harmonic #0	Float [32b-LSW]	R		41633
I_L2_H_1	Line Current L2 Harmonic #1	Float [32b-LSW]	R		41635
I_L2_H_2	Line Current L2 Harmonic #2	Float [32b-LSW]	R		41637
I_L2_H_3	Line Current L2 Harmonic #3	Float [32b-LSW]	R		41639
I_L2_H_4	Line Current L2 Harmonic #4	Float [32b-LSW]	R		41641
I_L2_H_5	Line Current L2 Harmonic #5	Float [32b-LSW]	R		41643
I_L2_H_6	Line Current L2 Harmonic #6	Float [32b-LSW]	R		41645
I_L2_H_7	Line Current L2 Harmonic #7	Float [32b-LSW]	R		41647
I_L2_H_8	Line Current L2 Harmonic #8	Float [32b-LSW]	R		41649
I_L2_H_9	Line Current L2 Harmonic #9	Float [32b-LSW]	R		41651
I_L2_H_10	Line Current L2 Harmonic #10	Float [32b-LSW]	R		41653
I_L2_H_11	Line Current L2 Harmonic #11	Float [32b-LSW]	R		41655
I_L2_H_12	Line Current L2 Harmonic #12	Float [32b-LSW]	R		41657
I_L2_H_13	Line Current L2 Harmonic #13	Float [32b-LSW]	R		41659
I_L2_H_14	Line Current L2 Harmonic #14	Float [32b-LSW]	R		41661
I_L2_H_15	Line Current L2 Harmonic #15	Float [32b-LSW]	R		41663
I_L2_H_16	Line Current L2 Harmonic #16	Float [32b-LSW]	R		41665
I_L2_H_17	Line Current L2 Harmonic #17	Float [32b-LSW]	R		41667



Register Name	Description	Register Type	R/W	Default	Address Modbus
I_L2_H_18	Line Current L2 Harmonic #18	Float [32b-LSW]	R		41669
I_L2_H_19	Line Current L2 Harmonic #19	Float [32b-LSW]	R		41671
I_L2_H_20	Line Current L2 Harmonic #20	Float [32b-LSW]	R		41673
I_L2_H_21	Line Current L2 Harmonic #21	Float [32b-LSW]	R		41675
I_L2_H_22	Line Current L2 Harmonic #22	Float [32b-LSW]	R		41677
I_L2_H_23	Line Current L2 Harmonic #23	Float [32b-LSW]	R		41679
I_L2_H_24	Line Current L2 Harmonic #24	Float [32b-LSW]	R		41681
I_L2_H_25	Line Current L2 Harmonic #25	Float [32b-LSW]	R		41683
I_L2_H_26	Line Current L2 Harmonic #26	Float [32b-LSW]	R		41685
I_L2_H_27	Line Current L2 Harmonic #27	Float [32b-LSW]	R		41687
I_L2_H_28	Line Current L2 Harmonic #28	Float [32b-LSW]	R		41689
I_L2_H_29	Line Current L2 Harmonic #29	Float [32b-LSW]	R		41691
I_L2_H_30	Line Current L2 Harmonic #30	Float [32b-LSW]	R		41693
I_L2_H_31	Line Current L2 Harmonic #31	Float [32b-LSW]	R		41695
I_L2_H_32	Line Current L2 Harmonic #32	Float [32b-LSW]	R		41697
I_L2_H_33	Line Current L2 Harmonic #33	Float [32b-LSW]	R		41699
I_L2_H_34	Line Current L2 Harmonic #34	Float [32b-LSW]	R		41701
I_L2_H_35	Line Current L2 Harmonic #35	Float [32b-LSW]	R		41703
I_L2_H_36	Line Current L2 Harmonic #36	Float [32b-LSW]	R		41705
I_L2_H_37	Line Current L2 Harmonic #37	Float [32b-LSW]	R		41707
I_L2_H_38	Line Current L2 Harmonic #38	Float [32b-LSW]	R		41709
I_L2_H_39	Line Current L2 Harmonic #39	Float [32b-LSW]	R		41711
I_L2_H_40	Line Current L2 Harmonic #40	Float [32b-LSW]	R		41713
I_L2_H_41	Line Current L2 Harmonic #41	Float [32b-LSW]	R		41715
I_L2_H_42	Line Current L2 Harmonic #42	Float [32b-LSW]	R		41717
I_L2_H_43	Line Current L2 Harmonic #43	Float [32b-LSW]	R		41719
I_L2_H_44	Line Current L2 Harmonic #44	Float [32b-LSW]	R		41721
I_L2_H_45	Line Current L2 Harmonic #45	Float [32b-LSW]	R		41723
I_L2_H_46	Line Current L2 Harmonic #46	Float [32b-LSW]	R		41725
I_L2_H_47	Line Current L2 Harmonic #47	Float [32b-LSW]	R		41727
I_L2_H_48	Line Current L2 Harmonic #48	Float [32b-LSW]	R		41729
I_L2_H_49	Line Current L2 Harmonic #49	Float [32b-LSW]	R		41731
I_L2_H_50	Line Current L2 Harmonic #50	Float [32b-LSW]	R		41733
I_L2_H_51	Line Current L2 Harmonic #51	Float [32b-LSW]	R		41735
I_L2_H_52	Line Current L2 Harmonic #52	Float [32b-LSW]	R		41737
I_L2_H_53	Line Current L2 Harmonic #53	Float [32b-LSW]	R		41739
I_L2_H_54	Line Current L2 Harmonic #54	Float [32b-LSW]	R		41741
I_L2_H_55	Line Current L2 Harmonic #55	Float [32b-LSW]	R		41743
I_L2_H_56	Line Current L2 Harmonic #56	Float [32b-LSW]	R		41745
I_L2_H_57	Line Current L2 Harmonic #57	Float [32b-LSW]	R		41747
I_L2_H_58	Line Current L2 Harmonic #58	Float [32b-LSW]	R		41749
I_L2_H_59	Line Current L2 Harmonic #59	Float [32b-LSW]	R		41751
I_L2_H_60	Line Current L2 Harmonic #60	Float [32b-LSW]	R		41753
I_L2_H_61	Line Current L2 Harmonic #61	Float [32b-LSW]	R		41755
I_L2_H_62	Line Current L2 Harmonic #62	Float [32b-LSW]	R		41757
I_L2_H_63	Line Current L2 Harmonic #63	Float [32b-LSW]	R		41759
I_L3_H_0	Line Current L3 Harmonic #0	Float [32b-LSW]	R		41761
I_L3_H_1	Line Current L3 Harmonic #1	Float [32b-LSW]	R		41763
I_L3_H_2	Line Current L3 Harmonic #2	Float [32b-LSW]	R		41765
I_L3_H_3	Line Current L3 Harmonic #3	Float [32b-LSW]	R		41767
I_L3_H_4	Line Current L3 Harmonic #4	Float [32b-LSW]	R		41769
I_L3_H_5	Line Current L3 Harmonic #5	Float [32b-LSW]	R		41771
I_L3_H_6	Line Current L3 Harmonic #6	Float [32b-LSW]	R		41773
I_L3_H_7	Line Current L3 Harmonic #7	Float [32b-LSW]	R		41775
I_L3_H_8	Line Current L3 Harmonic #8	Float [32b-LSW]	R		41777
I_L3_H_9	Line Current L3 Harmonic #9	Float [32b-LSW]	R		41779
I_L3_H_10	Line Current L3 Harmonic #10	Float [32b-LSW]	R		41781
I_L3_H_11	Line Current L3 Harmonic #11	Float [32b-LSW]	R		41783
I_L3_H_12	Line Current L3 Harmonic #12	Float [32b-LSW]	R		41785
I_L3_H_13	Line Current L3 Harmonic #13	Float [32b-LSW]	R		41787
I_L3_H_14	Line Current L3 Harmonic #14	Float [32b-LSW]	R		41789
I_L3_H_15	Line Current L3 Harmonic #15	Float [32b-LSW]	R		41791
I_L3_H_16	Line Current L3 Harmonic #16	Float [32b-LSW]	R		41793



Register Name	Description	Register Type	R/W	Default	Address Modbus
I_L3_H_17	Line Current L3 Harmonic #17	Float [32b-LSW]	R		41795
I_L3_H_18	Line Current L3 Harmonic #18	Float [32b-LSW]	R		41797
I_L3_H_19	Line Current L3 Harmonic #19	Float [32b-LSW]	R		41799
I_L3_H_20	Line Current L3 Harmonic #20	Float [32b-LSW]	R		41801
I_L3_H_21	Line Current L3 Harmonic #21	Float [32b-LSW]	R		41803
I_L3_H_22	Line Current L3 Harmonic #22	Float [32b-LSW]	R		41805
I_L3_H_23	Line Current L3 Harmonic #23	Float [32b-LSW]	R		41807
I_L3_H_24	Line Current L3 Harmonic #24	Float [32b-LSW]	R		41809
I_L3_H_25	Line Current L3 Harmonic #25	Float [32b-LSW]	R		41811
I_L3_H_26	Line Current L3 Harmonic #26	Float [32b-LSW]	R		41813
I_L3_H_27	Line Current L3 Harmonic #27	Float [32b-LSW]	R		41815
I_L3_H_28	Line Current L3 Harmonic #28	Float [32b-LSW]	R		41817
I_L3_H_29	Line Current L3 Harmonic #29	Float [32b-LSW]	R		41819
I_L3_H_30	Line Current L3 Harmonic #30	Float [32b-LSW]	R		41821
I_L3_H_31	Line Current L3 Harmonic #31	Float [32b-LSW]	R		41823
I_L3_H_32	Line Current L3 Harmonic #32	Float [32b-LSW]	R		41825
I_L3_H_33	Line Current L3 Harmonic #33	Float [32b-LSW]	R		41827
I_L3_H_34	Line Current L3 Harmonic #34	Float [32b-LSW]	R		41829
I_L3_H_35	Line Current L3 Harmonic #35	Float [32b-LSW]	R		41831
I_L3_H_36	Line Current L3 Harmonic #36	Float [32b-LSW]	R		41833
I_L3_H_37	Line Current L3 Harmonic #37	Float [32b-LSW]	R		41835
I_L3_H_38	Line Current L3 Harmonic #38	Float [32b-LSW]	R		41837
I_L3_H_39	Line Current L3 Harmonic #39	Float [32b-LSW]	R		41839
I_L3_H_40	Line Current L3 Harmonic #40	Float [32b-LSW]	R		41841
I_L3_H_41	Line Current L3 Harmonic #41	Float [32b-LSW]	R		41843
I_L3_H_42	Line Current L3 Harmonic #42	Float [32b-LSW]	R		41845
I_L3_H_43	Line Current L3 Harmonic #43	Float [32b-LSW]	R		41847
I_L3_H_44	Line Current L3 Harmonic #44	Float [32b-LSW]	R		41849
I_L3_H_45	Line Current L3 Harmonic #45	Float [32b-LSW]	R		41851
I_L3_H_46	Line Current L3 Harmonic #46	Float [32b-LSW]	R		41853
I_L3_H_47	Line Current L3 Harmonic #47	Float [32b-LSW]	R		41855
I_L3_H_48	Line Current L3 Harmonic #48	Float [32b-LSW]	R		41857
I_L3_H_49	Line Current L3 Harmonic #49	Float [32b-LSW]	R		41859
I_L3_H_50	Line Current L3 Harmonic #50	Float [32b-LSW]	R		41861
I_L3_H_51	Line Current L3 Harmonic #51	Float [32b-LSW]	R		41863
I_L3_H_52	Line Current L3 Harmonic #52	Float [32b-LSW]	R		41865
I_L3_H_53	Line Current L3 Harmonic #53	Float [32b-LSW]	R		41867
I_L3_H_54	Line Current L3 Harmonic #54	Float [32b-LSW]	R		41869
I_L3_H_55	Line Current L3 Harmonic #55	Float [32b-LSW]	R		41871
I_L3_H_56	Line Current L3 Harmonic #56	Float [32b-LSW]	R		41873
I_L3_H_57	Line Current L3 Harmonic #57	Float [32b-LSW]	R		41875
I_L3_H_58	Line Current L3 Harmonic #58	Float [32b-LSW]	R		41877
I_L3_H_59	Line Current L3 Harmonic #59	Float [32b-LSW]	R		41879
I_L3_H_60	Line Current L3 Harmonic #60	Float [32b-LSW]	R		41881
I_L3_H_61	Line Current L3 Harmonic #61	Float [32b-LSW]	R		41883
I_L3_H_62	Line Current L3 Harmonic #62	Float [32b-LSW]	R		41885
I_L3_H_63	Line Current L3 Harmonic #63	Float [32b-LSW]	R		41887
I_N_H_0	Line Current N Harmonic #0	Float [32b-LSW]	R		41889
I_N_H_1	Line Current N Harmonic #1	Float [32b-LSW]	R		41891
I_N_H_2	Line Current N Harmonic #2	Float [32b-LSW]	R		41893
I_N_H_3	Line Current N Harmonic #3	Float [32b-LSW]	R		41895
I_N_H_4	Line Current N Harmonic #4	Float [32b-LSW]	R		41897
I_N_H_5	Line Current N Harmonic #5	Float [32b-LSW]	R		41899
I_N_H_6	Line Current N Harmonic #6	Float [32b-LSW]	R		41901
I_N_H_7	Line Current N Harmonic #7	Float [32b-LSW]	R		41903
I_N_H_8	Line Current N Harmonic #8	Float [32b-LSW]	R		41905
I_N_H_9	Line Current N Harmonic #9	Float [32b-LSW]	R		41907
I_N_H_10	Line Current N Harmonic #10	Float [32b-LSW]	R		41909
I_N_H_11	Line Current N Harmonic #11	Float [32b-LSW]	R		41911
I_N_H_12	Line Current N Harmonic #12	Float [32b-LSW]	R		41913
I_N_H_13	Line Current N Harmonic #13	Float [32b-LSW]	R		41915
I_N_H_14	Line Current N Harmonic #14	Float [32b-LSW]	R		41917
I_N_H_15	Line Current N Harmonic #15	Float [32b-LSW]	R		41919



Register Name	Description	Register Type	R/W	Default	Address Modbus
I_N_H_16	Line Current N Harmonic #16	Float [32b-LSW]	R		41921
I_N_H_17	Line Current N Harmonic #17	Float [32b-LSW]	R		41923
I_N_H_18	Line Current N Harmonic #18	Float [32b-LSW]	R		41925
I_N_H_19	Line Current N Harmonic #19	Float [32b-LSW]	R		41927
I_N_H_20	Line Current N Harmonic #20	Float [32b-LSW]	R		41929
I_N_H_21	Line Current N Harmonic #21	Float [32b-LSW]	R		41931
I_N_H_22	Line Current N Harmonic #22	Float [32b-LSW]	R		41933
I_N_H_23	Line Current N Harmonic #23	Float [32b-LSW]	R		41935
I_N_H_24	Line Current N Harmonic #24	Float [32b-LSW]	R		41937
I_N_H_25	Line Current N Harmonic #25	Float [32b-LSW]	R		41939
I_N_H_26	Line Current N Harmonic #26	Float [32b-LSW]	R		41941
I_N_H_27	Line Current N Harmonic #27	Float [32b-LSW]	R		41943
I_N_H_28	Line Current N Harmonic #28	Float [32b-LSW]	R		41945
I_N_H_29	Line Current N Harmonic #29	Float [32b-LSW]	R		41947
I_N_H_30	Line Current N Harmonic #30	Float [32b-LSW]	R		41949
I_N_H_31	Line Current N Harmonic #31	Float [32b-LSW]	R		41951
I_N_H_32	Line Current N Harmonic #32	Float [32b-LSW]	R		41953
I_N_H_33	Line Current N Harmonic #33	Float [32b-LSW]	R		41955
I_N_H_34	Line Current N Harmonic #34	Float [32b-LSW]	R		41957
I_N_H_35	Line Current N Harmonic #35	Float [32b-LSW]	R		41959
I_N_H_36	Line Current N Harmonic #36	Float [32b-LSW]	R		41961
I_N_H_37	Line Current N Harmonic #37	Float [32b-LSW]	R		41963
I_N_H_38	Line Current N Harmonic #38	Float [32b-LSW]	R		41965
I_N_H_39	Line Current N Harmonic #39	Float [32b-LSW]	R		41967
I_N_H_40	Line Current N Harmonic #40	Float [32b-LSW]	R		41969
I_N_H_41	Line Current N Harmonic #41	Float [32b-LSW]	R		41971
I_N_H_42	Line Current N Harmonic #42	Float [32b-LSW]	R		41973
I_N_H_43	Line Current N Harmonic #43	Float [32b-LSW]	R		41975
I_N_H_44	Line Current N Harmonic #44	Float [32b-LSW]	R		41977
I_N_H_45	Line Current N Harmonic #45	Float [32b-LSW]	R		41979
I_N_H_46	Line Current N Harmonic #46	Float [32b-LSW]	R		41981
I_N_H_47	Line Current N Harmonic #47	Float [32b-LSW]	R		41983
I_N_H_48	Line Current N Harmonic #48	Float [32b-LSW]	R		41985
I_N_H_49	Line Current N Harmonic #49	Float [32b-LSW]	R		41987
I_N_H_50	Line Current N Harmonic #50	Float [32b-LSW]	R		41989
I_N_H_51	Line Current N Harmonic #51	Float [32b-LSW]	R		41991
I_N_H_52	Line Current N Harmonic #52	Float [32b-LSW]	R		41993
I_N_H_53	Line Current N Harmonic #53	Float [32b-LSW]	R		41995
I_N_H_54	Line Current N Harmonic #54	Float [32b-LSW]	R		41997
I_N_H_55	Line Current N Harmonic #55	Float [32b-LSW]	R		41999
I_N_H_56	Line Current N Harmonic #56	Float [32b-LSW]	R		42001
I_N_H_57	Line Current N Harmonic #57	Float [32b-LSW]	R		42003
I_N_H_58	Line Current N Harmonic #58	Float [32b-LSW]	R		42005
I_N_H_59	Line Current N Harmonic #59	Float [32b-LSW]	R		42007
I_N_H_60	Line Current N Harmonic #60	Float [32b-LSW]	R		42009
I_N_H_61	Line Current N Harmonic #61	Float [32b-LSW]	R		42011
I_N_H_62	Line Current N Harmonic #62	Float [32b-LSW]	R		42013
I_N_H_63	Line Current N Harmonic #63	Float [32b-LSW]	R		42015
V_L1N_IH_0	Star Voltage L1-N InterHarmonic #0	Float [32b-LSW]	R		42017
V_L1N_IH_1	Star Voltage L1-N InterHarmonic #1	Float [32b-LSW]	R		42019
V_L1N_IH_2	Star Voltage L1-N InterHarmonic #2	Float [32b-LSW]	R		42021
V_L1N_IH_3	Star Voltage L1-N InterHarmonic #3	Float [32b-LSW]	R		42023
V_L1N_IH_4	Star Voltage L1-N InterHarmonic #4	Float [32b-LSW]	R		42025
V_L1N_IH_5	Star Voltage L1-N InterHarmonic #5	Float [32b-LSW]	R		42027
V_L1N_IH_6	Star Voltage L1-N InterHarmonic #6	Float [32b-LSW]	R		42029
V_L1N_IH_7	Star Voltage L1-N InterHarmonic #7	Float [32b-LSW]	R		42031
V_L1N_IH_8	Star Voltage L1-N InterHarmonic #8	Float [32b-LSW]	R		42033
V_L1N_IH_9	Star Voltage L1-N InterHarmonic #9	Float [32b-LSW]	R		42035
V_L1N_IH_10	Star Voltage L1-N InterHarmonic #10	Float [32b-LSW]	R		42037
V_L1N_IH_11	Star Voltage L1-N InterHarmonic #11	Float [32b-LSW]	R		42039
V_L1N_IH_12	Star Voltage L1-N InterHarmonic #12	Float [32b-LSW]	R		42041
V_L1N_IH_13	Star Voltage L1-N InterHarmonic #13	Float [32b-LSW]	R		42043
V_L1N_IH_14	Star Voltage L1-N InterHarmonic #14	Float [32b-LSW]	R		42045



Register Name	Description	Register Type	R/W	Default	Address Modbus
V_L1N_IH_15	Star Voltage L1-N InterHarmonic #15	Float [32b-LSW]	R		42047
V_L1N_IH_16	Star Voltage L1-N InterHarmonic #16	Float [32b-LSW]	R		42049
V_L1N_IH_17	Star Voltage L1-N InterHarmonic #17	Float [32b-LSW]	R		42051
V_L1N_IH_18	Star Voltage L1-N InterHarmonic #18	Float [32b-LSW]	R		42053
V_L1N_IH_19	Star Voltage L1-N InterHarmonic #19	Float [32b-LSW]	R		42055
V_L1N_IH_20	Star Voltage L1-N InterHarmonic #20	Float [32b-LSW]	R		42057
V_L1N_IH_21	Star Voltage L1-N InterHarmonic #21	Float [32b-LSW]	R		42059
V_L1N_IH_22	Star Voltage L1-N InterHarmonic #22	Float [32b-LSW]	R		42061
V_L1N_IH_23	Star Voltage L1-N InterHarmonic #23	Float [32b-LSW]	R		42063
V_L1N_IH_24	Star Voltage L1-N InterHarmonic #24	Float [32b-LSW]	R		42065
V_L1N_IH_25	Star Voltage L1-N InterHarmonic #25	Float [32b-LSW]	R		42067
V_L1N_IH_26	Star Voltage L1-N InterHarmonic #26	Float [32b-LSW]	R		42069
V_L1N_IH_27	Star Voltage L1-N InterHarmonic #27	Float [32b-LSW]	R		42071
V_L1N_IH_28	Star Voltage L1-N InterHarmonic #28	Float [32b-LSW]	R		42073
V_L1N_IH_29	Star Voltage L1-N InterHarmonic #29	Float [32b-LSW]	R		42075
V_L1N_IH_30	Star Voltage L1-N InterHarmonic #30	Float [32b-LSW]	R		42077
V_L1N_IH_31	Star Voltage L1-N InterHarmonic #31	Float [32b-LSW]	R		42079
V_L1N_IH_32	Star Voltage L1-N InterHarmonic #32	Float [32b-LSW]	R		42081
V_L1N_IH_33	Star Voltage L1-N InterHarmonic #33	Float [32b-LSW]	R		42083
V_L1N_IH_34	Star Voltage L1-N InterHarmonic #34	Float [32b-LSW]	R		42085
V_L1N_IH_35	Star Voltage L1-N InterHarmonic #35	Float [32b-LSW]	R		42087
V_L1N_IH_36	Star Voltage L1-N InterHarmonic #36	Float [32b-LSW]	R		42089
V_L1N_IH_37	Star Voltage L1-N InterHarmonic #37	Float [32b-LSW]	R		42091
V_L1N_IH_38	Star Voltage L1-N InterHarmonic #38	Float [32b-LSW]	R		42093
V_L1N_IH_39	Star Voltage L1-N InterHarmonic #39	Float [32b-LSW]	R		42095
V_L1N_IH_40	Star Voltage L1-N InterHarmonic #40	Float [32b-LSW]	R		42097
V_L1N_IH_41	Star Voltage L1-N InterHarmonic #41	Float [32b-LSW]	R		42099
V_L1N_IH_42	Star Voltage L1-N InterHarmonic #42	Float [32b-LSW]	R		42101
V_L1N_IH_43	Star Voltage L1-N InterHarmonic #43	Float [32b-LSW]	R		42103
V_L1N_IH_44	Star Voltage L1-N InterHarmonic #44	Float [32b-LSW]	R		42105
V_L1N_IH_45	Star Voltage L1-N InterHarmonic #45	Float [32b-LSW]	R		42107
V_L1N_IH_46	Star Voltage L1-N InterHarmonic #46	Float [32b-LSW]	R		42109
V_L1N_IH_47	Star Voltage L1-N InterHarmonic #47	Float [32b-LSW]	R		42111
V_L1N_IH_48	Star Voltage L1-N InterHarmonic #48	Float [32b-LSW]	R		42113
V_L1N_IH_49	Star Voltage L1-N InterHarmonic #49	Float [32b-LSW]	R		42115
V_L1N_IH_50	Star Voltage L1-N InterHarmonic #50	Float [32b-LSW]	R		42117
V_L1N_IH_51	Star Voltage L1-N InterHarmonic #51	Float [32b-LSW]	R		42119
V_L1N_IH_52	Star Voltage L1-N InterHarmonic #52	Float [32b-LSW]	R		42121
V_L1N_IH_53	Star Voltage L1-N InterHarmonic #53	Float [32b-LSW]	R		42123
V_L1N_IH_54	Star Voltage L1-N InterHarmonic #54	Float [32b-LSW]	R		42125
V_L1N_IH_55	Star Voltage L1-N InterHarmonic #55	Float [32b-LSW]	R		42127
V_L1N_IH_56	Star Voltage L1-N InterHarmonic #56	Float [32b-LSW]	R		42129
V_L1N_IH_57	Star Voltage L1-N InterHarmonic #57	Float [32b-LSW]	R		42131
V_L1N_IH_58	Star Voltage L1-N InterHarmonic #58	Float [32b-LSW]	R		42133
V_L1N_IH_59	Star Voltage L1-N InterHarmonic #59	Float [32b-LSW]	R		42135
V_L1N_IH_60	Star Voltage L1-N InterHarmonic #60	Float [32b-LSW]	R		42137
V_L1N_IH_61	Star Voltage L1-N InterHarmonic #61	Float [32b-LSW]	R		42139
V_L1N_IH_62	Star Voltage L1-N InterHarmonic #62	Float [32b-LSW]	R		42141
V_L1N_IH_63	Star Voltage L1-N InterHarmonic #63	Float [32b-LSW]	R		42143
V_L2N_IH_0	Star Voltage L2-N InterHarmonic #0	Float [32b-LSW]	R		42145
V_L2N_IH_1	Star Voltage L2-N InterHarmonic #1	Float [32b-LSW]	R		42147
V_L2N_IH_2	Star Voltage L2-N InterHarmonic #2	Float [32b-LSW]	R		42149
V_L2N_IH_3	Star Voltage L2-N InterHarmonic #3	Float [32b-LSW]	R		42151
V_L2N_IH_4	Star Voltage L2-N InterHarmonic #4	Float [32b-LSW]	R		42153
V_L2N_IH_5	Star Voltage L2-N InterHarmonic #5	Float [32b-LSW]	R		42155
V_L2N_IH_6	Star Voltage L2-N InterHarmonic #6	Float [32b-LSW]	R		42157
V_L2N_IH_7	Star Voltage L2-N InterHarmonic #7	Float [32b-LSW]	R		42159
V_L2N_IH_8	Star Voltage L2-N InterHarmonic #8	Float [32b-LSW]	R		42161
V_L2N_IH_9	Star Voltage L2-N InterHarmonic #9	Float [32b-LSW]	R		42163
V_L2N_IH_10	Star Voltage L2-N InterHarmonic #10	Float [32b-LSW]	R		42165
V_L2N_IH_11	Star Voltage L2-N InterHarmonic #11	Float [32b-LSW]	R		42167
V_L2N_IH_12	Star Voltage L2-N InterHarmonic #12	Float [32b-LSW]	R		42169
V_L2N_IH_13	Star Voltage L2-N InterHarmonic #13	Float [32b-LSW]	R		42171



Register Name	Description	Register Type	R/W	Default	Address Modbus
V_L2N_IH_14	Star Voltage L2-N InterHarmonic #14	Float [32b-LSW]	R		42173
V_L2N_IH_15	Star Voltage L2-N InterHarmonic #15	Float [32b-LSW]	R		42175
V_L2N_IH_16	Star Voltage L2-N InterHarmonic #16	Float [32b-LSW]	R		42177
V_L2N_IH_17	Star Voltage L2-N InterHarmonic #17	Float [32b-LSW]	R		42179
V_L2N_IH_18	Star Voltage L2-N InterHarmonic #18	Float [32b-LSW]	R		42181
V_L2N_IH_19	Star Voltage L2-N InterHarmonic #19	Float [32b-LSW]	R		42183
V_L2N_IH_20	Star Voltage L2-N InterHarmonic #20	Float [32b-LSW]	R		42185
V_L2N_IH_21	Star Voltage L2-N InterHarmonic #21	Float [32b-LSW]	R		42187
V_L2N_IH_22	Star Voltage L2-N InterHarmonic #22	Float [32b-LSW]	R		42189
V_L2N_IH_23	Star Voltage L2-N InterHarmonic #23	Float [32b-LSW]	R		42191
V_L2N_IH_24	Star Voltage L2-N InterHarmonic #24	Float [32b-LSW]	R		42193
V_L2N_IH_25	Star Voltage L2-N InterHarmonic #25	Float [32b-LSW]	R		42195
V_L2N_IH_26	Star Voltage L2-N InterHarmonic #26	Float [32b-LSW]	R		42197
V_L2N_IH_27	Star Voltage L2-N InterHarmonic #27	Float [32b-LSW]	R		42199
V_L2N_IH_28	Star Voltage L2-N InterHarmonic #28	Float [32b-LSW]	R		42201
V_L2N_IH_29	Star Voltage L2-N InterHarmonic #29	Float [32b-LSW]	R		42203
V_L2N_IH_30	Star Voltage L2-N InterHarmonic #30	Float [32b-LSW]	R		42205
V_L2N_IH_31	Star Voltage L2-N InterHarmonic #31	Float [32b-LSW]	R		42207
V_L2N_IH_32	Star Voltage L2-N InterHarmonic #32	Float [32b-LSW]	R		42209
V_L2N_IH_33	Star Voltage L2-N InterHarmonic #33	Float [32b-LSW]	R		42211
V_L2N_IH_34	Star Voltage L2-N InterHarmonic #34	Float [32b-LSW]	R		42213
V_L2N_IH_35	Star Voltage L2-N InterHarmonic #35	Float [32b-LSW]	R		42215
V_L2N_IH_36	Star Voltage L2-N InterHarmonic #36	Float [32b-LSW]	R		42217
V_L2N_IH_37	Star Voltage L2-N InterHarmonic #37	Float [32b-LSW]	R		42219
V_L2N_IH_38	Star Voltage L2-N InterHarmonic #38	Float [32b-LSW]	R		42221
V_L2N_IH_39	Star Voltage L2-N InterHarmonic #39	Float [32b-LSW]	R		42223
V_L2N_IH_40	Star Voltage L2-N InterHarmonic #40	Float [32b-LSW]	R		42225
V_L2N_IH_41	Star Voltage L2-N InterHarmonic #41	Float [32b-LSW]	R		42227
V_L2N_IH_42	Star Voltage L2-N InterHarmonic #42	Float [32b-LSW]	R		42229
V_L2N_IH_43	Star Voltage L2-N InterHarmonic #43	Float [32b-LSW]	R		42231
V_L2N_IH_44	Star Voltage L2-N InterHarmonic #44	Float [32b-LSW]	R		42233
V_L2N_IH_45	Star Voltage L2-N InterHarmonic #45	Float [32b-LSW]	R		42235
V_L2N_IH_46	Star Voltage L2-N InterHarmonic #46	Float [32b-LSW]	R		42237
V_L2N_IH_47	Star Voltage L2-N InterHarmonic #47	Float [32b-LSW]	R		42239
V_L2N_IH_48	Star Voltage L2-N InterHarmonic #48	Float [32b-LSW]	R		42241
V_L2N_IH_49	Star Voltage L2-N InterHarmonic #49	Float [32b-LSW]	R		42243
V_L2N_IH_50	Star Voltage L2-N InterHarmonic #50	Float [32b-LSW]	R		42245
V_L2N_IH_51	Star Voltage L2-N InterHarmonic #51	Float [32b-LSW]	R		42247
V_L2N_IH_52	Star Voltage L2-N InterHarmonic #52	Float [32b-LSW]	R		42249
V_L2N_IH_53	Star Voltage L2-N InterHarmonic #53	Float [32b-LSW]	R		42251
V_L2N_IH_54	Star Voltage L2-N InterHarmonic #54	Float [32b-LSW]	R		42253
V_L2N_IH_55	Star Voltage L2-N InterHarmonic #55	Float [32b-LSW]	R		42255
V_L2N_IH_56	Star Voltage L2-N InterHarmonic #56	Float [32b-LSW]	R		42257
V_L2N_IH_57	Star Voltage L2-N InterHarmonic #57	Float [32b-LSW]	R		42259
V_L2N_IH_58	Star Voltage L2-N InterHarmonic #58	Float [32b-LSW]	R		42261
V_L2N_IH_59	Star Voltage L2-N InterHarmonic #59	Float [32b-LSW]	R		42263
V_L2N_IH_60	Star Voltage L2-N InterHarmonic #60	Float [32b-LSW]	R		42265
V_L2N_IH_61	Star Voltage L2-N InterHarmonic #61	Float [32b-LSW]	R		42267
V_L2N_IH_62	Star Voltage L2-N InterHarmonic #62	Float [32b-LSW]	R		42269
V_L2N_IH_63	Star Voltage L2-N InterHarmonic #63	Float [32b-LSW]	R		42271
V_L3N_IH_0	Star Voltage L3-N InterHarmonic #0	Float [32b-LSW]	R		42273
V_L3N_IH_1	Star Voltage L3-N InterHarmonic #1	Float [32b-LSW]	R		42275
V_L3N_IH_2	Star Voltage L3-N InterHarmonic #2	Float [32b-LSW]	R		42277
V_L3N_IH_3	Star Voltage L3-N InterHarmonic #3	Float [32b-LSW]	R		42279
V_L3N_IH_4	Star Voltage L3-N InterHarmonic #4	Float [32b-LSW]	R		42281
V_L3N_IH_5	Star Voltage L3-N InterHarmonic #5	Float [32b-LSW]	R		42283
V_L3N_IH_6	Star Voltage L3-N InterHarmonic #6	Float [32b-LSW]	R		42285
V_L3N_IH_7	Star Voltage L3-N InterHarmonic #7	Float [32b-LSW]	R		42287
V_L3N_IH_8	Star Voltage L3-N InterHarmonic #8	Float [32b-LSW]	R		42289
V_L3N_IH_9	Star Voltage L3-N InterHarmonic #9	Float [32b-LSW]	R		42291
V_L3N_IH_10	Star Voltage L3-N InterHarmonic #10	Float [32b-LSW]	R		42293
V_L3N_IH_11	Star Voltage L3-N InterHarmonic #11	Float [32b-LSW]	R		42295
V_L3N_IH_12	Star Voltage L3-N InterHarmonic #12	Float [32b-LSW]	R		42297



Register Name	Description	Register Type	R/W	Default	Address Modbus
V_L3N_IH_13	Star Voltage L3-N InterHarmonic #13	Float [32b-LSW]	R		42299
V_L3N_IH_14	Star Voltage L3-N InterHarmonic #14	Float [32b-LSW]	R		42301
V_L3N_IH_15	Star Voltage L3-N InterHarmonic #15	Float [32b-LSW]	R		42303
V_L3N_IH_16	Star Voltage L3-N InterHarmonic #16	Float [32b-LSW]	R		42305
V_L3N_IH_17	Star Voltage L3-N InterHarmonic #17	Float [32b-LSW]	R		42307
V_L3N_IH_18	Star Voltage L3-N InterHarmonic #18	Float [32b-LSW]	R		42309
V_L3N_IH_19	Star Voltage L3-N InterHarmonic #19	Float [32b-LSW]	R		42311
V_L3N_IH_20	Star Voltage L3-N InterHarmonic #20	Float [32b-LSW]	R		42313
V_L3N_IH_21	Star Voltage L3-N InterHarmonic #21	Float [32b-LSW]	R		42315
V_L3N_IH_22	Star Voltage L3-N InterHarmonic #22	Float [32b-LSW]	R		42317
V_L3N_IH_23	Star Voltage L3-N InterHarmonic #23	Float [32b-LSW]	R		42319
V_L3N_IH_24	Star Voltage L3-N InterHarmonic #24	Float [32b-LSW]	R		42321
V_L3N_IH_25	Star Voltage L3-N InterHarmonic #25	Float [32b-LSW]	R		42323
V_L3N_IH_26	Star Voltage L3-N InterHarmonic #26	Float [32b-LSW]	R		42325
V_L3N_IH_27	Star Voltage L3-N InterHarmonic #27	Float [32b-LSW]	R		42327
V_L3N_IH_28	Star Voltage L3-N InterHarmonic #28	Float [32b-LSW]	R		42329
V_L3N_IH_29	Star Voltage L3-N InterHarmonic #29	Float [32b-LSW]	R		42331
V_L3N_IH_30	Star Voltage L3-N InterHarmonic #30	Float [32b-LSW]	R		42333
V_L3N_IH_31	Star Voltage L3-N InterHarmonic #31	Float [32b-LSW]	R		42335
V_L3N_IH_32	Star Voltage L3-N InterHarmonic #32	Float [32b-LSW]	R		42337
V_L3N_IH_33	Star Voltage L3-N InterHarmonic #33	Float [32b-LSW]	R		42339
V_L3N_IH_34	Star Voltage L3-N InterHarmonic #34	Float [32b-LSW]	R		42341
V_L3N_IH_35	Star Voltage L3-N InterHarmonic #35	Float [32b-LSW]	R		42343
V_L3N_IH_36	Star Voltage L3-N InterHarmonic #36	Float [32b-LSW]	R		42345
V_L3N_IH_37	Star Voltage L3-N InterHarmonic #37	Float [32b-LSW]	R		42347
V_L3N_IH_38	Star Voltage L3-N InterHarmonic #38	Float [32b-LSW]	R		42349
V_L3N_IH_39	Star Voltage L3-N InterHarmonic #39	Float [32b-LSW]	R		42351
V_L3N_IH_40	Star Voltage L3-N InterHarmonic #40	Float [32b-LSW]	R		42353
V_L3N_IH_41	Star Voltage L3-N InterHarmonic #41	Float [32b-LSW]	R		42355
V_L3N_IH_42	Star Voltage L3-N InterHarmonic #42	Float [32b-LSW]	R		42357
V_L3N_IH_43	Star Voltage L3-N InterHarmonic #43	Float [32b-LSW]	R		42359
V_L3N_IH_44	Star Voltage L3-N InterHarmonic #44	Float [32b-LSW]	R		42361
V_L3N_IH_45	Star Voltage L3-N InterHarmonic #45	Float [32b-LSW]	R		42363
V_L3N_IH_46	Star Voltage L3-N InterHarmonic #46	Float [32b-LSW]	R		42365
V_L3N_IH_47	Star Voltage L3-N InterHarmonic #47	Float [32b-LSW]	R		42367
V_L3N_IH_48	Star Voltage L3-N InterHarmonic #48	Float [32b-LSW]	R		42369
V_L3N_IH_49	Star Voltage L3-N InterHarmonic #49	Float [32b-LSW]	R		42371
V_L3N_IH_50	Star Voltage L3-N InterHarmonic #50	Float [32b-LSW]	R		42373
V_L3N_IH_51	Star Voltage L3-N InterHarmonic #51	Float [32b-LSW]	R		42375
V_L3N_IH_52	Star Voltage L3-N InterHarmonic #52	Float [32b-LSW]	R		42377
V_L3N_IH_53	Star Voltage L3-N InterHarmonic #53	Float [32b-LSW]	R		42379
V_L3N_IH_54	Star Voltage L3-N InterHarmonic #54	Float [32b-LSW]	R		42381
V_L3N_IH_55	Star Voltage L3-N InterHarmonic #55	Float [32b-LSW]	R		42383
V_L3N_IH_56	Star Voltage L3-N InterHarmonic #56	Float [32b-LSW]	R		42385
V_L3N_IH_57	Star Voltage L3-N InterHarmonic #57	Float [32b-LSW]	R		42387
V_L3N_IH_58	Star Voltage L3-N InterHarmonic #58	Float [32b-LSW]	R		42389
V_L3N_IH_59	Star Voltage L3-N InterHarmonic #59	Float [32b-LSW]	R		42391
V_L3N_IH_60	Star Voltage L3-N InterHarmonic #60	Float [32b-LSW]	R		42393
V_L3N_IH_61	Star Voltage L3-N InterHarmonic #61	Float [32b-LSW]	R		42395
V_L3N_IH_62	Star Voltage L3-N InterHarmonic #62	Float [32b-LSW]	R		42397
V_L3N_IH_63	Star Voltage L3-N InterHarmonic #63	Float [32b-LSW]	R		42399
V_L12_IH_0	Line Voltage L1-L2 InterHarmonic #0	Float [32b-LSW]	R		42401
V_L12_IH_1	Line Voltage L1-L2 InterHarmonic #1	Float [32b-LSW]	R		42403
V_L12_IH_2	Line Voltage L1-L2 InterHarmonic #2	Float [32b-LSW]	R		42405
V_L12_IH_3	Line Voltage L1-L2 InterHarmonic #3	Float [32b-LSW]	R		42407
V_L12_IH_4	Line Voltage L1-L2 InterHarmonic #4	Float [32b-LSW]	R		42409
V_L12_IH_5	Line Voltage L1-L2 InterHarmonic #5	Float [32b-LSW]	R		42411
V_L12_IH_6	Line Voltage L1-L2 InterHarmonic #6	Float [32b-LSW]	R		42413
V_L12_IH_7	Line Voltage L1-L2 InterHarmonic #7	Float [32b-LSW]	R		42415
V_L12_IH_8	Line Voltage L1-L2 InterHarmonic #8	Float [32b-LSW]	R		42417
V_L12_IH_9	Line Voltage L1-L2 InterHarmonic #9	Float [32b-LSW]	R		42419
V_L12_IH_10	Line Voltage L1-L2 InterHarmonic #10	Float [32b-LSW]	R		42421
V_L12_IH_11	Line Voltage L1-L2 InterHarmonic #11	Float [32b-LSW]	R		42423



Register Name	Description	Register Type	R/W	Default	Address Modbus
V_L12_IH_12	Line Voltage L1-L2 InterHarmonic #12	Float [32b-LSW]	R		42425
V_L12_IH_13	Line Voltage L1-L2 InterHarmonic #13	Float [32b-LSW]	R		42427
V_L12_IH_14	Line Voltage L1-L2 InterHarmonic #14	Float [32b-LSW]	R		42429
V_L12_IH_15	Line Voltage L1-L2 InterHarmonic #15	Float [32b-LSW]	R		42431
V_L12_IH_16	Line Voltage L1-L2 InterHarmonic #16	Float [32b-LSW]	R		42433
V_L12_IH_17	Line Voltage L1-L2 InterHarmonic #17	Float [32b-LSW]	R		42435
V_L12_IH_18	Line Voltage L1-L2 InterHarmonic #18	Float [32b-LSW]	R		42437
V_L12_IH_19	Line Voltage L1-L2 InterHarmonic #19	Float [32b-LSW]	R		42439
V_L12_IH_20	Line Voltage L1-L2 InterHarmonic #20	Float [32b-LSW]	R		42441
V_L12_IH_21	Line Voltage L1-L2 InterHarmonic #21	Float [32b-LSW]	R		42443
V_L12_IH_22	Line Voltage L1-L2 InterHarmonic #22	Float [32b-LSW]	R		42445
V_L12_IH_23	Line Voltage L1-L2 InterHarmonic #23	Float [32b-LSW]	R		42447
V_L12_IH_24	Line Voltage L1-L2 InterHarmonic #24	Float [32b-LSW]	R		42449
V_L12_IH_25	Line Voltage L1-L2 InterHarmonic #25	Float [32b-LSW]	R		42451
V_L12_IH_26	Line Voltage L1-L2 InterHarmonic #26	Float [32b-LSW]	R		42453
V_L12_IH_27	Line Voltage L1-L2 InterHarmonic #27	Float [32b-LSW]	R		42455
V_L12_IH_28	Line Voltage L1-L2 InterHarmonic #28	Float [32b-LSW]	R		42457
V_L12_IH_29	Line Voltage L1-L2 InterHarmonic #29	Float [32b-LSW]	R		42459
V_L12_IH_30	Line Voltage L1-L2 InterHarmonic #30	Float [32b-LSW]	R		42461
V_L12_IH_31	Line Voltage L1-L2 InterHarmonic #31	Float [32b-LSW]	R		42463
V_L12_IH_32	Line Voltage L1-L2 InterHarmonic #32	Float [32b-LSW]	R		42465
V_L12_IH_33	Line Voltage L1-L2 InterHarmonic #33	Float [32b-LSW]	R		42467
V_L12_IH_34	Line Voltage L1-L2 InterHarmonic #34	Float [32b-LSW]	R		42469
V_L12_IH_35	Line Voltage L1-L2 InterHarmonic #35	Float [32b-LSW]	R		42471
V_L12_IH_36	Line Voltage L1-L2 InterHarmonic #36	Float [32b-LSW]	R		42473
V_L12_IH_37	Line Voltage L1-L2 InterHarmonic #37	Float [32b-LSW]	R		42475
V_L12_IH_38	Line Voltage L1-L2 InterHarmonic #38	Float [32b-LSW]	R		42477
V_L12_IH_39	Line Voltage L1-L2 InterHarmonic #39	Float [32b-LSW]	R		42479
V_L12_IH_40	Line Voltage L1-L2 InterHarmonic #40	Float [32b-LSW]	R		42481
V_L12_IH_41	Line Voltage L1-L2 InterHarmonic #41	Float [32b-LSW]	R		42483
V_L12_IH_42	Line Voltage L1-L2 InterHarmonic #42	Float [32b-LSW]	R		42485
V_L12_IH_43	Line Voltage L1-L2 InterHarmonic #43	Float [32b-LSW]	R		42487
V_L12_IH_44	Line Voltage L1-L2 InterHarmonic #44	Float [32b-LSW]	R		42489
V_L12_IH_45	Line Voltage L1-L2 InterHarmonic #45	Float [32b-LSW]	R		42491
V_L12_IH_46	Line Voltage L1-L2 InterHarmonic #46	Float [32b-LSW]	R		42493
V_L12_IH_47	Line Voltage L1-L2 InterHarmonic #47	Float [32b-LSW]	R		42495
V_L12_IH_48	Line Voltage L1-L2 InterHarmonic #48	Float [32b-LSW]	R		42497
V_L12_IH_49	Line Voltage L1-L2 InterHarmonic #49	Float [32b-LSW]	R		42499
V_L12_IH_50	Line Voltage L1-L2 InterHarmonic #50	Float [32b-LSW]	R		42501
V_L12_IH_51	Line Voltage L1-L2 InterHarmonic #51	Float [32b-LSW]	R		42503
V_L12_IH_52	Line Voltage L1-L2 InterHarmonic #52	Float [32b-LSW]	R		42505
V_L12_IH_53	Line Voltage L1-L2 InterHarmonic #53	Float [32b-LSW]	R		42507
V_L12_IH_54	Line Voltage L1-L2 InterHarmonic #54	Float [32b-LSW]	R		42509
V_L12_IH_55	Line Voltage L1-L2 InterHarmonic #55	Float [32b-LSW]	R		42511
V_L12_IH_56	Line Voltage L1-L2 InterHarmonic #56	Float [32b-LSW]	R		42513
V_L12_IH_57	Line Voltage L1-L2 InterHarmonic #57	Float [32b-LSW]	R		42515
V_L12_IH_58	Line Voltage L1-L2 InterHarmonic #58	Float [32b-LSW]	R		42517
V_L12_IH_59	Line Voltage L1-L2 InterHarmonic #59	Float [32b-LSW]	R		42519
V_L12_IH_60	Line Voltage L1-L2 InterHarmonic #60	Float [32b-LSW]	R		42521
V_L12_IH_61	Line Voltage L1-L2 InterHarmonic #61	Float [32b-LSW]	R		42523
V_L12_IH_62	Line Voltage L1-L2 InterHarmonic #62	Float [32b-LSW]	R		42525
V_L12_IH_63	Line Voltage L1-L2 InterHarmonic #63	Float [32b-LSW]	R		42527
V_L23_IH_0	Line Voltage L2-L3 InterHarmonic #0	Float [32b-LSW]	R		42529
V_L23_IH_1	Line Voltage L2-L3 InterHarmonic #1	Float [32b-LSW]	R		42531
V_L23_IH_2	Line Voltage L2-L3 InterHarmonic #2	Float [32b-LSW]	R		42533
V_L23_IH_3	Line Voltage L2-L3 InterHarmonic #3	Float [32b-LSW]	R		42535
V_L23_IH_4	Line Voltage L2-L3 InterHarmonic #4	Float [32b-LSW]	R		42537
V_L23_IH_5	Line Voltage L2-L3 InterHarmonic #5	Float [32b-LSW]	R		42539
V_L23_IH_6	Line Voltage L2-L3 InterHarmonic #6	Float [32b-LSW]	R		42541
V_L23_IH_7	Line Voltage L2-L3 InterHarmonic #7	Float [32b-LSW]	R		42543
V_L23_IH_8	Line Voltage L2-L3 InterHarmonic #8	Float [32b-LSW]	R		42545
V_L23_IH_9	Line Voltage L2-L3 InterHarmonic #9	Float [32b-LSW]	R		42547
V_L23_IH_10	Line Voltage L2-L3 InterHarmonic #10	Float [32b-LSW]	R		42549



Register Name	Description	Register Type	R/W	Default	Address Modbus
V_L23_IH_11	Line Voltage L2-L3 InterHarmonic #11	Float [32b-LSW]	R		42551
V_L23_IH_12	Line Voltage L2-L3 InterHarmonic #12	Float [32b-LSW]	R		42553
V_L23_IH_13	Line Voltage L2-L3 InterHarmonic #13	Float [32b-LSW]	R		42555
V_L23_IH_14	Line Voltage L2-L3 InterHarmonic #14	Float [32b-LSW]	R		42557
V_L23_IH_15	Line Voltage L2-L3 InterHarmonic #15	Float [32b-LSW]	R		42559
V_L23_IH_16	Line Voltage L2-L3 InterHarmonic #16	Float [32b-LSW]	R		42561
V_L23_IH_17	Line Voltage L2-L3 InterHarmonic #17	Float [32b-LSW]	R		42563
V_L23_IH_18	Line Voltage L2-L3 InterHarmonic #18	Float [32b-LSW]	R		42565
V_L23_IH_19	Line Voltage L2-L3 InterHarmonic #19	Float [32b-LSW]	R		42567
V_L23_IH_20	Line Voltage L2-L3 InterHarmonic #20	Float [32b-LSW]	R		42569
V_L23_IH_21	Line Voltage L2-L3 InterHarmonic #21	Float [32b-LSW]	R		42571
V_L23_IH_22	Line Voltage L2-L3 InterHarmonic #22	Float [32b-LSW]	R		42573
V_L23_IH_23	Line Voltage L2-L3 InterHarmonic #23	Float [32b-LSW]	R		42575
V_L23_IH_24	Line Voltage L2-L3 InterHarmonic #24	Float [32b-LSW]	R		42577
V_L23_IH_25	Line Voltage L2-L3 InterHarmonic #25	Float [32b-LSW]	R		42579
V_L23_IH_26	Line Voltage L2-L3 InterHarmonic #26	Float [32b-LSW]	R		42581
V_L23_IH_27	Line Voltage L2-L3 InterHarmonic #27	Float [32b-LSW]	R		42583
V_L23_IH_28	Line Voltage L2-L3 InterHarmonic #28	Float [32b-LSW]	R		42585
V_L23_IH_29	Line Voltage L2-L3 InterHarmonic #29	Float [32b-LSW]	R		42587
V_L23_IH_30	Line Voltage L2-L3 InterHarmonic #30	Float [32b-LSW]	R		42589
V_L23_IH_31	Line Voltage L2-L3 InterHarmonic #31	Float [32b-LSW]	R		42591
V_L23_IH_32	Line Voltage L2-L3 InterHarmonic #32	Float [32b-LSW]	R		42593
V_L23_IH_33	Line Voltage L2-L3 InterHarmonic #33	Float [32b-LSW]	R		42595
V_L23_IH_34	Line Voltage L2-L3 InterHarmonic #34	Float [32b-LSW]	R		42597
V_L23_IH_35	Line Voltage L2-L3 InterHarmonic #35	Float [32b-LSW]	R		42599
V_L23_IH_36	Line Voltage L2-L3 InterHarmonic #36	Float [32b-LSW]	R		42601
V_L23_IH_37	Line Voltage L2-L3 InterHarmonic #37	Float [32b-LSW]	R		42603
V_L23_IH_38	Line Voltage L2-L3 InterHarmonic #38	Float [32b-LSW]	R		42605
V_L23_IH_39	Line Voltage L2-L3 InterHarmonic #39	Float [32b-LSW]	R		42607
V_L23_IH_40	Line Voltage L2-L3 InterHarmonic #40	Float [32b-LSW]	R		42609
V_L23_IH_41	Line Voltage L2-L3 InterHarmonic #41	Float [32b-LSW]	R		42611
V_L23_IH_42	Line Voltage L2-L3 InterHarmonic #42	Float [32b-LSW]	R		42613
V_L23_IH_43	Line Voltage L2-L3 InterHarmonic #43	Float [32b-LSW]	R		42615
V_L23_IH_44	Line Voltage L2-L3 InterHarmonic #44	Float [32b-LSW]	R		42617
V_L23_IH_45	Line Voltage L2-L3 InterHarmonic #45	Float [32b-LSW]	R		42619
V_L23_IH_46	Line Voltage L2-L3 InterHarmonic #46	Float [32b-LSW]	R		42621
V_L23_IH_47	Line Voltage L2-L3 InterHarmonic #47	Float [32b-LSW]	R		42623
V_L23_IH_48	Line Voltage L2-L3 InterHarmonic #48	Float [32b-LSW]	R		42625
V_L23_IH_49	Line Voltage L2-L3 InterHarmonic #49	Float [32b-LSW]	R		42627
V_L23_IH_50	Line Voltage L2-L3 InterHarmonic #50	Float [32b-LSW]	R		42629
V_L23_IH_51	Line Voltage L2-L3 InterHarmonic #51	Float [32b-LSW]	R		42631
V_L23_IH_52	Line Voltage L2-L3 InterHarmonic #52	Float [32b-LSW]	R		42633
V_L23_IH_53	Line Voltage L2-L3 InterHarmonic #53	Float [32b-LSW]	R		42635
V_L23_IH_54	Line Voltage L2-L3 InterHarmonic #54	Float [32b-LSW]	R		42637
V_L23_IH_55	Line Voltage L2-L3 InterHarmonic #55	Float [32b-LSW]	R		42639
V_L23_IH_56	Line Voltage L2-L3 InterHarmonic #56	Float [32b-LSW]	R		42641
V_L23_IH_57	Line Voltage L2-L3 InterHarmonic #57	Float [32b-LSW]	R		42643
V_L23_IH_58	Line Voltage L2-L3 InterHarmonic #58	Float [32b-LSW]	R		42645
V_L23_IH_59	Line Voltage L2-L3 InterHarmonic #59	Float [32b-LSW]	R		42647
V_L23_IH_60	Line Voltage L2-L3 InterHarmonic #60	Float [32b-LSW]	R		42649
V_L23_IH_61	Line Voltage L2-L3 InterHarmonic #61	Float [32b-LSW]	R		42651
V_L23_IH_62	Line Voltage L2-L3 InterHarmonic #62	Float [32b-LSW]	R		42653
V_L23_IH_63	Line Voltage L2-L3 InterHarmonic #63	Float [32b-LSW]	R		42655
V_L31_IH_0	Line Voltage L3-L1 InterHarmonic #0	Float [32b-LSW]	R		42657
V_L31_IH_1	Line Voltage L3-L1 InterHarmonic #1	Float [32b-LSW]	R		42659
V_L31_IH_2	Line Voltage L3-L1 InterHarmonic #2	Float [32b-LSW]	R		42661
V_L31_IH_3	Line Voltage L3-L1 InterHarmonic #3	Float [32b-LSW]	R		42663
V_L31_IH_4	Line Voltage L3-L1 InterHarmonic #4	Float [32b-LSW]	R		42665
V_L31_IH_5	Line Voltage L3-L1 InterHarmonic #5	Float [32b-LSW]	R		42667
V_L31_IH_6	Line Voltage L3-L1 InterHarmonic #6	Float [32b-LSW]	R		42669
V_L31_IH_7	Line Voltage L3-L1 InterHarmonic #7	Float [32b-LSW]	R		42671
V_L31_IH_8	Line Voltage L3-L1 InterHarmonic #8	Float [32b-LSW]	R		42673
V_L31_IH_9	Line Voltage L3-L1 InterHarmonic #9	Float [32b-LSW]	R		42675



Register Name	Description	Register Type	R/W	Default	Address Modbus
V_L31_IH_10	Line Voltage L3-L1 InterHarmonic #10	Float [32b-LSW]	R		42677
V_L31_IH_11	Line Voltage L3-L1 InterHarmonic #11	Float [32b-LSW]	R		42679
V_L31_IH_12	Line Voltage L3-L1 InterHarmonic #12	Float [32b-LSW]	R		42681
V_L31_IH_13	Line Voltage L3-L1 InterHarmonic #13	Float [32b-LSW]	R		42683
V_L31_IH_14	Line Voltage L3-L1 InterHarmonic #14	Float [32b-LSW]	R		42685
V_L31_IH_15	Line Voltage L3-L1 InterHarmonic #15	Float [32b-LSW]	R		42687
V_L31_IH_16	Line Voltage L3-L1 InterHarmonic #16	Float [32b-LSW]	R		42689
V_L31_IH_17	Line Voltage L3-L1 InterHarmonic #17	Float [32b-LSW]	R		42691
V_L31_IH_18	Line Voltage L3-L1 InterHarmonic #18	Float [32b-LSW]	R		42693
V_L31_IH_19	Line Voltage L3-L1 InterHarmonic #19	Float [32b-LSW]	R		42695
V_L31_IH_20	Line Voltage L3-L1 InterHarmonic #20	Float [32b-LSW]	R		42697
V_L31_IH_21	Line Voltage L3-L1 InterHarmonic #21	Float [32b-LSW]	R		42699
V_L31_IH_22	Line Voltage L3-L1 InterHarmonic #22	Float [32b-LSW]	R		42701
V_L31_IH_23	Line Voltage L3-L1 InterHarmonic #23	Float [32b-LSW]	R		42703
V_L31_IH_24	Line Voltage L3-L1 InterHarmonic #24	Float [32b-LSW]	R		42705
V_L31_IH_25	Line Voltage L3-L1 InterHarmonic #25	Float [32b-LSW]	R		42707
V_L31_IH_26	Line Voltage L3-L1 InterHarmonic #26	Float [32b-LSW]	R		42709
V_L31_IH_27	Line Voltage L3-L1 InterHarmonic #27	Float [32b-LSW]	R		42711
V_L31_IH_28	Line Voltage L3-L1 InterHarmonic #28	Float [32b-LSW]	R		42713
V_L31_IH_29	Line Voltage L3-L1 InterHarmonic #29	Float [32b-LSW]	R		42715
V_L31_IH_30	Line Voltage L3-L1 InterHarmonic #30	Float [32b-LSW]	R		42717
V_L31_IH_31	Line Voltage L3-L1 InterHarmonic #31	Float [32b-LSW]	R		42719
V_L31_IH_32	Line Voltage L3-L1 InterHarmonic #32	Float [32b-LSW]	R		42721
V_L31_IH_33	Line Voltage L3-L1 InterHarmonic #33	Float [32b-LSW]	R		42723
V_L31_IH_34	Line Voltage L3-L1 InterHarmonic #34	Float [32b-LSW]	R		42725
V_L31_IH_35	Line Voltage L3-L1 InterHarmonic #35	Float [32b-LSW]	R		42727
V_L31_IH_36	Line Voltage L3-L1 InterHarmonic #36	Float [32b-LSW]	R		42729
V_L31_IH_37	Line Voltage L3-L1 InterHarmonic #37	Float [32b-LSW]	R		42731
V_L31_IH_38	Line Voltage L3-L1 InterHarmonic #38	Float [32b-LSW]	R		42733
V_L31_IH_39	Line Voltage L3-L1 InterHarmonic #39	Float [32b-LSW]	R		42735
V_L31_IH_40	Line Voltage L3-L1 InterHarmonic #40	Float [32b-LSW]	R		42737
V_L31_IH_41	Line Voltage L3-L1 InterHarmonic #41	Float [32b-LSW]	R		42739
V_L31_IH_42	Line Voltage L3-L1 InterHarmonic #42	Float [32b-LSW]	R		42741
V_L31_IH_43	Line Voltage L3-L1 InterHarmonic #43	Float [32b-LSW]	R		42743
V_L31_IH_44	Line Voltage L3-L1 InterHarmonic #44	Float [32b-LSW]	R		42745
V_L31_IH_45	Line Voltage L3-L1 InterHarmonic #45	Float [32b-LSW]	R		42747
V_L31_IH_46	Line Voltage L3-L1 InterHarmonic #46	Float [32b-LSW]	R		42749
V_L31_IH_47	Line Voltage L3-L1 InterHarmonic #47	Float [32b-LSW]	R		42751
V_L31_IH_48	Line Voltage L3-L1 InterHarmonic #48	Float [32b-LSW]	R		42753
V_L31_IH_49	Line Voltage L3-L1 InterHarmonic #49	Float [32b-LSW]	R		42755
V_L31_IH_50	Line Voltage L3-L1 InterHarmonic #50	Float [32b-LSW]	R		42757
V_L31_IH_51	Line Voltage L3-L1 InterHarmonic #51	Float [32b-LSW]	R		42759
V_L31_IH_52	Line Voltage L3-L1 InterHarmonic #52	Float [32b-LSW]	R		42761
V_L31_IH_53	Line Voltage L3-L1 InterHarmonic #53	Float [32b-LSW]	R		42763
V_L31_IH_54	Line Voltage L3-L1 InterHarmonic #54	Float [32b-LSW]	R		42765
V_L31_IH_55	Line Voltage L3-L1 InterHarmonic #55	Float [32b-LSW]	R		42767
V_L31_IH_56	Line Voltage L3-L1 InterHarmonic #56	Float [32b-LSW]	R		42769
V_L31_IH_57	Line Voltage L3-L1 InterHarmonic #57	Float [32b-LSW]	R		42771
V_L31_IH_58	Line Voltage L3-L1 InterHarmonic #58	Float [32b-LSW]	R		42773
V_L31_IH_59	Line Voltage L3-L1 InterHarmonic #59	Float [32b-LSW]	R		42775
V_L31_IH_60	Line Voltage L3-L1 InterHarmonic #60	Float [32b-LSW]	R		42777
V_L31_IH_61	Line Voltage L3-L1 InterHarmonic #61	Float [32b-LSW]	R		42779
V_L31_IH_62	Line Voltage L3-L1 InterHarmonic #62	Float [32b-LSW]	R		42781
V_L31_IH_63	Line Voltage L3-L1 InterHarmonic #63	Float [32b-LSW]	R		42783
I_L1_IH_0	Line Current L1 InterHarmonic #0	Float [32b-LSW]	R		42785
I_L1_IH_1	Line Current L1 InterHarmonic #1	Float [32b-LSW]	R		42787
I_L1_IH_2	Line Current L1 InterHarmonic #2	Float [32b-LSW]	R		42789
I_L1_IH_3	Line Current L1 InterHarmonic #3	Float [32b-LSW]	R		42791
I_L1_IH_4	Line Current L1 InterHarmonic #4	Float [32b-LSW]	R		42793
I_L1_IH_5	Line Current L1 InterHarmonic #5	Float [32b-LSW]	R		42795
I_L1_IH_6	Line Current L1 InterHarmonic #6	Float [32b-LSW]	R		42797
I_L1_IH_7	Line Current L1 InterHarmonic #7	Float [32b-LSW]	R		42799
I_L1_IH_8	Line Current L1 InterHarmonic #8	Float [32b-LSW]	R		42801



Register Name	Description	Register Type	R/W	Default	Address Modbus
I_L1_IH_9	Line Current L1 InterHarmonic #9	Float [32b-LSW]	R		42803
I_L1_IH_10	Line Current L1 InterHarmonic #10	Float [32b-LSW]	R		42805
I_L1_IH_11	Line Current L1 InterHarmonic #11	Float [32b-LSW]	R		42807
I_L1_IH_12	Line Current L1 InterHarmonic #12	Float [32b-LSW]	R		42809
I_L1_IH_13	Line Current L1 InterHarmonic #13	Float [32b-LSW]	R		42811
I_L1_IH_14	Line Current L1 InterHarmonic #14	Float [32b-LSW]	R		42813
I_L1_IH_15	Line Current L1 InterHarmonic #15	Float [32b-LSW]	R		42815
I_L1_IH_16	Line Current L1 InterHarmonic #16	Float [32b-LSW]	R		42817
I_L1_IH_17	Line Current L1 InterHarmonic #17	Float [32b-LSW]	R		42819
I_L1_IH_18	Line Current L1 InterHarmonic #18	Float [32b-LSW]	R		42821
I_L1_IH_19	Line Current L1 InterHarmonic #19	Float [32b-LSW]	R		42823
I_L1_IH_20	Line Current L1 InterHarmonic #20	Float [32b-LSW]	R		42825
I_L1_IH_21	Line Current L1 InterHarmonic #21	Float [32b-LSW]	R		42827
I_L1_IH_22	Line Current L1 InterHarmonic #22	Float [32b-LSW]	R		42829
I_L1_IH_23	Line Current L1 InterHarmonic #23	Float [32b-LSW]	R		42831
I_L1_IH_24	Line Current L1 InterHarmonic #24	Float [32b-LSW]	R		42833
I_L1_IH_25	Line Current L1 InterHarmonic #25	Float [32b-LSW]	R		42835
I_L1_IH_26	Line Current L1 InterHarmonic #26	Float [32b-LSW]	R		42837
I_L1_IH_27	Line Current L1 InterHarmonic #27	Float [32b-LSW]	R		42839
I_L1_IH_28	Line Current L1 InterHarmonic #28	Float [32b-LSW]	R		42841
I_L1_IH_29	Line Current L1 InterHarmonic #29	Float [32b-LSW]	R		42843
I_L1_IH_30	Line Current L1 InterHarmonic #30	Float [32b-LSW]	R		42845
I_L1_IH_31	Line Current L1 InterHarmonic #31	Float [32b-LSW]	R		42847
I_L1_IH_32	Line Current L1 InterHarmonic #32	Float [32b-LSW]	R		42849
I_L1_IH_33	Line Current L1 InterHarmonic #33	Float [32b-LSW]	R		42851
I_L1_IH_34	Line Current L1 InterHarmonic #34	Float [32b-LSW]	R		42853
I_L1_IH_35	Line Current L1 InterHarmonic #35	Float [32b-LSW]	R		42855
I_L1_IH_36	Line Current L1 InterHarmonic #36	Float [32b-LSW]	R		42857
I_L1_IH_37	Line Current L1 InterHarmonic #37	Float [32b-LSW]	R		42859
I_L1_IH_38	Line Current L1 InterHarmonic #38	Float [32b-LSW]	R		42861
I_L1_IH_39	Line Current L1 InterHarmonic #39	Float [32b-LSW]	R		42863
I_L1_IH_40	Line Current L1 InterHarmonic #40	Float [32b-LSW]	R		42865
I_L1_IH_41	Line Current L1 InterHarmonic #41	Float [32b-LSW]	R		42867
I_L1_IH_42	Line Current L1 InterHarmonic #42	Float [32b-LSW]	R		42869
I_L1_IH_43	Line Current L1 InterHarmonic #43	Float [32b-LSW]	R		42871
I_L1_IH_44	Line Current L1 InterHarmonic #44	Float [32b-LSW]	R		42873
I_L1_IH_45	Line Current L1 InterHarmonic #45	Float [32b-LSW]	R		42875
I_L1_IH_46	Line Current L1 InterHarmonic #46	Float [32b-LSW]	R		42877
I_L1_IH_47	Line Current L1 InterHarmonic #47	Float [32b-LSW]	R		42879
I_L1_IH_48	Line Current L1 InterHarmonic #48	Float [32b-LSW]	R		42881
I_L1_IH_49	Line Current L1 InterHarmonic #49	Float [32b-LSW]	R		42883
I_L1_IH_50	Line Current L1 InterHarmonic #50	Float [32b-LSW]	R		42885
I_L1_IH_51	Line Current L1 InterHarmonic #51	Float [32b-LSW]	R		42887
I_L1_IH_52	Line Current L1 InterHarmonic #52	Float [32b-LSW]	R		42889
I_L1_IH_53	Line Current L1 InterHarmonic #53	Float [32b-LSW]	R		42891
I_L1_IH_54	Line Current L1 InterHarmonic #54	Float [32b-LSW]	R		42893
I_L1_IH_55	Line Current L1 InterHarmonic #55	Float [32b-LSW]	R		42895
I_L1_IH_56	Line Current L1 InterHarmonic #56	Float [32b-LSW]	R		42897
I_L1_IH_57	Line Current L1 InterHarmonic #57	Float [32b-LSW]	R		42899
I_L1_IH_58	Line Current L1 InterHarmonic #58	Float [32b-LSW]	R		42901
I_L1_IH_59	Line Current L1 InterHarmonic #59	Float [32b-LSW]	R		42903
I_L1_IH_60	Line Current L1 InterHarmonic #60	Float [32b-LSW]	R		42905
I_L1_IH_61	Line Current L1 InterHarmonic #61	Float [32b-LSW]	R		42907
I_L1_IH_62	Line Current L1 InterHarmonic #62	Float [32b-LSW]	R		42909
I_L1_IH_63	Line Current L1 InterHarmonic #63	Float [32b-LSW]	R		42911
I_L2_IH_0	Line Current L2 InterHarmonic #0	Float [32b-LSW]	R		42913
I_L2_IH_1	Line Current L2 InterHarmonic #1	Float [32b-LSW]	R		42915
I_L2_IH_2	Line Current L2 InterHarmonic #2	Float [32b-LSW]	R		42917
I_L2_IH_3	Line Current L2 InterHarmonic #3	Float [32b-LSW]	R		42919
I_L2_IH_4	Line Current L2 InterHarmonic #4	Float [32b-LSW]	R		42921
I_L2_IH_5	Line Current L2 InterHarmonic #5	Float [32b-LSW]	R		42923
I_L2_IH_6	Line Current L2 InterHarmonic #6	Float [32b-LSW]	R		42925
I_L2_IH_7	Line Current L2 InterHarmonic #7	Float [32b-LSW]	R		42927



Register Name	Description	Register Type	R/W	Default	Address Modbus
I_L2_IH_8	Line Current L2 InterHarmonic #8	Float [32b-LSW]	R		42929
I_L2_IH_9	Line Current L2 InterHarmonic #9	Float [32b-LSW]	R		42931
I_L2_IH_10	Line Current L2 InterHarmonic #10	Float [32b-LSW]	R		42933
I_L2_IH_11	Line Current L2 InterHarmonic #11	Float [32b-LSW]	R		42935
I_L2_IH_12	Line Current L2 InterHarmonic #12	Float [32b-LSW]	R		42937
I_L2_IH_13	Line Current L2 InterHarmonic #13	Float [32b-LSW]	R		42939
I_L2_IH_14	Line Current L2 InterHarmonic #14	Float [32b-LSW]	R		42941
I_L2_IH_15	Line Current L2 InterHarmonic #15	Float [32b-LSW]	R		42943
I_L2_IH_16	Line Current L2 InterHarmonic #16	Float [32b-LSW]	R		42945
I_L2_IH_17	Line Current L2 InterHarmonic #17	Float [32b-LSW]	R		42947
I_L2_IH_18	Line Current L2 InterHarmonic #18	Float [32b-LSW]	R		42949
I_L2_IH_19	Line Current L2 InterHarmonic #19	Float [32b-LSW]	R		42951
I_L2_IH_20	Line Current L2 InterHarmonic #20	Float [32b-LSW]	R		42953
I_L2_IH_21	Line Current L2 InterHarmonic #21	Float [32b-LSW]	R		42955
I_L2_IH_22	Line Current L2 InterHarmonic #22	Float [32b-LSW]	R		42957
I_L2_IH_23	Line Current L2 InterHarmonic #23	Float [32b-LSW]	R		42959
I_L2_IH_24	Line Current L2 InterHarmonic #24	Float [32b-LSW]	R		42961
I_L2_IH_25	Line Current L2 InterHarmonic #25	Float [32b-LSW]	R		42963
I_L2_IH_26	Line Current L2 InterHarmonic #26	Float [32b-LSW]	R		42965
I_L2_IH_27	Line Current L2 InterHarmonic #27	Float [32b-LSW]	R		42967
I_L2_IH_28	Line Current L2 InterHarmonic #28	Float [32b-LSW]	R		42969
I_L2_IH_29	Line Current L2 InterHarmonic #29	Float [32b-LSW]	R		42971
I_L2_IH_30	Line Current L2 InterHarmonic #30	Float [32b-LSW]	R		42973
I_L2_IH_31	Line Current L2 InterHarmonic #31	Float [32b-LSW]	R		42975
I_L2_IH_32	Line Current L2 InterHarmonic #32	Float [32b-LSW]	R		42977
I_L2_IH_33	Line Current L2 InterHarmonic #33	Float [32b-LSW]	R		42979
I_L2_IH_34	Line Current L2 InterHarmonic #34	Float [32b-LSW]	R		42981
I_L2_IH_35	Line Current L2 InterHarmonic #35	Float [32b-LSW]	R		42983
I_L2_IH_36	Line Current L2 InterHarmonic #36	Float [32b-LSW]	R		42985
I_L2_IH_37	Line Current L2 InterHarmonic #37	Float [32b-LSW]	R		42987
I_L2_IH_38	Line Current L2 InterHarmonic #38	Float [32b-LSW]	R		42989
I_L2_IH_39	Line Current L2 InterHarmonic #39	Float [32b-LSW]	R		42991
I_L2_IH_40	Line Current L2 InterHarmonic #40	Float [32b-LSW]	R		42993
I_L2_IH_41	Line Current L2 InterHarmonic #41	Float [32b-LSW]	R		42995
I_L2_IH_42	Line Current L2 InterHarmonic #42	Float [32b-LSW]	R		42997
I_L2_IH_43	Line Current L2 InterHarmonic #43	Float [32b-LSW]	R		42999
I_L2_IH_44	Line Current L2 InterHarmonic #44	Float [32b-LSW]	R		43001
I_L2_IH_45	Line Current L2 InterHarmonic #45	Float [32b-LSW]	R		43003
I_L2_IH_46	Line Current L2 InterHarmonic #46	Float [32b-LSW]	R		43005
I_L2_IH_47	Line Current L2 InterHarmonic #47	Float [32b-LSW]	R		43007
I_L2_IH_48	Line Current L2 InterHarmonic #48	Float [32b-LSW]	R		43009
I_L2_IH_49	Line Current L2 InterHarmonic #49	Float [32b-LSW]	R		43011
I_L2_IH_50	Line Current L2 InterHarmonic #50	Float [32b-LSW]	R		43013
I_L2_IH_51	Line Current L2 InterHarmonic #51	Float [32b-LSW]	R		43015
I_L2_IH_52	Line Current L2 InterHarmonic #52	Float [32b-LSW]	R		43017
I_L2_IH_53	Line Current L2 InterHarmonic #53	Float [32b-LSW]	R		43019
I_L2_IH_54	Line Current L2 InterHarmonic #54	Float [32b-LSW]	R		43021
I_L2_IH_55	Line Current L2 InterHarmonic #55	Float [32b-LSW]	R		43023
I_L2_IH_56	Line Current L2 InterHarmonic #56	Float [32b-LSW]	R		43025
I_L2_IH_57	Line Current L2 InterHarmonic #57	Float [32b-LSW]	R		43027
I_L2_IH_58	Line Current L2 InterHarmonic #58	Float [32b-LSW]	R		43029
I_L2_IH_59	Line Current L2 InterHarmonic #59	Float [32b-LSW]	R		43031
I_L2_IH_60	Line Current L2 InterHarmonic #60	Float [32b-LSW]	R		43033
I_L2_IH_61	Line Current L2 InterHarmonic #61	Float [32b-LSW]	R		43035
I_L2_IH_62	Line Current L2 InterHarmonic #62	Float [32b-LSW]	R		43037
I_L2_IH_63	Line Current L2 InterHarmonic #63	Float [32b-LSW]	R		43039
I_L3_IH_0	Line Current L3 InterHarmonic #0	Float [32b-LSW]	R		43041
I_L3_IH_1	Line Current L3 InterHarmonic #1	Float [32b-LSW]	R		43043
I_L3_IH_2	Line Current L3 InterHarmonic #2	Float [32b-LSW]	R		43045
I_L3_IH_3	Line Current L3 InterHarmonic #3	Float [32b-LSW]	R		43047
I_L3_IH_4	Line Current L3 InterHarmonic #4	Float [32b-LSW]	R		43049
I_L3_IH_5	Line Current L3 InterHarmonic #5	Float [32b-LSW]	R		43051
I_L3_IH_6	Line Current L3 InterHarmonic #6	Float [32b-LSW]	R		43053



Register Name	Description	Register Type	R/W	Default	Address Modbus
I_L3_IH_7	Line Current L3 InterHarmonic #7	Float [32b-LSW]	R		43055
I_L3_IH_8	Line Current L3 InterHarmonic #8	Float [32b-LSW]	R		43057
I_L3_IH_9	Line Current L3 InterHarmonic #9	Float [32b-LSW]	R		43059
I_L3_IH_10	Line Current L3 InterHarmonic #10	Float [32b-LSW]	R		43061
I_L3_IH_11	Line Current L3 InterHarmonic #11	Float [32b-LSW]	R		43063
I_L3_IH_12	Line Current L3 InterHarmonic #12	Float [32b-LSW]	R		43065
I_L3_IH_13	Line Current L3 InterHarmonic #13	Float [32b-LSW]	R		43067
I_L3_IH_14	Line Current L3 InterHarmonic #14	Float [32b-LSW]	R		43069
I_L3_IH_15	Line Current L3 InterHarmonic #15	Float [32b-LSW]	R		43071
I_L3_IH_16	Line Current L3 InterHarmonic #16	Float [32b-LSW]	R		43073
I_L3_IH_17	Line Current L3 InterHarmonic #17	Float [32b-LSW]	R		43075
I_L3_IH_18	Line Current L3 InterHarmonic #18	Float [32b-LSW]	R		43077
I_L3_IH_19	Line Current L3 InterHarmonic #19	Float [32b-LSW]	R		43079
I_L3_IH_20	Line Current L3 InterHarmonic #20	Float [32b-LSW]	R		43081
I_L3_IH_21	Line Current L3 InterHarmonic #21	Float [32b-LSW]	R		43083
I_L3_IH_22	Line Current L3 InterHarmonic #22	Float [32b-LSW]	R		43085
I_L3_IH_23	Line Current L3 InterHarmonic #23	Float [32b-LSW]	R		43087
I_L3_IH_24	Line Current L3 InterHarmonic #24	Float [32b-LSW]	R		43089
I_L3_IH_25	Line Current L3 InterHarmonic #25	Float [32b-LSW]	R		43091
I_L3_IH_26	Line Current L3 InterHarmonic #26	Float [32b-LSW]	R		43093
I_L3_IH_27	Line Current L3 InterHarmonic #27	Float [32b-LSW]	R		43095
I_L3_IH_28	Line Current L3 InterHarmonic #28	Float [32b-LSW]	R		43097
I_L3_IH_29	Line Current L3 InterHarmonic #29	Float [32b-LSW]	R		43099
I_L3_IH_30	Line Current L3 InterHarmonic #30	Float [32b-LSW]	R		43101
I_L3_IH_31	Line Current L3 InterHarmonic #31	Float [32b-LSW]	R		43103
I_L3_IH_32	Line Current L3 InterHarmonic #32	Float [32b-LSW]	R		43105
I_L3_IH_33	Line Current L3 InterHarmonic #33	Float [32b-LSW]	R		43107
I_L3_IH_34	Line Current L3 InterHarmonic #34	Float [32b-LSW]	R		43109
I_L3_IH_35	Line Current L3 InterHarmonic #35	Float [32b-LSW]	R		43111
I_L3_IH_36	Line Current L3 InterHarmonic #36	Float [32b-LSW]	R		43113
I_L3_IH_37	Line Current L3 InterHarmonic #37	Float [32b-LSW]	R		43115
I_L3_IH_38	Line Current L3 InterHarmonic #38	Float [32b-LSW]	R		43117
I_L3_IH_39	Line Current L3 InterHarmonic #39	Float [32b-LSW]	R		43119
I_L3_IH_40	Line Current L3 InterHarmonic #40	Float [32b-LSW]	R		43121
I_L3_IH_41	Line Current L3 InterHarmonic #41	Float [32b-LSW]	R		43123
I_L3_IH_42	Line Current L3 InterHarmonic #42	Float [32b-LSW]	R		43125
I_L3_IH_43	Line Current L3 InterHarmonic #43	Float [32b-LSW]	R		43127
I_L3_IH_44	Line Current L3 InterHarmonic #44	Float [32b-LSW]	R		43129
I_L3_IH_45	Line Current L3 InterHarmonic #45	Float [32b-LSW]	R		43131
I_L3_IH_46	Line Current L3 InterHarmonic #46	Float [32b-LSW]	R		43133
I_L3_IH_47	Line Current L3 InterHarmonic #47	Float [32b-LSW]	R		43135
I_L3_IH_48	Line Current L3 InterHarmonic #48	Float [32b-LSW]	R		43137
I_L3_IH_49	Line Current L3 InterHarmonic #49	Float [32b-LSW]	R		43139
I_L3_IH_50	Line Current L3 InterHarmonic #50	Float [32b-LSW]	R		43141
I_L3_IH_51	Line Current L3 InterHarmonic #51	Float [32b-LSW]	R		43143
I_L3_IH_52	Line Current L3 InterHarmonic #52	Float [32b-LSW]	R		43145
I_L3_IH_53	Line Current L3 InterHarmonic #53	Float [32b-LSW]	R		43147
I_L3_IH_54	Line Current L3 InterHarmonic #54	Float [32b-LSW]	R		43149
I_L3_IH_55	Line Current L3 InterHarmonic #55	Float [32b-LSW]	R		43151
I_L3_IH_56	Line Current L3 InterHarmonic #56	Float [32b-LSW]	R		43153
I_L3_IH_57	Line Current L3 InterHarmonic #57	Float [32b-LSW]	R		43155
I_L3_IH_58	Line Current L3 InterHarmonic #58	Float [32b-LSW]	R		43157
I_L3_IH_59	Line Current L3 InterHarmonic #59	Float [32b-LSW]	R		43159
I_L3_IH_60	Line Current L3 InterHarmonic #60	Float [32b-LSW]	R		43161
I_L3_IH_61	Line Current L3 InterHarmonic #61	Float [32b-LSW]	R		43163
I_L3_IH_62	Line Current L3 InterHarmonic #62	Float [32b-LSW]	R		43165
I_L3_IH_63	Line Current L3 InterHarmonic #63	Float [32b-LSW]	R		43167
I_N_IH_0	Line Current N InterHarmonic #0	Float [32b-LSW]	R		43169
I_N_IH_1	Line Current N InterHarmonic #1	Float [32b-LSW]	R		43171
I_N_IH_2	Line Current N InterHarmonic #2	Float [32b-LSW]	R		43173
I_N_IH_3	Line Current N InterHarmonic #3	Float [32b-LSW]	R		43175
I_N_IH_4	Line Current N InterHarmonic #4	Float [32b-LSW]	R		43177
I_N_IH_5	Line Current N InterHarmonic #5	Float [32b-LSW]	R		43179



Register Name	Description	Register Type	R/W	Default	Address Modbus
I_N_IH_6	Line Current N InterHarmonic #6	Float [32b-LSW]	R		43181
I_N_IH_7	Line Current N InterHarmonic #7	Float [32b-LSW]	R		43183
I_N_IH_8	Line Current N InterHarmonic #8	Float [32b-LSW]	R		43185
I_N_IH_9	Line Current N InterHarmonic #9	Float [32b-LSW]	R		43187
I_N_IH_10	Line Current N InterHarmonic #10	Float [32b-LSW]	R		43189
I_N_IH_11	Line Current N InterHarmonic #11	Float [32b-LSW]	R		43191
I_N_IH_12	Line Current N InterHarmonic #12	Float [32b-LSW]	R		43193
I_N_IH_13	Line Current N InterHarmonic #13	Float [32b-LSW]	R		43195
I_N_IH_14	Line Current N InterHarmonic #14	Float [32b-LSW]	R		43197
I_N_IH_15	Line Current N InterHarmonic #15	Float [32b-LSW]	R		43199
I_N_IH_16	Line Current N InterHarmonic #16	Float [32b-LSW]	R		43201
I_N_IH_17	Line Current N InterHarmonic #17	Float [32b-LSW]	R		43203
I_N_IH_18	Line Current N InterHarmonic #18	Float [32b-LSW]	R		43205
I_N_IH_19	Line Current N InterHarmonic #19	Float [32b-LSW]	R		43207
I_N_IH_20	Line Current N InterHarmonic #20	Float [32b-LSW]	R		43209
I_N_IH_21	Line Current N InterHarmonic #21	Float [32b-LSW]	R		43211
I_N_IH_22	Line Current N InterHarmonic #22	Float [32b-LSW]	R		43213
I_N_IH_23	Line Current N InterHarmonic #23	Float [32b-LSW]	R		43215
I_N_IH_24	Line Current N InterHarmonic #24	Float [32b-LSW]	R		43217
I_N_IH_25	Line Current N InterHarmonic #25	Float [32b-LSW]	R		43219
I_N_IH_26	Line Current N InterHarmonic #26	Float [32b-LSW]	R		43221
I_N_IH_27	Line Current N InterHarmonic #27	Float [32b-LSW]	R		43223
I_N_IH_28	Line Current N InterHarmonic #28	Float [32b-LSW]	R		43225
I_N_IH_29	Line Current N InterHarmonic #29	Float [32b-LSW]	R		43227
I_N_IH_30	Line Current N InterHarmonic #30	Float [32b-LSW]	R		43229
I_N_IH_31	Line Current N InterHarmonic #31	Float [32b-LSW]	R		43231
I_N_IH_32	Line Current N InterHarmonic #32	Float [32b-LSW]	R		43233
I_N_IH_33	Line Current N InterHarmonic #33	Float [32b-LSW]	R		43235
I_N_IH_34	Line Current N InterHarmonic #34	Float [32b-LSW]	R		43237
I_N_IH_35	Line Current N InterHarmonic #35	Float [32b-LSW]	R		43239
I_N_IH_36	Line Current N InterHarmonic #36	Float [32b-LSW]	R		43241
I_N_IH_37	Line Current N InterHarmonic #37	Float [32b-LSW]	R		43243
I_N_IH_38	Line Current N InterHarmonic #38	Float [32b-LSW]	R		43245
I_N_IH_39	Line Current N InterHarmonic #39	Float [32b-LSW]	R		43247
I_N_IH_40	Line Current N InterHarmonic #40	Float [32b-LSW]	R		43249
I_N_IH_41	Line Current N InterHarmonic #41	Float [32b-LSW]	R		43251
I_N_IH_42	Line Current N InterHarmonic #42	Float [32b-LSW]	R		43253
I_N_IH_43	Line Current N InterHarmonic #43	Float [32b-LSW]	R		43255
I_N_IH_44	Line Current N InterHarmonic #44	Float [32b-LSW]	R		43257
I_N_IH_45	Line Current N InterHarmonic #45	Float [32b-LSW]	R		43259
I_N_IH_46	Line Current N InterHarmonic #46	Float [32b-LSW]	R		43261
I_N_IH_47	Line Current N InterHarmonic #47	Float [32b-LSW]	R		43263
I_N_IH_48	Line Current N InterHarmonic #48	Float [32b-LSW]	R		43265
I_N_IH_49	Line Current N InterHarmonic #49	Float [32b-LSW]	R		43267
I_N_IH_50	Line Current N InterHarmonic #50	Float [32b-LSW]	R		43269
I_N_IH_51	Line Current N InterHarmonic #51	Float [32b-LSW]	R		43271
I_N_IH_52	Line Current N InterHarmonic #52	Float [32b-LSW]	R		43273
I_N_IH_53	Line Current N InterHarmonic #53	Float [32b-LSW]	R		43275
I_N_IH_54	Line Current N InterHarmonic #54	Float [32b-LSW]	R		43277
I_N_IH_55	Line Current N InterHarmonic #55	Float [32b-LSW]	R		43279
I_N_IH_56	Line Current N InterHarmonic #56	Float [32b-LSW]	R		43281
I_N_IH_57	Line Current N InterHarmonic #57	Float [32b-LSW]	R		43283
I_N_IH_58	Line Current N InterHarmonic #58	Float [32b-LSW]	R		43285
I_N_IH_59	Line Current N InterHarmonic #59	Float [32b-LSW]	R		43287
I_N_IH_60	Line Current N InterHarmonic #60	Float [32b-LSW]	R		43289
I_N_IH_61	Line Current N InterHarmonic #61	Float [32b-LSW]	R		43291
I_N_IH_62	Line Current N InterHarmonic #62	Float [32b-LSW]	R		43293
I_N_IH_63	Line Current N InterHarmonic #63	Float [32b-LSW]	R		43295
V_SAG_VALUE_N_0	Voltage Sag RMS Value (between 10% and 90% "Nominal_Star_Voltage") @ n-0	Float [32b-LSW]	R		43297
V_SAG_YEAR_N_0	Voltage Sag Year @ n-0	UShort [16b]	R		43299
V_SAG_MONTH_N_0	Voltage Sag Month @ n-0	UShort [16b]	R		43300
V_SAG_DAY_N_0	Voltage Sag Day @ n-0	UShort [16b]	R		43301



Register Name	Description	Register Type	R/W	Default	Address Modbus
V_SAG_HOUR_N_0	Voltage Sag Hour @ n-0	UShort [16b]	R		43302
V_SAG_MINUTE_N_0	Voltage Sag Minute @ n-0	UShort [16b]	R		43303
V_SAG_SECOND_N_0	Voltage Sag Second @ n-0	UShort [16b]	R		43304
V_SAG_DURATION_N_0	Voltage Sag Duration [ms] @ n-0	UShort [16b]	R		43305
V_SAG_QUERY_N_0	Voltage Sag Type: 0: ND 1: V_L1N 2: V_L2N 3: V_L3N 4: V_L1L2 5: V_L2L3 6: V_L3L1	UShort [16b]	R		43306
V_SAG_VALUE_N_1	Voltage Sag RMS Value (between 10% and 90% "Nominal_Star_Voltage") @ n-1	Float [32b-LSW]	R		43307
V_SAG_YEAR_N_1	Voltage Sag Year @ n-1	UShort [16b]	R		43309
V_SAG_MONTH_N_1	Voltage Sag Month @ n-1	UShort [16b]	R		43310
V_SAG_DAY_N_1	Voltage Sag Day @ n-1	UShort [16b]	R		43311
V_SAG_HOUR_N_1	Voltage Sag Hour @ n-1	UShort [16b]	R		43312
V_SAG_MINUTE_N_1	Voltage Sag Minute @ n-1	UShort [16b]	R		43313
V_SAG_SECOND_N_1	Voltage Sag Second @ n-1	UShort [16b]	R		43314
V_SAG_DURATION_N_1	Voltage Sag Duration [ms] @ n-1	UShort [16b]	R		43315
V_SAG_QUERY_N_1	Voltage Sag Type: 0: ND 1: V_L1N 2: V_L2N 3: V_L3N 4: V_L1L2 5: V_L2L3 6: V_L3L1	UShort [16b]	R		43316
V_SAG_VALUE_N_2	Voltage Sag RMS Value (between 10% and 90% "Nominal_Star_Voltage") @ n-2	Float [32b-LSW]	R		43317
V_SAG_YEAR_N_2	Voltage Sag Year @ n-2	UShort [16b]	R		43319
V_SAG_MONTH_N_2	Voltage Sag Month @ n-2	UShort [16b]	R		43320
V_SAG_DAY_N_2	Voltage Sag Day @ n-2	UShort [16b]	R		43321
V_SAG_HOUR_N_2	Voltage Sag Hour @ n-2	UShort [16b]	R		43322
V_SAG_MINUTE_N_2	Voltage Sag Minute @ n-2	UShort [16b]	R		43323
V_SAG_SECOND_N_2	Voltage Sag Second @ n-2	UShort [16b]	R		43324
V_SAG_DURATION_N_2	Voltage Sag Duration [ms] @ n-2	UShort [16b]	R		43325
V_SAG_QUERY_N_2	Voltage Sag Type: 0: ND 1: V_L1N 2: V_L2N 3: V_L3N 4: V_L1L2 5: V_L2L3 6: V_L3L1	UShort [16b]	R		43326
V_SAG_VALUE_N_3	Voltage Sag RMS Value (between 10% and 90% "Nominal_Star_Voltage") @ n-3	Float [32b-LSW]	R		43327
V_SAG_YEAR_N_3	Voltage Sag Year @ n-3	UShort [16b]	R		43329
V_SAG_MONTH_N_3	Voltage Sag Month @ n-3	UShort [16b]	R		43330
V_SAG_DAY_N_3	Voltage Sag Day @ n-3	UShort [16b]	R		43331
V_SAG_HOUR_N_3	Voltage Sag Hour @ n-3	UShort [16b]	R		43332
V_SAG_MINUTE_N_3	Voltage Sag Minute @ n-3	UShort [16b]	R		43333
V_SAG_SECOND_N_3	Voltage Sag Second @ n-3	UShort [16b]	R		43334
V_SAG_DURATION_N_3	Voltage Sag Duration [ms] @ n-3	UShort [16b]	R		43335
V_SAG_QUERY_N_3	Voltage Sag Type: 0: ND 1: V_L1N 2: V_L2N 3: V_L3N 4: V_L1L2 5: V_L2L3 6: V_L3L1	UShort [16b]	R		43336
V_SAG_VALUE_N_4	Voltage Sag RMS Value (between 10% and 90% "Nominal_Star_Voltage") @ n-4	Float [32b-LSW]	R		43337
V_SAG_YEAR_N_4	Voltage Sag Year @ n-4	UShort [16b]	R		43339
V_SAG_MONTH_N_4	Voltage Sag Month @ n-4	UShort [16b]	R		43340
V_SAG_DAY_N_4	Voltage Sag Day @ n-4	UShort [16b]	R		43341
V_SAG_HOUR_N_4	Voltage Sag Hour @ n-4	UShort [16b]	R		43342
V_SAG_MINUTE_N_4	Voltage Sag Minute @ n-4	UShort [16b]	R		43343



Register Name	Description	Register Type	R/W	Default	Address Modbus
V_SAG_SECOND_N_4	Voltage Sag Second @ n-4	UShort [16b]	R		43344
V_SAG_DURATION_N_4	Voltage Sag Duration [ms] @ n-4	UShort [16b]	R		43345
V_SAG_QUERY_N_4	Voltage Sag Type: 0: ND 1: V_L1N 2: V_L2N 3: V_L3N 4: V_L1L2 5: V_L2L3 6: V_L3L1	UShort [16b]	R		43346
V_SAG_VALUE_N_5	Voltage Sag RMS Value (between 10% and 90% "Nominal_Star_Voltage") @ n-5	Float [32b-LSW]	R		43347
V_SAG_YEAR_N_5	Voltage Sag Year @ n-5	UShort [16b]	R		43349
V_SAG_MONTH_N_5	Voltage Sag Month @ n-5	UShort [16b]	R		43350
V_SAG_DAY_N_5	Voltage Sag Day @ n-5	UShort [16b]	R		43351
V_SAG_HOUR_N_5	Voltage Sag Hour @ n-5	UShort [16b]	R		43352
V_SAG_MINUTE_N_5	Voltage Sag Minute @ n-5	UShort [16b]	R		43353
V_SAG_SECOND_N_5	Voltage Sag Second @ n-5	UShort [16b]	R		43354
V_SAG_DURATION_N_5	Voltage Sag Duration [ms] @ n-5	UShort [16b]	R		43355
V_SAG_QUERY_N_5	Voltage Sag Type: 0: ND 1: V_L1N 2: V_L2N 3: V_L3N 4: V_L1L2 5: V_L2L3 6: V_L3L1	UShort [16b]	R		43356
V_SAG_VALUE_N_6	Voltage Sag RMS Value (between 10% and 90% "Nominal_Star_Voltage") @ n-6	Float [32b-LSW]	R		43357
V_SAG_YEAR_N_6	Voltage Sag Year @ n-6	UShort [16b]	R		43359
V_SAG_MONTH_N_6	Voltage Sag Month @ n-6	UShort [16b]	R		43360
V_SAG_DAY_N_6	Voltage Sag Day @ n-6	UShort [16b]	R		43361
V_SAG_HOUR_N_6	Voltage Sag Hour @ n-6	UShort [16b]	R		43362
V_SAG_MINUTE_N_6	Voltage Sag Minute @ n-6	UShort [16b]	R		43363
V_SAG_SECOND_N_6	Voltage Sag Second @ n-6	UShort [16b]	R		43364
V_SAG_DURATION_N_6	Voltage Sag Duration [ms] @ n-6	UShort [16b]	R		43365
V_SAG_QUERY_N_6	Voltage Sag Type: 0: ND 1: V_L1N 2: V_L2N 3: V_L3N 4: V_L1L2 5: V_L2L3 6: V_L3L1	UShort [16b]	R		43366
V_SAG_VALUE_N_7	Voltage Sag RMS Value (between 10% and 90% "Nominal_Star_Voltage") @ n-7	Float [32b-LSW]	R		43367
V_SAG_YEAR_N_7	Voltage Sag Year @ n-7	UShort [16b]	R		43369
V_SAG_MONTH_N_7	Voltage Sag Month @ n-7	UShort [16b]	R		43370
V_SAG_DAY_N_7	Voltage Sag Day @ n-7	UShort [16b]	R		43371
V_SAG_HOUR_N_7	Voltage Sag Hour @ n-7	UShort [16b]	R		43372
V_SAG_MINUTE_N_7	Voltage Sag Minute @ n-7	UShort [16b]	R		43373
V_SAG_SECOND_N_7	Voltage Sag Second @ n-7	UShort [16b]	R		43374
V_SAG_DURATION_N_7	Voltage Sag Duration [ms] @ n-7	UShort [16b]	R		43375
V_SAG_QUERY_N_7	Voltage Sag Type: 0: ND 1: V_L1N 2: V_L2N 3: V_L3N 4: V_L1L2 5: V_L2L3 6: V_L3L1	UShort [16b]	R		43376
V_SAG_VALUE_N_8	Voltage Sag RMS Value (between 10% and 90% "Nominal_Star_Voltage") @ n-8	Float [32b-LSW]	R		43377
V_SAG_YEAR_N_8	Voltage Sag Year @ n-8	UShort [16b]	R		43379
V_SAG_MONTH_N_8	Voltage Sag Month @ n-8	UShort [16b]	R		43380
V_SAG_DAY_N_8	Voltage Sag Day @ n-8	UShort [16b]	R		43381
V_SAG_HOUR_N_8	Voltage Sag Hour @ n-8	UShort [16b]	R		43382
V_SAG_MINUTE_N_8	Voltage Sag Minute @ n-8	UShort [16b]	R		43383
V_SAG_SECOND_N_8	Voltage Sag Second @ n-8	UShort [16b]	R		43384
V_SAG_DURATION_N_8	Voltage Sag Duration [ms] @ n-8	UShort [16b]	R		43385



Register Name	Description	Register Type	R/W	Default	Address Modbus
V_SAG_QUERY_N_8	Voltage Sag Type: 0: ND 1: V_L1N 2: V_L2N 3: V_L3N 4: V_L1L2 5: V_L2L3 6: V_L3L1	UShort [16b]	R		43386
V_SAG_VALUE_N_9	Voltage Sag RMS Value (between 10% and 90% "Nominal_Star_Voltage") @ n-9	Float [32b-LSW]	R		43387
V_SAG_YEAR_N_9	Voltage Sag Year @ n-9	UShort [16b]	R		43389
V_SAG_MONTH_N_9	Voltage Sag Month @ n-9	UShort [16b]	R		43390
V_SAG_DAY_N_9	Voltage Sag Day @ n-9	UShort [16b]	R		43391
V_SAG_HOUR_N_9	Voltage Sag Hour @ n-9	UShort [16b]	R		43392
V_SAG_MINUTE_N_9	Voltage Sag Minute @ n-9	UShort [16b]	R		43393
V_SAG_SECOND_N_9	Voltage Sag Second @ n-9	UShort [16b]	R		43394
V_SAG_DURATION_N_9	Voltage Sag Duration [ms] @ n-9	UShort [16b]	R		43395
V_SAG_QUERY_N_9	Voltage Sag Type: 0: ND 1: V_L1N 2: V_L2N 3: V_L3N 4: V_L1L2 5: V_L2L3 6: V_L3L1	UShort [16b]	R		43396
V_SAG_VALUE_EEPROM	Voltage Sag RMS Value (between 10% and 90% "Nominal_Star_Voltage") EEPROM data	Float [32b-LSW]	R		43397
V_SAG_YEAR_EEPROM	Voltage Sag Year EEPROM data	UShort [16b]	R		43399
V_SAG_MONTH_EEPROM	Voltage Sag Month EEPROM data	UShort [16b]	R		43400
V_SAG_DAY_EEPROM	Voltage Sag Day EEPROM data	UShort [16b]	R		43401
V_SAG_HOUR_EEPROM	Voltage Sag Hour EEPROM data	UShort [16b]	R		43402
V_SAG_MINUTE_EEPROM	Voltage Sag Minute EEPROM data	UShort [16b]	R		43403
V_SAG_SECOND_EEPROM	Voltage Sag Second EEPROM data	UShort [16b]	R		43404
V_SAG_DURATION_EEPROM	Voltage Sag Duration [ms] EEPROM data	UShort [16b]	R		43405
V_SAG_QUERY_EEPROM	Voltage Sag Type: 0: ND 1: V_L1N 2: V_L2N 3: V_L3N 4: V_L1L2 5: V_L2L3 6: V_L3L1	UShort [16b]	R		43406
V_SWELL_VALUE_N_0	Voltage Swell RMS Value (between 10% and 90% "Nominal_Star_Voltage") @ n-0	Float [32b-LSW]	R		43407
V_SWELL_YEAR_N_0	Voltage Swell Year @ n-0	UShort [16b]	R		43409
V_SWELL_MONTH_N_0	Voltage Swell Month @ n-0	UShort [16b]	R		43410
V_SWELL_DAY_N_0	Voltage Swell Day @ n-0	UShort [16b]	R		43411
V_SWELL_HOUR_N_0	Voltage Swell Hour @ n-0	UShort [16b]	R		43412
V_SWELL_MINUTE_N_0	Voltage Swell Minute @ n-0	UShort [16b]	R		43413
V_SWELL_SECOND_N_0	Voltage Swell Second @ n-0	UShort [16b]	R		43414
V_SWELL_DURATION_N_0	Voltage Swell Duration [ms] @ n-0	UShort [16b]	R		43415
V_SWELL_QUERY_N_0	Voltage Sag Type: 0: ND 1: V_L1N 2: V_L2N 3: V_L3N 4: V_L1L2 5: V_L2L3 6: V_L3L1	UShort [16b]	R		43416
V_SWELL_VALUE_N_1	Voltage Swell RMS Value (between 10% and 90% "Nominal_Star_Voltage") @ n-1	Float [32b-LSW]	R		43417
V_SWELL_YEAR_N_1	Voltage Swell Year @ n-1	UShort [16b]	R		43419
V_SWELL_MONTH_N_1	Voltage Swell Month @ n-1	UShort [16b]	R		43420
V_SWELL_DAY_N_1	Voltage Swell Day @ n-1	UShort [16b]	R		43421
V_SWELL_HOUR_N_1	Voltage Swell Hour @ n-1	UShort [16b]	R		43422
V_SWELL_MINUTE_N_1	Voltage Swell Minute @ n-1	UShort [16b]	R		43423
V_SWELL_SECOND_N_1	Voltage Swell Second @ n-1	UShort [16b]	R		43424
V_SWELL_DURATION_N_1	Voltage Swell Duration [ms] @ n-1	UShort [16b]	R		43425



Register Name	Description	Register Type	R/W	Default	Address Modbus
V_SWELL_QUERY_N_1	Voltage Sag Type: 0: ND 1: V_L1N 2: V_L2N 3: V_L3N 4: V_L1L2 5: V_L2L3 6: V_L3L1	UShort [16b]	R		43426
V_SWELL_VALUE_N_2	Voltage Swell RMS Value (between 10% and 90% "Nominal_Star_Voltage") @ n-2	Float [32b-LSW]	R		43427
V_SWELL_YEAR_N_2	Voltage Swell Year @ n-2	UShort [16b]	R		43429
V_SWELL_MONTH_N_2	Voltage Swell Month @ n-2	UShort [16b]	R		43430
V_SWELL_DAY_N_2	Voltage Swell Day @ n-2	UShort [16b]	R		43431
V_SWELL_HOUR_N_2	Voltage Swell Hour @ n-2	UShort [16b]	R		43432
V_SWELL_MINUTE_N_2	Voltage Swell Minute @ n-2	UShort [16b]	R		43433
V_SWELL_SECOND_N_2	Voltage Swell Second @ n-2	UShort [16b]	R		43434
V_SWELL_DURATION_N_2	Voltage Swell Duration [ms] @ n-2	UShort [16b]	R		43435
V_SWELL_QUERY_N_2	Voltage Sag Type: 0: ND 1: V_L1N 2: V_L2N 3: V_L3N 4: V_L1L2 5: V_L2L3 6: V_L3L1	UShort [16b]	R		43436
V_SWELL_VALUE_N_3	Voltage Swell RMS Value (between 10% and 90% "Nominal_Star_Voltage") @ n-3	Float [32b-LSW]	R		43437
V_SWELL_YEAR_N_3	Voltage Swell Year @ n-3	UShort [16b]	R		43439
V_SWELL_MONTH_N_3	Voltage Swell Month @ n-3	UShort [16b]	R		43440
V_SWELL_DAY_N_3	Voltage Swell Day @ n-3	UShort [16b]	R		43441
V_SWELL_HOUR_N_3	Voltage Swell Hour @ n-3	UShort [16b]	R		43442
V_SWELL_MINUTE_N_3	Voltage Swell Minute @ n-3	UShort [16b]	R		43443
V_SWELL_SECOND_N_3	Voltage Swell Second @ n-3	UShort [16b]	R		43444
V_SWELL_DURATION_N_3	Voltage Swell Duration [ms] @ n-3	UShort [16b]	R		43445
V_SWELL_QUERY_N_3	Voltage Sag Type: 0: ND 1: V_L1N 2: V_L2N 3: V_L3N 4: V_L1L2 5: V_L2L3 6: V_L3L1	UShort [16b]	R		43446
V_SWELL_VALUE_N_4	Voltage Swell RMS Value (between 10% and 90% "Nominal_Star_Voltage") @ n-4	Float [32b-LSW]	R		43447
V_SWELL_YEAR_N_4	Voltage Swell Year @ n-4	UShort [16b]	R		43449
V_SWELL_MONTH_N_4	Voltage Swell Month @ n-4	UShort [16b]	R		43450
V_SWELL_DAY_N_4	Voltage Swell Day @ n-4	UShort [16b]	R		43451
V_SWELL_HOUR_N_4	Voltage Swell Hour @ n-4	UShort [16b]	R		43452
V_SWELL_MINUTE_N_4	Voltage Swell Minute @ n-4	UShort [16b]	R		43453
V_SWELL_SECOND_N_4	Voltage Swell Second @ n-4	UShort [16b]	R		43454
V_SWELL_DURATION_N_4	Voltage Swell Duration [ms] @ n-4	UShort [16b]	R		43455
V_SWELL_QUERY_N_4	Voltage Sag Type: 0: ND 1: V_L1N 2: V_L2N 3: V_L3N 4: V_L1L2 5: V_L2L3 6: V_L3L1	UShort [16b]	R		43456
V_SWELL_VALUE_N_5	Voltage Swell RMS Value (between 10% and 90% "Nominal_Star_Voltage") @ n-5	Float [32b-LSW]	R		43457
V_SWELL_YEAR_N_5	Voltage Swell Year @ n-5	UShort [16b]	R		43459
V_SWELL_MONTH_N_5	Voltage Swell Month @ n-5	UShort [16b]	R		43460
V_SWELL_DAY_N_5	Voltage Swell Day @ n-5	UShort [16b]	R		43461
V_SWELL_HOUR_N_5	Voltage Swell Hour @ n-5	UShort [16b]	R		43462
V_SWELL_MINUTE_N_5	Voltage Swell Minute @ n-5	UShort [16b]	R		43463
V_SWELL_SECOND_N_5	Voltage Swell Second @ n-5	UShort [16b]	R		43464
V_SWELL_DURATION_N_5	Voltage Swell Duration [ms] @ n-5	UShort [16b]	R		43465



Register Name	Description	Register Type	R/W	Default	Address Modbus
V_SWELL_QUERY_N_5	Voltage Sag Type: 0: ND 1: V_L1N 2: V_L2N 3: V_L3N 4: V_L1L2 5: V_L2L3 6: V_L3L1	UShort [16b]	R		43466
V_SWELL_VALUE_N_6	Voltage Swell RMS Value (between 10% and 90% "Nominal_Star_Voltage") @ n-6	Float [32b-LSW]	R		43467
V_SWELL_YEAR_N_6	Voltage Swell Year @ n-6	UShort [16b]	R		43469
V_SWELL_MONTH_N_6	Voltage Swell Month @ n-6	UShort [16b]	R		43470
V_SWELL_DAY_N_6	Voltage Swell Day @ n-6	UShort [16b]	R		43471
V_SWELL_HOUR_N_6	Voltage Swell Hour @ n-6	UShort [16b]	R		43472
V_SWELL_MINUTE_N_6	Voltage Swell Minute @ n-6	UShort [16b]	R		43473
V_SWELL_SECOND_N_6	Voltage Swell Second @ n-6	UShort [16b]	R		43474
V_SWELL_DURATION_N_6	Voltage Swell Duration [ms] @ n-6	UShort [16b]	R		43475
V_SWELL_QUERY_N_6	Voltage Sag Type: 0: ND 1: V_L1N 2: V_L2N 3: V_L3N 4: V_L1L2 5: V_L2L3 6: V_L3L1	UShort [16b]	R		43476
V_SWELL_VALUE_N_7	Voltage Swell RMS Value (between 10% and 90% "Nominal_Star_Voltage") @ n-7	Float [32b-LSW]	R		43477
V_SWELL_YEAR_N_7	Voltage Swell Year @ n-7	UShort [16b]	R		43479
V_SWELL_MONTH_N_7	Voltage Swell Month @ n-7	UShort [16b]	R		43480
V_SWELL_DAY_N_7	Voltage Swell Day @ n-7	UShort [16b]	R		43481
V_SWELL_HOUR_N_7	Voltage Swell Hour @ n-7	UShort [16b]	R		43482
V_SWELL_MINUTE_N_7	Voltage Swell Minute @ n-7	UShort [16b]	R		43483
V_SWELL_SECOND_N_7	Voltage Swell Second @ n-7	UShort [16b]	R		43484
V_SWELL_DURATION_N_7	Voltage Swell Duration [ms] @ n-7	UShort [16b]	R		43485
V_SWELL_QUERY_N_7	Voltage Sag Type: 0: ND 1: V_L1N 2: V_L2N 3: V_L3N 4: V_L1L2 5: V_L2L3 6: V_L3L1	UShort [16b]	R		43486
V_SWELL_VALUE_N_8	Voltage Swell RMS Value (between 10% and 90% "Nominal_Star_Voltage") @ n-8	Float [32b-LSW]	R		43487
V_SWELL_YEAR_N_8	Voltage Swell Year @ n-8	UShort [16b]	R		43489
V_SWELL_MONTH_N_8	Voltage Swell Month @ n-8	UShort [16b]	R		43490
V_SWELL_DAY_N_8	Voltage Swell Day @ n-8	UShort [16b]	R		43491
V_SWELL_HOUR_N_8	Voltage Swell Hour @ n-8	UShort [16b]	R		43492
V_SWELL_MINUTE_N_8	Voltage Swell Minute @ n-8	UShort [16b]	R		43493
V_SWELL_SECOND_N_8	Voltage Swell Second @ n-8	UShort [16b]	R		43494
V_SWELL_DURATION_N_8	Voltage Swell Duration [ms] @ n-8	UShort [16b]	R		43495
V_SWELL_QUERY_N_8	Voltage Sag Type: 0: ND 1: V_L1N 2: V_L2N 3: V_L3N 4: V_L1L2 5: V_L2L3 6: V_L3L1	UShort [16b]	R		43496
V_SWELL_VALUE_N_9	Voltage Swell RMS Value (between 10% and 90% "Nominal_Star_Voltage") @ n-9	Float [32b-LSW]	R		43497
V_SWELL_YEAR_N_9	Voltage Swell Year @ n-9	UShort [16b]	R		43499
V_SWELL_MONTH_N_9	Voltage Swell Month @ n-9	UShort [16b]	R		43500
V_SWELL_DAY_N_9	Voltage Swell Day @ n-9	UShort [16b]	R		43501
V_SWELL_HOUR_N_9	Voltage Swell Hour @ n-9	UShort [16b]	R		43502
V_SWELL_MINUTE_N_9	Voltage Swell Minute @ n-9	UShort [16b]	R		43503
V_SWELL_SECOND_N_9	Voltage Swell Second @ n-9	UShort [16b]	R		43504
V_SWELL_DURATION_N_9	Voltage Swell Duration [ms] @ n-9	UShort [16b]	R		43505



Register Name	Description	Register Type	R/W	Default	Address Modbus
V_SWELL_QUERY_N_9	Voltage Sag Type: 0: ND 1: V_L1N 2: V_L2N 3: V_L3N 4: V_L1L2 5: V_L2L3 6: V_L3L1	UShort [16b]	R		43506
V_SWELL_VALUE_EEPROM	Voltage Swell RMS Value (between 10% and 90% "Nominal_Star_Voltage") EEPROM data	Float [32b-LSW]	R		43507
V_SWELL_YEAR_EEPROM	Voltage Swell Year EEPROM data	UShort [16b]	R		43509
V_SWELL_MONTH_EEPROM	Voltage Swell Month EEPROM data	UShort [16b]	R		43510
V_SWELL_DAY_EEPROM	Voltage Swell Day EEPROM data	UShort [16b]	R		43511
V_SWELL_HOUR_EEPROM	Voltage Swell Hour EEPROM data	UShort [16b]	R		43512
V_SWELL_MINUTE_EEPROM	Voltage Swell Minute EEPROM data	UShort [16b]	R		43513
V_SWELL_SECOND_EEPROM	Voltage Swell Second EEPROM data	UShort [16b]	R		43514
V_SWELL_DURATION_EEPROM	Voltage Swell Duration [ms] EEPROM data	UShort [16b]	R		43515
V_SWELL_QUERY_EEPROM	Voltage Sag Type: 0: ND 1: V_L1N 2: V_L2N 3: V_L3N 4: V_L1L2 5: V_L2L3 6: V_L3L1	UShort [16b]	R		43516
V_INTERRUPTION_VALUE_N_0	Voltage Interruption RMS Value (between 10% and 90% "Nominal_Star_Voltage") @ n-0	Float [32b-LSW]	R		43517
V_INTERRUPTION_YEAR_N_0	Voltage Interruption Year @ n-0	UShort [16b]	R		43519
V_INTERRUPTION_MONTH_N_0	Voltage Interruption Month @ n-0	UShort [16b]	R		43520
V_INTERRUPTION_DAY_N_0	Voltage Interruption Day @ n-0	UShort [16b]	R		43521
V_INTERRUPTION_HOUR_N_0	Voltage Interruption Hour @ n-0	UShort [16b]	R		43522
V_INTERRUPTION_MINUTE_N_0	Voltage Interruption Minute @ n-0	UShort [16b]	R		43523
V_INTERRUPTION_SECOND_N_0	Voltage Interruption Second @ n-0	UShort [16b]	R		43524
V_INTERRUPTION_DURATION_N_0	Voltage Interruption Duration [ms] @ n-0	UShort [16b]	R		43525
V_INTERRUPTION_QUERY_N_0	Voltage Sag Type: 0: ND 1: V_L1N 2: V_L2N 3: V_L3N 4: V_L1L2 5: V_L2L3 6: V_L3L1	UShort [16b]	R		43526
V_INTERRUPTION_VALUE_N_1	Voltage Interruption RMS Value (between 10% and 90% "Nominal_Star_Voltage") @ n-1	Float [32b-LSW]	R		43527
V_INTERRUPTION_YEAR_N_1	Voltage Interruption Year @ n-1	UShort [16b]	R		43529
V_INTERRUPTION_MONTH_N_1	Voltage Interruption Month @ n-1	UShort [16b]	R		43530
V_INTERRUPTION_DAY_N_1	Voltage Interruption Day @ n-1	UShort [16b]	R		43531
V_INTERRUPTION_HOUR_N_1	Voltage Interruption Hour @ n-1	UShort [16b]	R		43532
V_INTERRUPTION_MINUTE_N_1	Voltage Interruption Minute @ n-1	UShort [16b]	R		43533
V_INTERRUPTION_SECOND_N_1	Voltage Interruption Second @ n-1	UShort [16b]	R		43534
V_INTERRUPTION_DURATION_N_1	Voltage Interruption Duration [ms] @ n-1	UShort [16b]	R		43535
V_INTERRUPTION_QUERY_N_1	Voltage Sag Type: 0: ND 1: V_L1N 2: V_L2N 3: V_L3N 4: V_L1L2 5: V_L2L3 6: V_L3L1	UShort [16b]	R		43536
V_INTERRUPTION_VALUE_N_2	Voltage Interruption RMS Value (between 10% and 90% "Nominal_Star_Voltage") @ n-2	Float [32b-LSW]	R		43537
V_INTERRUPTION_YEAR_N_2	Voltage Interruption Year @ n-2	UShort [16b]	R		43539
V_INTERRUPTION_MONTH_N_2	Voltage Interruption Month @ n-2	UShort [16b]	R		43540
V_INTERRUPTION_DAY_N_2	Voltage Interruption Day @ n-2	UShort [16b]	R		43541
V_INTERRUPTION_HOUR_N_2	Voltage Interruption Hour @ n-2	UShort [16b]	R		43542
V_INTERRUPTION_MINUTE_N_2	Voltage Interruption Minute @ n-2	UShort [16b]	R		43543
V_INTERRUPTION_SECOND_N_2	Voltage Interruption Second @ n-2	UShort [16b]	R		43544
V_INTERRUPTION_DURATION_N_2	Voltage Interruption Duration [ms] @ n-2	UShort [16b]	R		43545



Register Name	Description	Register Type	R/W	Default	Address Modbus
V_INTERRUPTION_QUERY_N_2	Voltage Sag Type: 0: ND 1: V_L1N 2: V_L2N 3: V_L3N 4: V_L1L2 5: V_L2L3 6: V_L3L1	UShort [16b]	R		43546
V_INTERRUPTION_VALUE_N_3	Voltage Interruption RMS Value (between 10% and 90% "Nominal_Star_Voltage") @ n-3	Float [32b-LSW]	R		43547
V_INTERRUPTION_YEAR_N_3	Voltage Interruption Year @ n-3	UShort [16b]	R		43549
V_INTERRUPTION_MONTH_N_3	Voltage Interruption Month @ n-3	UShort [16b]	R		43550
V_INTERRUPTION_DAY_N_3	Voltage Interruption Day @ n-3	UShort [16b]	R		43551
V_INTERRUPTION_HOUR_N_3	Voltage Interruption Hour @ n-3	UShort [16b]	R		43552
V_INTERRUPTION_MINUTE_N_3	Voltage Interruption Minute @ n-3	UShort [16b]	R		43553
V_INTERRUPTION_SECONDS_N_3	Voltage Interruption Second @ n-3	UShort [16b]	R		43554
V_INTERRUPTION_DURATION_N_3	Voltage Interruption Duration [ms] @ n-3	UShort [16b]	R		43555
V_INTERRUPTION_QUERY_N_3	Voltage Sag Type: 0: ND 1: V_L1N 2: V_L2N 3: V_L3N 4: V_L1L2 5: V_L2L3 6: V_L3L1	UShort [16b]	R		43556
V_INTERRUPTION_VALUE_N_4	Voltage Interruption RMS Value (between 10% and 90% "Nominal_Star_Voltage") @ n-4	Float [32b-LSW]	R		43557
V_INTERRUPTION_YEAR_N_4	Voltage Interruption Year @ n-4	UShort [16b]	R		43559
V_INTERRUPTION_MONTH_N_4	Voltage Interruption Month @ n-4	UShort [16b]	R		43560
V_INTERRUPTION_DAY_N_4	Voltage Interruption Day @ n-4	UShort [16b]	R		43561
V_INTERRUPTION_HOUR_N_4	Voltage Interruption Hour @ n-4	UShort [16b]	R		43562
V_INTERRUPTION_MINUTE_N_4	Voltage Interruption Minute @ n-4	UShort [16b]	R		43563
V_INTERRUPTION_SECONDS_N_4	Voltage Interruption Second @ n-4	UShort [16b]	R		43564
V_INTERRUPTION_DURATION_N_4	Voltage Interruption Duration [ms] @ n-4	UShort [16b]	R		43565
V_INTERRUPTION_QUERY_N_4	Voltage Sag Type: 0: ND 1: V_L1N 2: V_L2N 3: V_L3N 4: V_L1L2 5: V_L2L3 6: V_L3L1	UShort [16b]	R		43566
V_INTERRUPTION_VALUE_N_5	Voltage Interruption RMS Value (between 10% and 90% "Nominal_Star_Voltage") @ n-5	Float [32b-LSW]	R		43567
V_INTERRUPTION_YEAR_N_5	Voltage Interruption Year @ n-5	UShort [16b]	R		43569
V_INTERRUPTION_MONTH_N_5	Voltage Interruption Month @ n-5	UShort [16b]	R		43570
V_INTERRUPTION_DAY_N_5	Voltage Interruption Day @ n-5	UShort [16b]	R		43571
V_INTERRUPTION_HOUR_N_5	Voltage Interruption Hour @ n-5	UShort [16b]	R		43572
V_INTERRUPTION_MINUTE_N_5	Voltage Interruption Minute @ n-5	UShort [16b]	R		43573
V_INTERRUPTION_SECONDS_N_5	Voltage Interruption Second @ n-5	UShort [16b]	R		43574
V_INTERRUPTION_DURATION_N_5	Voltage Interruption Duration [ms] @ n-5	UShort [16b]	R		43575
V_INTERRUPTION_QUERY_N_5	Voltage Sag Type: 0: ND 1: V_L1N 2: V_L2N 3: V_L3N 4: V_L1L2 5: V_L2L3 6: V_L3L1	UShort [16b]	R		43576
V_INTERRUPTION_VALUE_N_6	Voltage Interruption RMS Value (between 10% and 90% "Nominal_Star_Voltage") @ n-6	Float [32b-LSW]	R		43577
V_INTERRUPTION_YEAR_N_6	Voltage Interruption Year @ n-6	UShort [16b]	R		43579
V_INTERRUPTION_MONTH_N_6	Voltage Interruption Month @ n-6	UShort [16b]	R		43580
V_INTERRUPTION_DAY_N_6	Voltage Interruption Day @ n-6	UShort [16b]	R		43581
V_INTERRUPTION_HOUR_N_6	Voltage Interruption Hour @ n-6	UShort [16b]	R		43582
V_INTERRUPTION_MINUTE_N_6	Voltage Interruption Minute @ n-6	UShort [16b]	R		43583
V_INTERRUPTION_SECONDS_N_6	Voltage Interruption Second @ n-6	UShort [16b]	R		43584
V_INTERRUPTION_DURATION_N_6	Voltage Interruption Duration [ms] @ n-6	UShort [16b]	R		43585



Register Name	Description	Register Type	R/W	Default	Address Modbus
V_INTERRUPTION_QUERY_N_6	Voltage Sag Type: 0: ND 1: V_L1N 2: V_L2N 3: V_L3N 4: V_L1L2 5: V_L2L3 6: V_L3L1	UShort [16b]	R		43586
V_INTERRUPTION_VALUE_N_7	Voltage Interruption RMS Value (between 10% and 90% "Nominal_Star_Voltage") @ n-7	Float [32b-LSW]	R		43587
V_INTERRUPTION_YEAR_N_7	Voltage Interruption Year @ n-7	UShort [16b]	R		43589
V_INTERRUPTION_MONTH_N_7	Voltage Interruption Month @ n-7	UShort [16b]	R		43590
V_INTERRUPTION_DAY_N_7	Voltage Interruption Day @ n-7	UShort [16b]	R		43591
V_INTERRUPTION_HOUR_N_7	Voltage Interruption Hour @ n-7	UShort [16b]	R		43592
V_INTERRUPTION_MINUTE_N_7	Voltage Interruption Minute @ n-7	UShort [16b]	R		43593
V_INTERRUPTION_SECONDS_N_7	Voltage Interruption Second @ n-7	UShort [16b]	R		43594
V_INTERRUPTION_DURATION_N_7	Voltage Interruption Duration [ms] @ n-7	UShort [16b]	R		43595
V_INTERRUPTION_QUERY_N_7	Voltage Sag Type: 0: ND 1: V_L1N 2: V_L2N 3: V_L3N 4: V_L1L2 5: V_L2L3 6: V_L3L1	UShort [16b]	R		43596
V_INTERRUPTION_VALUE_N_8	Voltage Interruption RMS Value (between 10% and 90% "Nominal_Star_Voltage") @ n-8	Float [32b-LSW]	R		43597
V_INTERRUPTION_YEAR_N_8	Voltage Interruption Year @ n-8	UShort [16b]	R		43599
V_INTERRUPTION_MONTH_N_8	Voltage Interruption Month @ n-8	UShort [16b]	R		43600
V_INTERRUPTION_DAY_N_8	Voltage Interruption Day @ n-8	UShort [16b]	R		43601
V_INTERRUPTION_HOUR_N_8	Voltage Interruption Hour @ n-8	UShort [16b]	R		43602
V_INTERRUPTION_MINUTE_N_8	Voltage Interruption Minute @ n-8	UShort [16b]	R		43603
V_INTERRUPTION_SECONDS_N_8	Voltage Interruption Second @ n-8	UShort [16b]	R		43604
V_INTERRUPTION_DURATION_N_8	Voltage Interruption Duration [ms] @ n-8	UShort [16b]	R		43605
V_INTERRUPTION_QUERY_N_8	Voltage Sag Type: 0: ND 1: V_L1N 2: V_L2N 3: V_L3N 4: V_L1L2 5: V_L2L3 6: V_L3L1	UShort [16b]	R		43606
V_INTERRUPTION_VALUE_N_9	Voltage Interruption RMS Value (between 10% and 90% "Nominal_Star_Voltage") @ n-9	Float [32b-LSW]	R		43607
V_INTERRUPTION_YEAR_N_9	Voltage Interruption Year @ n-9	UShort [16b]	R		43609
V_INTERRUPTION_MONTH_N_9	Voltage Interruption Month @ n-9	UShort [16b]	R		43610
V_INTERRUPTION_DAY_N_9	Voltage Interruption Day @ n-9	UShort [16b]	R		43611
V_INTERRUPTION_HOUR_N_9	Voltage Interruption Hour @ n-9	UShort [16b]	R		43612
V_INTERRUPTION_MINUTE_N_9	Voltage Interruption Minute @ n-9	UShort [16b]	R		43613
V_INTERRUPTION_SECONDS_N_9	Voltage Interruption Second @ n-9	UShort [16b]	R		43614
V_INTERRUPTION_DURATION_N_9	Voltage Interruption Duration [ms] @ n-9	UShort [16b]	R		43615
V_INTERRUPTION_QUERY_N_9	Voltage Sag Type: 0: ND 1: V_L1N 2: V_L2N 3: V_L3N 4: V_L1L2 5: V_L2L3 6: V_L3L1	UShort [16b]	R		43616
V_INTERRUPTION_VALUE_EEPROM	Voltage Interruption RMS Value (between 10% and 90% "Nominal_Star_Voltage") EEPROM data	Float [32b-LSW]	R		43617
V_INTERRUPTION_YEAR_EEPROM	Voltage Interruption Year EEPROM data	UShort [16b]	R		43619
V_INTERRUPTION_MONTH_EEPROM	Voltage Interruption Month EEPROM data	UShort [16b]	R		43620
V_INTERRUPTION_DAY_EEPROM	Voltage Interruption Day EEPROM data	UShort [16b]	R		43621
V_INTERRUPTION_HOUR_EEPROM	Voltage Interruption Hour EEPROM data	UShort [16b]	R		43622
V_INTERRUPTION_MINUTE_EEPROM	Voltage Interruption Minute EEPROM data	UShort [16b]	R		43623
V_INTERRUPTION_SECONDS_EEPROM	Voltage Interruption Second EEPROM data	UShort [16b]	R		43624



Register Name	Description	Register Type	R/W	Default	Address Modbus
V_INTERRUPTION_DURATION_EEPROM	Voltage Interruption Duration [ms] EEPROM data	UShort [16b]	R		43625
V_INTERRUPTION_QUERY_EEPROM	Voltage Sag Type: 0: ND 1: V_L1N 2: V_L2N 3: V_L3N 4: V_L1L2 5: V_L2L3 6: V_L3L1	UShort [16b]	R		43626
V_L1N_Oscilloscope_0	Star Voltage L1-N Sample #0	Float [32b-LSW]	R		43627
V_L1N_Oscilloscope_1	Star Voltage L1-N Sample #1	Float [32b-LSW]	R		43629
V_L1N_Oscilloscope_2	Star Voltage L1-N Sample #2	Float [32b-LSW]	R		43631
V_L1N_Oscilloscope_3	Star Voltage L1-N Sample #3	Float [32b-LSW]	R		43633
V_L1N_Oscilloscope_4	Star Voltage L1-N Sample #4	Float [32b-LSW]	R		43635
V_L1N_Oscilloscope_5	Star Voltage L1-N Sample #5	Float [32b-LSW]	R		43637
V_L1N_Oscilloscope_6	Star Voltage L1-N Sample #6	Float [32b-LSW]	R		43639
V_L1N_Oscilloscope_7	Star Voltage L1-N Sample #7	Float [32b-LSW]	R		43641
V_L1N_Oscilloscope_8	Star Voltage L1-N Sample #8	Float [32b-LSW]	R		43643
V_L1N_Oscilloscope_9	Star Voltage L1-N Sample #9	Float [32b-LSW]	R		43645
V_L1N_Oscilloscope_10	Star Voltage L1-N Sample #10	Float [32b-LSW]	R		43647
V_L1N_Oscilloscope_11	Star Voltage L1-N Sample #11	Float [32b-LSW]	R		43649
V_L1N_Oscilloscope_12	Star Voltage L1-N Sample #12	Float [32b-LSW]	R		43651
V_L1N_Oscilloscope_13	Star Voltage L1-N Sample #13	Float [32b-LSW]	R		43653
V_L1N_Oscilloscope_14	Star Voltage L1-N Sample #14	Float [32b-LSW]	R		43655
V_L1N_Oscilloscope_15	Star Voltage L1-N Sample #15	Float [32b-LSW]	R		43657
V_L1N_Oscilloscope_16	Star Voltage L1-N Sample #16	Float [32b-LSW]	R		43659
V_L1N_Oscilloscope_17	Star Voltage L1-N Sample #17	Float [32b-LSW]	R		43661
V_L1N_Oscilloscope_18	Star Voltage L1-N Sample #18	Float [32b-LSW]	R		43663
V_L1N_Oscilloscope_19	Star Voltage L1-N Sample #19	Float [32b-LSW]	R		43665
V_L1N_Oscilloscope_20	Star Voltage L1-N Sample #20	Float [32b-LSW]	R		43667
V_L1N_Oscilloscope_21	Star Voltage L1-N Sample #21	Float [32b-LSW]	R		43669
V_L1N_Oscilloscope_22	Star Voltage L1-N Sample #22	Float [32b-LSW]	R		43671
V_L1N_Oscilloscope_23	Star Voltage L1-N Sample #23	Float [32b-LSW]	R		43673
V_L1N_Oscilloscope_24	Star Voltage L1-N Sample #24	Float [32b-LSW]	R		43675
V_L1N_Oscilloscope_25	Star Voltage L1-N Sample #25	Float [32b-LSW]	R		43677
V_L1N_Oscilloscope_26	Star Voltage L1-N Sample #26	Float [32b-LSW]	R		43679
V_L1N_Oscilloscope_27	Star Voltage L1-N Sample #27	Float [32b-LSW]	R		43681
V_L1N_Oscilloscope_28	Star Voltage L1-N Sample #28	Float [32b-LSW]	R		43683
V_L1N_Oscilloscope_29	Star Voltage L1-N Sample #29	Float [32b-LSW]	R		43685
V_L1N_Oscilloscope_30	Star Voltage L1-N Sample #30	Float [32b-LSW]	R		43687
V_L1N_Oscilloscope_31	Star Voltage L1-N Sample #31	Float [32b-LSW]	R		43689
V_L1N_Oscilloscope_32	Star Voltage L1-N Sample #32	Float [32b-LSW]	R		43691
V_L1N_Oscilloscope_33	Star Voltage L1-N Sample #33	Float [32b-LSW]	R		43693
V_L1N_Oscilloscope_34	Star Voltage L1-N Sample #34	Float [32b-LSW]	R		43695
V_L1N_Oscilloscope_35	Star Voltage L1-N Sample #35	Float [32b-LSW]	R		43697
V_L1N_Oscilloscope_36	Star Voltage L1-N Sample #36	Float [32b-LSW]	R		43699
V_L1N_Oscilloscope_37	Star Voltage L1-N Sample #37	Float [32b-LSW]	R		43701
V_L1N_Oscilloscope_38	Star Voltage L1-N Sample #38	Float [32b-LSW]	R		43703
V_L1N_Oscilloscope_39	Star Voltage L1-N Sample #39	Float [32b-LSW]	R		43705
V_L1N_Oscilloscope_40	Star Voltage L1-N Sample #40	Float [32b-LSW]	R		43707
V_L1N_Oscilloscope_41	Star Voltage L1-N Sample #41	Float [32b-LSW]	R		43709
V_L1N_Oscilloscope_42	Star Voltage L1-N Sample #42	Float [32b-LSW]	R		43711
V_L1N_Oscilloscope_43	Star Voltage L1-N Sample #43	Float [32b-LSW]	R		43713
V_L1N_Oscilloscope_44	Star Voltage L1-N Sample #44	Float [32b-LSW]	R		43715
V_L1N_Oscilloscope_45	Star Voltage L1-N Sample #45	Float [32b-LSW]	R		43717
V_L1N_Oscilloscope_46	Star Voltage L1-N Sample #46	Float [32b-LSW]	R		43719
V_L1N_Oscilloscope_47	Star Voltage L1-N Sample #47	Float [32b-LSW]	R		43721
V_L1N_Oscilloscope_48	Star Voltage L1-N Sample #48	Float [32b-LSW]	R		43723
V_L1N_Oscilloscope_49	Star Voltage L1-N Sample #49	Float [32b-LSW]	R		43725
V_L1N_Oscilloscope_50	Star Voltage L1-N Sample #50	Float [32b-LSW]	R		43727
V_L1N_Oscilloscope_51	Star Voltage L1-N Sample #51	Float [32b-LSW]	R		43729
V_L1N_Oscilloscope_52	Star Voltage L1-N Sample #52	Float [32b-LSW]	R		43731
V_L1N_Oscilloscope_53	Star Voltage L1-N Sample #53	Float [32b-LSW]	R		43733



Register Name	Description	Register Type	R/W	Default	Address Modbus
V_L1N_Oscilloscope_54	Star Voltage L1-N Sample #54	Float [32b-LSW]	R		43735
V_L1N_Oscilloscope_55	Star Voltage L1-N Sample #55	Float [32b-LSW]	R		43737
V_L1N_Oscilloscope_56	Star Voltage L1-N Sample #56	Float [32b-LSW]	R		43739
V_L1N_Oscilloscope_57	Star Voltage L1-N Sample #57	Float [32b-LSW]	R		43741
V_L1N_Oscilloscope_58	Star Voltage L1-N Sample #58	Float [32b-LSW]	R		43743
V_L1N_Oscilloscope_59	Star Voltage L1-N Sample #59	Float [32b-LSW]	R		43745
V_L1N_Oscilloscope_60	Star Voltage L1-N Sample #60	Float [32b-LSW]	R		43747
V_L1N_Oscilloscope_61	Star Voltage L1-N Sample #61	Float [32b-LSW]	R		43749
V_L1N_Oscilloscope_62	Star Voltage L1-N Sample #62	Float [32b-LSW]	R		43751
V_L1N_Oscilloscope_63	Star Voltage L1-N Sample #63	Float [32b-LSW]	R		43753
V_L1N_Oscilloscope_64	Star Voltage L1-N Sample #64	Float [32b-LSW]	R		43755
V_L1N_Oscilloscope_65	Star Voltage L1-N Sample #65	Float [32b-LSW]	R		43757
V_L1N_Oscilloscope_66	Star Voltage L1-N Sample #66	Float [32b-LSW]	R		43759
V_L1N_Oscilloscope_67	Star Voltage L1-N Sample #67	Float [32b-LSW]	R		43761
V_L1N_Oscilloscope_68	Star Voltage L1-N Sample #68	Float [32b-LSW]	R		43763
V_L1N_Oscilloscope_69	Star Voltage L1-N Sample #69	Float [32b-LSW]	R		43765
V_L1N_Oscilloscope_70	Star Voltage L1-N Sample #70	Float [32b-LSW]	R		43767
V_L1N_Oscilloscope_71	Star Voltage L1-N Sample #71	Float [32b-LSW]	R		43769
V_L1N_Oscilloscope_72	Star Voltage L1-N Sample #72	Float [32b-LSW]	R		43771
V_L1N_Oscilloscope_73	Star Voltage L1-N Sample #73	Float [32b-LSW]	R		43773
V_L1N_Oscilloscope_74	Star Voltage L1-N Sample #74	Float [32b-LSW]	R		43775
V_L1N_Oscilloscope_75	Star Voltage L1-N Sample #75	Float [32b-LSW]	R		43777
V_L1N_Oscilloscope_76	Star Voltage L1-N Sample #76	Float [32b-LSW]	R		43779
V_L1N_Oscilloscope_77	Star Voltage L1-N Sample #77	Float [32b-LSW]	R		43781
V_L1N_Oscilloscope_78	Star Voltage L1-N Sample #78	Float [32b-LSW]	R		43783
V_L1N_Oscilloscope_79	Star Voltage L1-N Sample #79	Float [32b-LSW]	R		43785
V_L1N_Oscilloscope_80	Star Voltage L1-N Sample #80	Float [32b-LSW]	R		43787
V_L1N_Oscilloscope_81	Star Voltage L1-N Sample #81	Float [32b-LSW]	R		43789
V_L1N_Oscilloscope_82	Star Voltage L1-N Sample #82	Float [32b-LSW]	R		43791
V_L1N_Oscilloscope_83	Star Voltage L1-N Sample #83	Float [32b-LSW]	R		43793
V_L1N_Oscilloscope_84	Star Voltage L1-N Sample #84	Float [32b-LSW]	R		43795
V_L1N_Oscilloscope_85	Star Voltage L1-N Sample #85	Float [32b-LSW]	R		43797
V_L1N_Oscilloscope_86	Star Voltage L1-N Sample #86	Float [32b-LSW]	R		43799
V_L1N_Oscilloscope_87	Star Voltage L1-N Sample #87	Float [32b-LSW]	R		43801
V_L1N_Oscilloscope_88	Star Voltage L1-N Sample #88	Float [32b-LSW]	R		43803
V_L1N_Oscilloscope_89	Star Voltage L1-N Sample #89	Float [32b-LSW]	R		43805
V_L1N_Oscilloscope_90	Star Voltage L1-N Sample #90	Float [32b-LSW]	R		43807
V_L1N_Oscilloscope_91	Star Voltage L1-N Sample #91	Float [32b-LSW]	R		43809
V_L1N_Oscilloscope_92	Star Voltage L1-N Sample #92	Float [32b-LSW]	R		43811
V_L1N_Oscilloscope_93	Star Voltage L1-N Sample #93	Float [32b-LSW]	R		43813
V_L1N_Oscilloscope_94	Star Voltage L1-N Sample #94	Float [32b-LSW]	R		43815
V_L1N_Oscilloscope_95	Star Voltage L1-N Sample #95	Float [32b-LSW]	R		43817
V_L1N_Oscilloscope_96	Star Voltage L1-N Sample #96	Float [32b-LSW]	R		43819
V_L1N_Oscilloscope_97	Star Voltage L1-N Sample #97	Float [32b-LSW]	R		43821
V_L1N_Oscilloscope_98	Star Voltage L1-N Sample #98	Float [32b-LSW]	R		43823
V_L1N_Oscilloscope_99	Star Voltage L1-N Sample #99	Float [32b-LSW]	R		43825
V_L1N_Oscilloscope_100	Star Voltage L1-N Sample #100	Float [32b-LSW]	R		43827
V_L1N_Oscilloscope_101	Star Voltage L1-N Sample #101	Float [32b-LSW]	R		43829
V_L1N_Oscilloscope_102	Star Voltage L1-N Sample #102	Float [32b-LSW]	R		43831
V_L1N_Oscilloscope_103	Star Voltage L1-N Sample #103	Float [32b-LSW]	R		43833
V_L1N_Oscilloscope_104	Star Voltage L1-N Sample #104	Float [32b-LSW]	R		43835
V_L1N_Oscilloscope_105	Star Voltage L1-N Sample #105	Float [32b-LSW]	R		43837
V_L1N_Oscilloscope_106	Star Voltage L1-N Sample #106	Float [32b-LSW]	R		43839
V_L1N_Oscilloscope_107	Star Voltage L1-N Sample #107	Float [32b-LSW]	R		43841
V_L1N_Oscilloscope_108	Star Voltage L1-N Sample #108	Float [32b-LSW]	R		43843
V_L1N_Oscilloscope_109	Star Voltage L1-N Sample #109	Float [32b-LSW]	R		43845
V_L1N_Oscilloscope_110	Star Voltage L1-N Sample #110	Float [32b-LSW]	R		43847
V_L1N_Oscilloscope_111	Star Voltage L1-N Sample #111	Float [32b-LSW]	R		43849
V_L1N_Oscilloscope_112	Star Voltage L1-N Sample #112	Float [32b-LSW]	R		43851
V_L1N_Oscilloscope_113	Star Voltage L1-N Sample #113	Float [32b-LSW]	R		43853
V_L1N_Oscilloscope_114	Star Voltage L1-N Sample #114	Float [32b-LSW]	R		43855
V_L1N_Oscilloscope_115	Star Voltage L1-N Sample #115	Float [32b-LSW]	R		43857
V_L1N_Oscilloscope_116	Star Voltage L1-N Sample #116	Float [32b-LSW]	R		43859



Register Name	Description	Register Type	R/W	Default	Address Modbus
V_L1N_Oscilloscope_117	Star Voltage L1-N Sample #117	Float [32b-LSW]	R		43861
V_L1N_Oscilloscope_118	Star Voltage L1-N Sample #118	Float [32b-LSW]	R		43863
V_L1N_Oscilloscope_119	Star Voltage L1-N Sample #119	Float [32b-LSW]	R		43865
V_L1N_Oscilloscope_120	Star Voltage L1-N Sample #120	Float [32b-LSW]	R		43867
V_L1N_Oscilloscope_121	Star Voltage L1-N Sample #121	Float [32b-LSW]	R		43869
V_L1N_Oscilloscope_122	Star Voltage L1-N Sample #122	Float [32b-LSW]	R		43871
V_L1N_Oscilloscope_123	Star Voltage L1-N Sample #123	Float [32b-LSW]	R		43873
V_L1N_Oscilloscope_124	Star Voltage L1-N Sample #124	Float [32b-LSW]	R		43875
V_L1N_Oscilloscope_125	Star Voltage L1-N Sample #125	Float [32b-LSW]	R		43877
V_L1N_Oscilloscope_126	Star Voltage L1-N Sample #126	Float [32b-LSW]	R		43879
V_L1N_Oscilloscope_127	Star Voltage L1-N Sample #127	Float [32b-LSW]	R		43881
V_L2N_Oscilloscope_0	Star Voltage L2-N Sample #0	Float [32b-LSW]	R		43883
V_L2N_Oscilloscope_1	Star Voltage L2-N Sample #1	Float [32b-LSW]	R		43885
V_L2N_Oscilloscope_2	Star Voltage L2-N Sample #2	Float [32b-LSW]	R		43887
V_L2N_Oscilloscope_3	Star Voltage L2-N Sample #3	Float [32b-LSW]	R		43889
V_L2N_Oscilloscope_4	Star Voltage L2-N Sample #4	Float [32b-LSW]	R		43891
V_L2N_Oscilloscope_5	Star Voltage L2-N Sample #5	Float [32b-LSW]	R		43893
V_L2N_Oscilloscope_6	Star Voltage L2-N Sample #6	Float [32b-LSW]	R		43895
V_L2N_Oscilloscope_7	Star Voltage L2-N Sample #7	Float [32b-LSW]	R		43897
V_L2N_Oscilloscope_8	Star Voltage L2-N Sample #8	Float [32b-LSW]	R		43899
V_L2N_Oscilloscope_9	Star Voltage L2-N Sample #9	Float [32b-LSW]	R		43901
V_L2N_Oscilloscope_10	Star Voltage L2-N Sample #10	Float [32b-LSW]	R		43903
V_L2N_Oscilloscope_11	Star Voltage L2-N Sample #11	Float [32b-LSW]	R		43905
V_L2N_Oscilloscope_12	Star Voltage L2-N Sample #12	Float [32b-LSW]	R		43907
V_L2N_Oscilloscope_13	Star Voltage L2-N Sample #13	Float [32b-LSW]	R		43909
V_L2N_Oscilloscope_14	Star Voltage L2-N Sample #14	Float [32b-LSW]	R		43911
V_L2N_Oscilloscope_15	Star Voltage L2-N Sample #15	Float [32b-LSW]	R		43913
V_L2N_Oscilloscope_16	Star Voltage L2-N Sample #16	Float [32b-LSW]	R		43915
V_L2N_Oscilloscope_17	Star Voltage L2-N Sample #17	Float [32b-LSW]	R		43917
V_L2N_Oscilloscope_18	Star Voltage L2-N Sample #18	Float [32b-LSW]	R		43919
V_L2N_Oscilloscope_19	Star Voltage L2-N Sample #19	Float [32b-LSW]	R		43921
V_L2N_Oscilloscope_20	Star Voltage L2-N Sample #20	Float [32b-LSW]	R		43923
V_L2N_Oscilloscope_21	Star Voltage L2-N Sample #21	Float [32b-LSW]	R		43925
V_L2N_Oscilloscope_22	Star Voltage L2-N Sample #22	Float [32b-LSW]	R		43927
V_L2N_Oscilloscope_23	Star Voltage L2-N Sample #23	Float [32b-LSW]	R		43929
V_L2N_Oscilloscope_24	Star Voltage L2-N Sample #24	Float [32b-LSW]	R		43931
V_L2N_Oscilloscope_25	Star Voltage L2-N Sample #25	Float [32b-LSW]	R		43933
V_L2N_Oscilloscope_26	Star Voltage L2-N Sample #26	Float [32b-LSW]	R		43935
V_L2N_Oscilloscope_27	Star Voltage L2-N Sample #27	Float [32b-LSW]	R		43937
V_L2N_Oscilloscope_28	Star Voltage L2-N Sample #28	Float [32b-LSW]	R		43939
V_L2N_Oscilloscope_29	Star Voltage L2-N Sample #29	Float [32b-LSW]	R		43941
V_L2N_Oscilloscope_30	Star Voltage L2-N Sample #30	Float [32b-LSW]	R		43943
V_L2N_Oscilloscope_31	Star Voltage L2-N Sample #31	Float [32b-LSW]	R		43945
V_L2N_Oscilloscope_32	Star Voltage L2-N Sample #32	Float [32b-LSW]	R		43947
V_L2N_Oscilloscope_33	Star Voltage L2-N Sample #33	Float [32b-LSW]	R		43949
V_L2N_Oscilloscope_34	Star Voltage L2-N Sample #34	Float [32b-LSW]	R		43951
V_L2N_Oscilloscope_35	Star Voltage L2-N Sample #35	Float [32b-LSW]	R		43953
V_L2N_Oscilloscope_36	Star Voltage L2-N Sample #36	Float [32b-LSW]	R		43955
V_L2N_Oscilloscope_37	Star Voltage L2-N Sample #37	Float [32b-LSW]	R		43957
V_L2N_Oscilloscope_38	Star Voltage L2-N Sample #38	Float [32b-LSW]	R		43959
V_L2N_Oscilloscope_39	Star Voltage L2-N Sample #39	Float [32b-LSW]	R		43961
V_L2N_Oscilloscope_40	Star Voltage L2-N Sample #40	Float [32b-LSW]	R		43963
V_L2N_Oscilloscope_41	Star Voltage L2-N Sample #41	Float [32b-LSW]	R		43965
V_L2N_Oscilloscope_42	Star Voltage L2-N Sample #42	Float [32b-LSW]	R		43967
V_L2N_Oscilloscope_43	Star Voltage L2-N Sample #43	Float [32b-LSW]	R		43969
V_L2N_Oscilloscope_44	Star Voltage L2-N Sample #44	Float [32b-LSW]	R		43971
V_L2N_Oscilloscope_45	Star Voltage L2-N Sample #45	Float [32b-LSW]	R		43973
V_L2N_Oscilloscope_46	Star Voltage L2-N Sample #46	Float [32b-LSW]	R		43975
V_L2N_Oscilloscope_47	Star Voltage L2-N Sample #47	Float [32b-LSW]	R		43977
V_L2N_Oscilloscope_48	Star Voltage L2-N Sample #48	Float [32b-LSW]	R		43979
V_L2N_Oscilloscope_49	Star Voltage L2-N Sample #49	Float [32b-LSW]	R		43981
V_L2N_Oscilloscope_50	Star Voltage L2-N Sample #50	Float [32b-LSW]	R		43983
V_L2N_Oscilloscope_51	Star Voltage L2-N Sample #51	Float [32b-LSW]	R		43985



Register Name	Description	Register Type	R/W	Default	Address Modbus
V_L2N_Oscilloscope_52	Star Voltage L2-N Sample #52	Float [32b-LSW]	R		43987
V_L2N_Oscilloscope_53	Star Voltage L2-N Sample #53	Float [32b-LSW]	R		43989
V_L2N_Oscilloscope_54	Star Voltage L2-N Sample #54	Float [32b-LSW]	R		43991
V_L2N_Oscilloscope_55	Star Voltage L2-N Sample #55	Float [32b-LSW]	R		43993
V_L2N_Oscilloscope_56	Star Voltage L2-N Sample #56	Float [32b-LSW]	R		43995
V_L2N_Oscilloscope_57	Star Voltage L2-N Sample #57	Float [32b-LSW]	R		43997
V_L2N_Oscilloscope_58	Star Voltage L2-N Sample #58	Float [32b-LSW]	R		43999
V_L2N_Oscilloscope_59	Star Voltage L2-N Sample #59	Float [32b-LSW]	R		44001
V_L2N_Oscilloscope_60	Star Voltage L2-N Sample #60	Float [32b-LSW]	R		44003
V_L2N_Oscilloscope_61	Star Voltage L2-N Sample #61	Float [32b-LSW]	R		44005
V_L2N_Oscilloscope_62	Star Voltage L2-N Sample #62	Float [32b-LSW]	R		44007
V_L2N_Oscilloscope_63	Star Voltage L2-N Sample #63	Float [32b-LSW]	R		44009
V_L2N_Oscilloscope_64	Star Voltage L2-N Sample #64	Float [32b-LSW]	R		44011
V_L2N_Oscilloscope_65	Star Voltage L2-N Sample #65	Float [32b-LSW]	R		44013
V_L2N_Oscilloscope_66	Star Voltage L2-N Sample #66	Float [32b-LSW]	R		44015
V_L2N_Oscilloscope_67	Star Voltage L2-N Sample #67	Float [32b-LSW]	R		44017
V_L2N_Oscilloscope_68	Star Voltage L2-N Sample #68	Float [32b-LSW]	R		44019
V_L2N_Oscilloscope_69	Star Voltage L2-N Sample #69	Float [32b-LSW]	R		44021
V_L2N_Oscilloscope_70	Star Voltage L2-N Sample #70	Float [32b-LSW]	R		44023
V_L2N_Oscilloscope_71	Star Voltage L2-N Sample #71	Float [32b-LSW]	R		44025
V_L2N_Oscilloscope_72	Star Voltage L2-N Sample #72	Float [32b-LSW]	R		44027
V_L2N_Oscilloscope_73	Star Voltage L2-N Sample #73	Float [32b-LSW]	R		44029
V_L2N_Oscilloscope_74	Star Voltage L2-N Sample #74	Float [32b-LSW]	R		44031
V_L2N_Oscilloscope_75	Star Voltage L2-N Sample #75	Float [32b-LSW]	R		44033
V_L2N_Oscilloscope_76	Star Voltage L2-N Sample #76	Float [32b-LSW]	R		44035
V_L2N_Oscilloscope_77	Star Voltage L2-N Sample #77	Float [32b-LSW]	R		44037
V_L2N_Oscilloscope_78	Star Voltage L2-N Sample #78	Float [32b-LSW]	R		44039
V_L2N_Oscilloscope_79	Star Voltage L2-N Sample #79	Float [32b-LSW]	R		44041
V_L2N_Oscilloscope_80	Star Voltage L2-N Sample #80	Float [32b-LSW]	R		44043
V_L2N_Oscilloscope_81	Star Voltage L2-N Sample #81	Float [32b-LSW]	R		44045
V_L2N_Oscilloscope_82	Star Voltage L2-N Sample #82	Float [32b-LSW]	R		44047
V_L2N_Oscilloscope_83	Star Voltage L2-N Sample #83	Float [32b-LSW]	R		44049
V_L2N_Oscilloscope_84	Star Voltage L2-N Sample #84	Float [32b-LSW]	R		44051
V_L2N_Oscilloscope_85	Star Voltage L2-N Sample #85	Float [32b-LSW]	R		44053
V_L2N_Oscilloscope_86	Star Voltage L2-N Sample #86	Float [32b-LSW]	R		44055
V_L2N_Oscilloscope_87	Star Voltage L2-N Sample #87	Float [32b-LSW]	R		44057
V_L2N_Oscilloscope_88	Star Voltage L2-N Sample #88	Float [32b-LSW]	R		44059
V_L2N_Oscilloscope_89	Star Voltage L2-N Sample #89	Float [32b-LSW]	R		44061
V_L2N_Oscilloscope_90	Star Voltage L2-N Sample #90	Float [32b-LSW]	R		44063
V_L2N_Oscilloscope_91	Star Voltage L2-N Sample #91	Float [32b-LSW]	R		44065
V_L2N_Oscilloscope_92	Star Voltage L2-N Sample #92	Float [32b-LSW]	R		44067
V_L2N_Oscilloscope_93	Star Voltage L2-N Sample #93	Float [32b-LSW]	R		44069
V_L2N_Oscilloscope_94	Star Voltage L2-N Sample #94	Float [32b-LSW]	R		44071
V_L2N_Oscilloscope_95	Star Voltage L2-N Sample #95	Float [32b-LSW]	R		44073
V_L2N_Oscilloscope_96	Star Voltage L2-N Sample #96	Float [32b-LSW]	R		44075
V_L2N_Oscilloscope_97	Star Voltage L2-N Sample #97	Float [32b-LSW]	R		44077
V_L2N_Oscilloscope_98	Star Voltage L2-N Sample #98	Float [32b-LSW]	R		44079
V_L2N_Oscilloscope_99	Star Voltage L2-N Sample #99	Float [32b-LSW]	R		44081
V_L2N_Oscilloscope_100	Star Voltage L2-N Sample #100	Float [32b-LSW]	R		44083
V_L2N_Oscilloscope_101	Star Voltage L2-N Sample #101	Float [32b-LSW]	R		44085
V_L2N_Oscilloscope_102	Star Voltage L2-N Sample #102	Float [32b-LSW]	R		44087
V_L2N_Oscilloscope_103	Star Voltage L2-N Sample #103	Float [32b-LSW]	R		44089
V_L2N_Oscilloscope_104	Star Voltage L2-N Sample #104	Float [32b-LSW]	R		44091
V_L2N_Oscilloscope_105	Star Voltage L2-N Sample #105	Float [32b-LSW]	R		44093
V_L2N_Oscilloscope_106	Star Voltage L2-N Sample #106	Float [32b-LSW]	R		44095
V_L2N_Oscilloscope_107	Star Voltage L2-N Sample #107	Float [32b-LSW]	R		44097
V_L2N_Oscilloscope_108	Star Voltage L2-N Sample #108	Float [32b-LSW]	R		44099
V_L2N_Oscilloscope_109	Star Voltage L2-N Sample #109	Float [32b-LSW]	R		44101
V_L2N_Oscilloscope_110	Star Voltage L2-N Sample #110	Float [32b-LSW]	R		44103
V_L2N_Oscilloscope_111	Star Voltage L2-N Sample #111	Float [32b-LSW]	R		44105
V_L2N_Oscilloscope_112	Star Voltage L2-N Sample #112	Float [32b-LSW]	R		44107
V_L2N_Oscilloscope_113	Star Voltage L2-N Sample #113	Float [32b-LSW]	R		44109
V_L2N_Oscilloscope_114	Star Voltage L2-N Sample #114	Float [32b-LSW]	R		44111



Register Name	Description	Register Type	R/W	Default	Address Modbus
V_L2N_Oscilloscope_115	Star Voltage L2-N Sample #115	Float [32b-LSW]	R		44113
V_L2N_Oscilloscope_116	Star Voltage L2-N Sample #116	Float [32b-LSW]	R		44115
V_L2N_Oscilloscope_117	Star Voltage L2-N Sample #117	Float [32b-LSW]	R		44117
V_L2N_Oscilloscope_118	Star Voltage L2-N Sample #118	Float [32b-LSW]	R		44119
V_L2N_Oscilloscope_119	Star Voltage L2-N Sample #119	Float [32b-LSW]	R		44121
V_L2N_Oscilloscope_120	Star Voltage L2-N Sample #120	Float [32b-LSW]	R		44123
V_L2N_Oscilloscope_121	Star Voltage L2-N Sample #121	Float [32b-LSW]	R		44125
V_L2N_Oscilloscope_122	Star Voltage L2-N Sample #122	Float [32b-LSW]	R		44127
V_L2N_Oscilloscope_123	Star Voltage L2-N Sample #123	Float [32b-LSW]	R		44129
V_L2N_Oscilloscope_124	Star Voltage L2-N Sample #124	Float [32b-LSW]	R		44131
V_L2N_Oscilloscope_125	Star Voltage L2-N Sample #125	Float [32b-LSW]	R		44133
V_L2N_Oscilloscope_126	Star Voltage L2-N Sample #126	Float [32b-LSW]	R		44135
V_L2N_Oscilloscope_127	Star Voltage L2-N Sample #127	Float [32b-LSW]	R		44137
V_L3N_Oscilloscope_0	Star Voltage L3-N Sample #0	Float [32b-LSW]	R		44139
V_L3N_Oscilloscope_1	Star Voltage L3-N Sample #1	Float [32b-LSW]	R		44141
V_L3N_Oscilloscope_2	Star Voltage L3-N Sample #2	Float [32b-LSW]	R		44143
V_L3N_Oscilloscope_3	Star Voltage L3-N Sample #3	Float [32b-LSW]	R		44145
V_L3N_Oscilloscope_4	Star Voltage L3-N Sample #4	Float [32b-LSW]	R		44147
V_L3N_Oscilloscope_5	Star Voltage L3-N Sample #5	Float [32b-LSW]	R		44149
V_L3N_Oscilloscope_6	Star Voltage L3-N Sample #6	Float [32b-LSW]	R		44151
V_L3N_Oscilloscope_7	Star Voltage L3-N Sample #7	Float [32b-LSW]	R		44153
V_L3N_Oscilloscope_8	Star Voltage L3-N Sample #8	Float [32b-LSW]	R		44155
V_L3N_Oscilloscope_9	Star Voltage L3-N Sample #9	Float [32b-LSW]	R		44157
V_L3N_Oscilloscope_10	Star Voltage L3-N Sample #10	Float [32b-LSW]	R		44159
V_L3N_Oscilloscope_11	Star Voltage L3-N Sample #11	Float [32b-LSW]	R		44161
V_L3N_Oscilloscope_12	Star Voltage L3-N Sample #12	Float [32b-LSW]	R		44163
V_L3N_Oscilloscope_13	Star Voltage L3-N Sample #13	Float [32b-LSW]	R		44165
V_L3N_Oscilloscope_14	Star Voltage L3-N Sample #14	Float [32b-LSW]	R		44167
V_L3N_Oscilloscope_15	Star Voltage L3-N Sample #15	Float [32b-LSW]	R		44169
V_L3N_Oscilloscope_16	Star Voltage L3-N Sample #16	Float [32b-LSW]	R		44171
V_L3N_Oscilloscope_17	Star Voltage L3-N Sample #17	Float [32b-LSW]	R		44173
V_L3N_Oscilloscope_18	Star Voltage L3-N Sample #18	Float [32b-LSW]	R		44175
V_L3N_Oscilloscope_19	Star Voltage L3-N Sample #19	Float [32b-LSW]	R		44177
V_L3N_Oscilloscope_20	Star Voltage L3-N Sample #20	Float [32b-LSW]	R		44179
V_L3N_Oscilloscope_21	Star Voltage L3-N Sample #21	Float [32b-LSW]	R		44181
V_L3N_Oscilloscope_22	Star Voltage L3-N Sample #22	Float [32b-LSW]	R		44183
V_L3N_Oscilloscope_23	Star Voltage L3-N Sample #23	Float [32b-LSW]	R		44185
V_L3N_Oscilloscope_24	Star Voltage L3-N Sample #24	Float [32b-LSW]	R		44187
V_L3N_Oscilloscope_25	Star Voltage L3-N Sample #25	Float [32b-LSW]	R		44189
V_L3N_Oscilloscope_26	Star Voltage L3-N Sample #26	Float [32b-LSW]	R		44191
V_L3N_Oscilloscope_27	Star Voltage L3-N Sample #27	Float [32b-LSW]	R		44193
V_L3N_Oscilloscope_28	Star Voltage L3-N Sample #28	Float [32b-LSW]	R		44195
V_L3N_Oscilloscope_29	Star Voltage L3-N Sample #29	Float [32b-LSW]	R		44197
V_L3N_Oscilloscope_30	Star Voltage L3-N Sample #30	Float [32b-LSW]	R		44199
V_L3N_Oscilloscope_31	Star Voltage L3-N Sample #31	Float [32b-LSW]	R		44201
V_L3N_Oscilloscope_32	Star Voltage L3-N Sample #32	Float [32b-LSW]	R		44203
V_L3N_Oscilloscope_33	Star Voltage L3-N Sample #33	Float [32b-LSW]	R		44205
V_L3N_Oscilloscope_34	Star Voltage L3-N Sample #34	Float [32b-LSW]	R		44207
V_L3N_Oscilloscope_35	Star Voltage L3-N Sample #35	Float [32b-LSW]	R		44209
V_L3N_Oscilloscope_36	Star Voltage L3-N Sample #36	Float [32b-LSW]	R		44211
V_L3N_Oscilloscope_37	Star Voltage L3-N Sample #37	Float [32b-LSW]	R		44213
V_L3N_Oscilloscope_38	Star Voltage L3-N Sample #38	Float [32b-LSW]	R		44215
V_L3N_Oscilloscope_39	Star Voltage L3-N Sample #39	Float [32b-LSW]	R		44217
V_L3N_Oscilloscope_40	Star Voltage L3-N Sample #40	Float [32b-LSW]	R		44219
V_L3N_Oscilloscope_41	Star Voltage L3-N Sample #41	Float [32b-LSW]	R		44221
V_L3N_Oscilloscope_42	Star Voltage L3-N Sample #42	Float [32b-LSW]	R		44223
V_L3N_Oscilloscope_43	Star Voltage L3-N Sample #43	Float [32b-LSW]	R		44225
V_L3N_Oscilloscope_44	Star Voltage L3-N Sample #44	Float [32b-LSW]	R		44227
V_L3N_Oscilloscope_45	Star Voltage L3-N Sample #45	Float [32b-LSW]	R		44229
V_L3N_Oscilloscope_46	Star Voltage L3-N Sample #46	Float [32b-LSW]	R		44231
V_L3N_Oscilloscope_47	Star Voltage L3-N Sample #47	Float [32b-LSW]	R		44233
V_L3N_Oscilloscope_48	Star Voltage L3-N Sample #48	Float [32b-LSW]	R		44235
V_L3N_Oscilloscope_49	Star Voltage L3-N Sample #49	Float [32b-LSW]	R		44237



Register Name	Description	Register Type	R/W	Default	Address Modbus
V_L3N_Oscilloscope_50	Star Voltage L3-N Sample #50	Float [32b-LSW]	R		44239
V_L3N_Oscilloscope_51	Star Voltage L3-N Sample #51	Float [32b-LSW]	R		44241
V_L3N_Oscilloscope_52	Star Voltage L3-N Sample #52	Float [32b-LSW]	R		44243
V_L3N_Oscilloscope_53	Star Voltage L3-N Sample #53	Float [32b-LSW]	R		44245
V_L3N_Oscilloscope_54	Star Voltage L3-N Sample #54	Float [32b-LSW]	R		44247
V_L3N_Oscilloscope_55	Star Voltage L3-N Sample #55	Float [32b-LSW]	R		44249
V_L3N_Oscilloscope_56	Star Voltage L3-N Sample #56	Float [32b-LSW]	R		44251
V_L3N_Oscilloscope_57	Star Voltage L3-N Sample #57	Float [32b-LSW]	R		44253
V_L3N_Oscilloscope_58	Star Voltage L3-N Sample #58	Float [32b-LSW]	R		44255
V_L3N_Oscilloscope_59	Star Voltage L3-N Sample #59	Float [32b-LSW]	R		44257
V_L3N_Oscilloscope_60	Star Voltage L3-N Sample #60	Float [32b-LSW]	R		44259
V_L3N_Oscilloscope_61	Star Voltage L3-N Sample #61	Float [32b-LSW]	R		44261
V_L3N_Oscilloscope_62	Star Voltage L3-N Sample #62	Float [32b-LSW]	R		44263
V_L3N_Oscilloscope_63	Star Voltage L3-N Sample #63	Float [32b-LSW]	R		44265
V_L3N_Oscilloscope_64	Star Voltage L3-N Sample #64	Float [32b-LSW]	R		44267
V_L3N_Oscilloscope_65	Star Voltage L3-N Sample #65	Float [32b-LSW]	R		44269
V_L3N_Oscilloscope_66	Star Voltage L3-N Sample #66	Float [32b-LSW]	R		44271
V_L3N_Oscilloscope_67	Star Voltage L3-N Sample #67	Float [32b-LSW]	R		44273
V_L3N_Oscilloscope_68	Star Voltage L3-N Sample #68	Float [32b-LSW]	R		44275
V_L3N_Oscilloscope_69	Star Voltage L3-N Sample #69	Float [32b-LSW]	R		44277
V_L3N_Oscilloscope_70	Star Voltage L3-N Sample #70	Float [32b-LSW]	R		44279
V_L3N_Oscilloscope_71	Star Voltage L3-N Sample #71	Float [32b-LSW]	R		44281
V_L3N_Oscilloscope_72	Star Voltage L3-N Sample #72	Float [32b-LSW]	R		44283
V_L3N_Oscilloscope_73	Star Voltage L3-N Sample #73	Float [32b-LSW]	R		44285
V_L3N_Oscilloscope_74	Star Voltage L3-N Sample #74	Float [32b-LSW]	R		44287
V_L3N_Oscilloscope_75	Star Voltage L3-N Sample #75	Float [32b-LSW]	R		44289
V_L3N_Oscilloscope_76	Star Voltage L3-N Sample #76	Float [32b-LSW]	R		44291
V_L3N_Oscilloscope_77	Star Voltage L3-N Sample #77	Float [32b-LSW]	R		44293
V_L3N_Oscilloscope_78	Star Voltage L3-N Sample #78	Float [32b-LSW]	R		44295
V_L3N_Oscilloscope_79	Star Voltage L3-N Sample #79	Float [32b-LSW]	R		44297
V_L3N_Oscilloscope_80	Star Voltage L3-N Sample #80	Float [32b-LSW]	R		44299
V_L3N_Oscilloscope_81	Star Voltage L3-N Sample #81	Float [32b-LSW]	R		44301
V_L3N_Oscilloscope_82	Star Voltage L3-N Sample #82	Float [32b-LSW]	R		44303
V_L3N_Oscilloscope_83	Star Voltage L3-N Sample #83	Float [32b-LSW]	R		44305
V_L3N_Oscilloscope_84	Star Voltage L3-N Sample #84	Float [32b-LSW]	R		44307
V_L3N_Oscilloscope_85	Star Voltage L3-N Sample #85	Float [32b-LSW]	R		44309
V_L3N_Oscilloscope_86	Star Voltage L3-N Sample #86	Float [32b-LSW]	R		44311
V_L3N_Oscilloscope_87	Star Voltage L3-N Sample #87	Float [32b-LSW]	R		44313
V_L3N_Oscilloscope_88	Star Voltage L3-N Sample #88	Float [32b-LSW]	R		44315
V_L3N_Oscilloscope_89	Star Voltage L3-N Sample #89	Float [32b-LSW]	R		44317
V_L3N_Oscilloscope_90	Star Voltage L3-N Sample #90	Float [32b-LSW]	R		44319
V_L3N_Oscilloscope_91	Star Voltage L3-N Sample #91	Float [32b-LSW]	R		44321
V_L3N_Oscilloscope_92	Star Voltage L3-N Sample #92	Float [32b-LSW]	R		44323
V_L3N_Oscilloscope_93	Star Voltage L3-N Sample #93	Float [32b-LSW]	R		44325
V_L3N_Oscilloscope_94	Star Voltage L3-N Sample #94	Float [32b-LSW]	R		44327
V_L3N_Oscilloscope_95	Star Voltage L3-N Sample #95	Float [32b-LSW]	R		44329
V_L3N_Oscilloscope_96	Star Voltage L3-N Sample #96	Float [32b-LSW]	R		44331
V_L3N_Oscilloscope_97	Star Voltage L3-N Sample #97	Float [32b-LSW]	R		44333
V_L3N_Oscilloscope_98	Star Voltage L3-N Sample #98	Float [32b-LSW]	R		44335
V_L3N_Oscilloscope_99	Star Voltage L3-N Sample #99	Float [32b-LSW]	R		44337
V_L3N_Oscilloscope_100	Star Voltage L3-N Sample #100	Float [32b-LSW]	R		44339
V_L3N_Oscilloscope_101	Star Voltage L3-N Sample #101	Float [32b-LSW]	R		44341
V_L3N_Oscilloscope_102	Star Voltage L3-N Sample #102	Float [32b-LSW]	R		44343
V_L3N_Oscilloscope_103	Star Voltage L3-N Sample #103	Float [32b-LSW]	R		44345
V_L3N_Oscilloscope_104	Star Voltage L3-N Sample #104	Float [32b-LSW]	R		44347
V_L3N_Oscilloscope_105	Star Voltage L3-N Sample #105	Float [32b-LSW]	R		44349
V_L3N_Oscilloscope_106	Star Voltage L3-N Sample #106	Float [32b-LSW]	R		44351
V_L3N_Oscilloscope_107	Star Voltage L3-N Sample #107	Float [32b-LSW]	R		44353
V_L3N_Oscilloscope_108	Star Voltage L3-N Sample #108	Float [32b-LSW]	R		44355
V_L3N_Oscilloscope_109	Star Voltage L3-N Sample #109	Float [32b-LSW]	R		44357
V_L3N_Oscilloscope_110	Star Voltage L3-N Sample #110	Float [32b-LSW]	R		44359
V_L3N_Oscilloscope_111	Star Voltage L3-N Sample #111	Float [32b-LSW]	R		44361
V_L3N_Oscilloscope_112	Star Voltage L3-N Sample #112	Float [32b-LSW]	R		44363



Register Name	Description	Register Type	R/W	Default	Address Modbus
V_L3N_Oscilloscope_113	Star Voltage L3-N Sample #113	Float [32b-LSW]	R		44365
V_L3N_Oscilloscope_114	Star Voltage L3-N Sample #114	Float [32b-LSW]	R		44367
V_L3N_Oscilloscope_115	Star Voltage L3-N Sample #115	Float [32b-LSW]	R		44369
V_L3N_Oscilloscope_116	Star Voltage L3-N Sample #116	Float [32b-LSW]	R		44371
V_L3N_Oscilloscope_117	Star Voltage L3-N Sample #117	Float [32b-LSW]	R		44373
V_L3N_Oscilloscope_118	Star Voltage L3-N Sample #118	Float [32b-LSW]	R		44375
V_L3N_Oscilloscope_119	Star Voltage L3-N Sample #119	Float [32b-LSW]	R		44377
V_L3N_Oscilloscope_120	Star Voltage L3-N Sample #120	Float [32b-LSW]	R		44379
V_L3N_Oscilloscope_121	Star Voltage L3-N Sample #121	Float [32b-LSW]	R		44381
V_L3N_Oscilloscope_122	Star Voltage L3-N Sample #122	Float [32b-LSW]	R		44383
V_L3N_Oscilloscope_123	Star Voltage L3-N Sample #123	Float [32b-LSW]	R		44385
V_L3N_Oscilloscope_124	Star Voltage L3-N Sample #124	Float [32b-LSW]	R		44387
V_L3N_Oscilloscope_125	Star Voltage L3-N Sample #125	Float [32b-LSW]	R		44389
V_L3N_Oscilloscope_126	Star Voltage L3-N Sample #126	Float [32b-LSW]	R		44391
V_L3N_Oscilloscope_127	Star Voltage L3-N Sample #127	Float [32b-LSW]	R		44393
V_L12_Oscilloscope_0	Line Voltage L1-L2 Sample #0	Float [32b-LSW]	R		44395
V_L12_Oscilloscope_1	Line Voltage L1-L2 Sample #1	Float [32b-LSW]	R		44397
V_L12_Oscilloscope_2	Line Voltage L1-L2 Sample #2	Float [32b-LSW]	R		44399
V_L12_Oscilloscope_3	Line Voltage L1-L2 Sample #3	Float [32b-LSW]	R		44401
V_L12_Oscilloscope_4	Line Voltage L1-L2 Sample #4	Float [32b-LSW]	R		44403
V_L12_Oscilloscope_5	Line Voltage L1-L2 Sample #5	Float [32b-LSW]	R		44405
V_L12_Oscilloscope_6	Line Voltage L1-L2 Sample #6	Float [32b-LSW]	R		44407
V_L12_Oscilloscope_7	Line Voltage L1-L2 Sample #7	Float [32b-LSW]	R		44409
V_L12_Oscilloscope_8	Line Voltage L1-L2 Sample #8	Float [32b-LSW]	R		44411
V_L12_Oscilloscope_9	Line Voltage L1-L2 Sample #9	Float [32b-LSW]	R		44413
V_L12_Oscilloscope_10	Line Voltage L1-L2 Sample #10	Float [32b-LSW]	R		44415
V_L12_Oscilloscope_11	Line Voltage L1-L2 Sample #11	Float [32b-LSW]	R		44417
V_L12_Oscilloscope_12	Line Voltage L1-L2 Sample #12	Float [32b-LSW]	R		44419
V_L12_Oscilloscope_13	Line Voltage L1-L2 Sample #13	Float [32b-LSW]	R		44421
V_L12_Oscilloscope_14	Line Voltage L1-L2 Sample #14	Float [32b-LSW]	R		44423
V_L12_Oscilloscope_15	Line Voltage L1-L2 Sample #15	Float [32b-LSW]	R		44425
V_L12_Oscilloscope_16	Line Voltage L1-L2 Sample #16	Float [32b-LSW]	R		44427
V_L12_Oscilloscope_17	Line Voltage L1-L2 Sample #17	Float [32b-LSW]	R		44429
V_L12_Oscilloscope_18	Line Voltage L1-L2 Sample #18	Float [32b-LSW]	R		44431
V_L12_Oscilloscope_19	Line Voltage L1-L2 Sample #19	Float [32b-LSW]	R		44433
V_L12_Oscilloscope_20	Line Voltage L1-L2 Sample #20	Float [32b-LSW]	R		44435
V_L12_Oscilloscope_21	Line Voltage L1-L2 Sample #21	Float [32b-LSW]	R		44437
V_L12_Oscilloscope_22	Line Voltage L1-L2 Sample #22	Float [32b-LSW]	R		44439
V_L12_Oscilloscope_23	Line Voltage L1-L2 Sample #23	Float [32b-LSW]	R		44441
V_L12_Oscilloscope_24	Line Voltage L1-L2 Sample #24	Float [32b-LSW]	R		44443
V_L12_Oscilloscope_25	Line Voltage L1-L2 Sample #25	Float [32b-LSW]	R		44445
V_L12_Oscilloscope_26	Line Voltage L1-L2 Sample #26	Float [32b-LSW]	R		44447
V_L12_Oscilloscope_27	Line Voltage L1-L2 Sample #27	Float [32b-LSW]	R		44449
V_L12_Oscilloscope_28	Line Voltage L1-L2 Sample #28	Float [32b-LSW]	R		44451
V_L12_Oscilloscope_29	Line Voltage L1-L2 Sample #29	Float [32b-LSW]	R		44453
V_L12_Oscilloscope_30	Line Voltage L1-L2 Sample #30	Float [32b-LSW]	R		44455
V_L12_Oscilloscope_31	Line Voltage L1-L2 Sample #31	Float [32b-LSW]	R		44457
V_L12_Oscilloscope_32	Line Voltage L1-L2 Sample #32	Float [32b-LSW]	R		44459
V_L12_Oscilloscope_33	Line Voltage L1-L2 Sample #33	Float [32b-LSW]	R		44461
V_L12_Oscilloscope_34	Line Voltage L1-L2 Sample #34	Float [32b-LSW]	R		44463
V_L12_Oscilloscope_35	Line Voltage L1-L2 Sample #35	Float [32b-LSW]	R		44465
V_L12_Oscilloscope_36	Line Voltage L1-L2 Sample #36	Float [32b-LSW]	R		44467
V_L12_Oscilloscope_37	Line Voltage L1-L2 Sample #37	Float [32b-LSW]	R		44469
V_L12_Oscilloscope_38	Line Voltage L1-L2 Sample #38	Float [32b-LSW]	R		44471
V_L12_Oscilloscope_39	Line Voltage L1-L2 Sample #39	Float [32b-LSW]	R		44473
V_L12_Oscilloscope_40	Line Voltage L1-L2 Sample #40	Float [32b-LSW]	R		44475
V_L12_Oscilloscope_41	Line Voltage L1-L2 Sample #41	Float [32b-LSW]	R		44477
V_L12_Oscilloscope_42	Line Voltage L1-L2 Sample #42	Float [32b-LSW]	R		44479
V_L12_Oscilloscope_43	Line Voltage L1-L2 Sample #43	Float [32b-LSW]	R		44481
V_L12_Oscilloscope_44	Line Voltage L1-L2 Sample #44	Float [32b-LSW]	R		44483
V_L12_Oscilloscope_45	Line Voltage L1-L2 Sample #45	Float [32b-LSW]	R		44485
V_L12_Oscilloscope_46	Line Voltage L1-L2 Sample #46	Float [32b-LSW]	R		44487
V_L12_Oscilloscope_47	Line Voltage L1-L2 Sample #47	Float [32b-LSW]	R		44489



Register Name	Description	Register Type	R/W	Default	Address Modbus
V_L12_Oscilloscope_48	Line Voltage L1-L2 Sample #48	Float [32b-LSW]	R		44491
V_L12_Oscilloscope_49	Line Voltage L1-L2 Sample #49	Float [32b-LSW]	R		44493
V_L12_Oscilloscope_50	Line Voltage L1-L2 Sample #50	Float [32b-LSW]	R		44495
V_L12_Oscilloscope_51	Line Voltage L1-L2 Sample #51	Float [32b-LSW]	R		44497
V_L12_Oscilloscope_52	Line Voltage L1-L2 Sample #52	Float [32b-LSW]	R		44499
V_L12_Oscilloscope_53	Line Voltage L1-L2 Sample #53	Float [32b-LSW]	R		44501
V_L12_Oscilloscope_54	Line Voltage L1-L2 Sample #54	Float [32b-LSW]	R		44503
V_L12_Oscilloscope_55	Line Voltage L1-L2 Sample #55	Float [32b-LSW]	R		44505
V_L12_Oscilloscope_56	Line Voltage L1-L2 Sample #56	Float [32b-LSW]	R		44507
V_L12_Oscilloscope_57	Line Voltage L1-L2 Sample #57	Float [32b-LSW]	R		44509
V_L12_Oscilloscope_58	Line Voltage L1-L2 Sample #58	Float [32b-LSW]	R		44511
V_L12_Oscilloscope_59	Line Voltage L1-L2 Sample #59	Float [32b-LSW]	R		44513
V_L12_Oscilloscope_60	Line Voltage L1-L2 Sample #60	Float [32b-LSW]	R		44515
V_L12_Oscilloscope_61	Line Voltage L1-L2 Sample #61	Float [32b-LSW]	R		44517
V_L12_Oscilloscope_62	Line Voltage L1-L2 Sample #62	Float [32b-LSW]	R		44519
V_L12_Oscilloscope_63	Line Voltage L1-L2 Sample #63	Float [32b-LSW]	R		44521
V_L12_Oscilloscope_64	Line Voltage L1-L2 Sample #64	Float [32b-LSW]	R		44523
V_L12_Oscilloscope_65	Line Voltage L1-L2 Sample #65	Float [32b-LSW]	R		44525
V_L12_Oscilloscope_66	Line Voltage L1-L2 Sample #66	Float [32b-LSW]	R		44527
V_L12_Oscilloscope_67	Line Voltage L1-L2 Sample #67	Float [32b-LSW]	R		44529
V_L12_Oscilloscope_68	Line Voltage L1-L2 Sample #68	Float [32b-LSW]	R		44531
V_L12_Oscilloscope_69	Line Voltage L1-L2 Sample #69	Float [32b-LSW]	R		44533
V_L12_Oscilloscope_70	Line Voltage L1-L2 Sample #70	Float [32b-LSW]	R		44535
V_L12_Oscilloscope_71	Line Voltage L1-L2 Sample #71	Float [32b-LSW]	R		44537
V_L12_Oscilloscope_72	Line Voltage L1-L2 Sample #72	Float [32b-LSW]	R		44539
V_L12_Oscilloscope_73	Line Voltage L1-L2 Sample #73	Float [32b-LSW]	R		44541
V_L12_Oscilloscope_74	Line Voltage L1-L2 Sample #74	Float [32b-LSW]	R		44543
V_L12_Oscilloscope_75	Line Voltage L1-L2 Sample #75	Float [32b-LSW]	R		44545
V_L12_Oscilloscope_76	Line Voltage L1-L2 Sample #76	Float [32b-LSW]	R		44547
V_L12_Oscilloscope_77	Line Voltage L1-L2 Sample #77	Float [32b-LSW]	R		44549
V_L12_Oscilloscope_78	Line Voltage L1-L2 Sample #78	Float [32b-LSW]	R		44551
V_L12_Oscilloscope_79	Line Voltage L1-L2 Sample #79	Float [32b-LSW]	R		44553
V_L12_Oscilloscope_80	Line Voltage L1-L2 Sample #80	Float [32b-LSW]	R		44555
V_L12_Oscilloscope_81	Line Voltage L1-L2 Sample #81	Float [32b-LSW]	R		44557
V_L12_Oscilloscope_82	Line Voltage L1-L2 Sample #82	Float [32b-LSW]	R		44559
V_L12_Oscilloscope_83	Line Voltage L1-L2 Sample #83	Float [32b-LSW]	R		44561
V_L12_Oscilloscope_84	Line Voltage L1-L2 Sample #84	Float [32b-LSW]	R		44563
V_L12_Oscilloscope_85	Line Voltage L1-L2 Sample #85	Float [32b-LSW]	R		44565
V_L12_Oscilloscope_86	Line Voltage L1-L2 Sample #86	Float [32b-LSW]	R		44567
V_L12_Oscilloscope_87	Line Voltage L1-L2 Sample #87	Float [32b-LSW]	R		44569
V_L12_Oscilloscope_88	Line Voltage L1-L2 Sample #88	Float [32b-LSW]	R		44571
V_L12_Oscilloscope_89	Line Voltage L1-L2 Sample #89	Float [32b-LSW]	R		44573
V_L12_Oscilloscope_90	Line Voltage L1-L2 Sample #90	Float [32b-LSW]	R		44575
V_L12_Oscilloscope_91	Line Voltage L1-L2 Sample #91	Float [32b-LSW]	R		44577
V_L12_Oscilloscope_92	Line Voltage L1-L2 Sample #92	Float [32b-LSW]	R		44579
V_L12_Oscilloscope_93	Line Voltage L1-L2 Sample #93	Float [32b-LSW]	R		44581
V_L12_Oscilloscope_94	Line Voltage L1-L2 Sample #94	Float [32b-LSW]	R		44583
V_L12_Oscilloscope_95	Line Voltage L1-L2 Sample #95	Float [32b-LSW]	R		44585
V_L12_Oscilloscope_96	Line Voltage L1-L2 Sample #96	Float [32b-LSW]	R		44587
V_L12_Oscilloscope_97	Line Voltage L1-L2 Sample #97	Float [32b-LSW]	R		44589
V_L12_Oscilloscope_98	Line Voltage L1-L2 Sample #98	Float [32b-LSW]	R		44591
V_L12_Oscilloscope_99	Line Voltage L1-L2 Sample #99	Float [32b-LSW]	R		44593
V_L12_Oscilloscope_100	Line Voltage L1-L2 Sample #100	Float [32b-LSW]	R		44595
V_L12_Oscilloscope_101	Line Voltage L1-L2 Sample #101	Float [32b-LSW]	R		44597
V_L12_Oscilloscope_102	Line Voltage L1-L2 Sample #102	Float [32b-LSW]	R		44599
V_L12_Oscilloscope_103	Line Voltage L1-L2 Sample #103	Float [32b-LSW]	R		44601
V_L12_Oscilloscope_104	Line Voltage L1-L2 Sample #104	Float [32b-LSW]	R		44603
V_L12_Oscilloscope_105	Line Voltage L1-L2 Sample #105	Float [32b-LSW]	R		44605
V_L12_Oscilloscope_106	Line Voltage L1-L2 Sample #106	Float [32b-LSW]	R		44607
V_L12_Oscilloscope_107	Line Voltage L1-L2 Sample #107	Float [32b-LSW]	R		44609
V_L12_Oscilloscope_108	Line Voltage L1-L2 Sample #108	Float [32b-LSW]	R		44611
V_L12_Oscilloscope_109	Line Voltage L1-L2 Sample #109	Float [32b-LSW]	R		44613
V_L12_Oscilloscope_110	Line Voltage L1-L2 Sample #110	Float [32b-LSW]	R		44615



Register Name	Description	Register Type	R/W	Default	Address Modbus
V_L12_Oscilloscope_111	Line Voltage L1-L2 Sample #111	Float [32b-LSW]	R		44617
V_L12_Oscilloscope_112	Line Voltage L1-L2 Sample #112	Float [32b-LSW]	R		44619
V_L12_Oscilloscope_113	Line Voltage L1-L2 Sample #113	Float [32b-LSW]	R		44621
V_L12_Oscilloscope_114	Line Voltage L1-L2 Sample #114	Float [32b-LSW]	R		44623
V_L12_Oscilloscope_115	Line Voltage L1-L2 Sample #115	Float [32b-LSW]	R		44625
V_L12_Oscilloscope_116	Line Voltage L1-L2 Sample #116	Float [32b-LSW]	R		44627
V_L12_Oscilloscope_117	Line Voltage L1-L2 Sample #117	Float [32b-LSW]	R		44629
V_L12_Oscilloscope_118	Line Voltage L1-L2 Sample #118	Float [32b-LSW]	R		44631
V_L12_Oscilloscope_119	Line Voltage L1-L2 Sample #119	Float [32b-LSW]	R		44633
V_L12_Oscilloscope_120	Line Voltage L1-L2 Sample #120	Float [32b-LSW]	R		44635
V_L12_Oscilloscope_121	Line Voltage L1-L2 Sample #121	Float [32b-LSW]	R		44637
V_L12_Oscilloscope_122	Line Voltage L1-L2 Sample #122	Float [32b-LSW]	R		44639
V_L12_Oscilloscope_123	Line Voltage L1-L2 Sample #123	Float [32b-LSW]	R		44641
V_L12_Oscilloscope_124	Line Voltage L1-L2 Sample #124	Float [32b-LSW]	R		44643
V_L12_Oscilloscope_125	Line Voltage L1-L2 Sample #125	Float [32b-LSW]	R		44645
V_L12_Oscilloscope_126	Line Voltage L1-L2 Sample #126	Float [32b-LSW]	R		44647
V_L12_Oscilloscope_127	Line Voltage L1-L2 Sample #127	Float [32b-LSW]	R		44649
V_L23_Oscilloscope_0	Line Voltage L2-L3 Sample #0	Float [32b-LSW]	R		44651
V_L23_Oscilloscope_1	Line Voltage L2-L3 Sample #1	Float [32b-LSW]	R		44653
V_L23_Oscilloscope_2	Line Voltage L2-L3 Sample #2	Float [32b-LSW]	R		44655
V_L23_Oscilloscope_3	Line Voltage L2-L3 Sample #3	Float [32b-LSW]	R		44657
V_L23_Oscilloscope_4	Line Voltage L2-L3 Sample #4	Float [32b-LSW]	R		44659
V_L23_Oscilloscope_5	Line Voltage L2-L3 Sample #5	Float [32b-LSW]	R		44661
V_L23_Oscilloscope_6	Line Voltage L2-L3 Sample #6	Float [32b-LSW]	R		44663
V_L23_Oscilloscope_7	Line Voltage L2-L3 Sample #7	Float [32b-LSW]	R		44665
V_L23_Oscilloscope_8	Line Voltage L2-L3 Sample #8	Float [32b-LSW]	R		44667
V_L23_Oscilloscope_9	Line Voltage L2-L3 Sample #9	Float [32b-LSW]	R		44669
V_L23_Oscilloscope_10	Line Voltage L2-L3 Sample #10	Float [32b-LSW]	R		44671
V_L23_Oscilloscope_11	Line Voltage L2-L3 Sample #11	Float [32b-LSW]	R		44673
V_L23_Oscilloscope_12	Line Voltage L2-L3 Sample #12	Float [32b-LSW]	R		44675
V_L23_Oscilloscope_13	Line Voltage L2-L3 Sample #13	Float [32b-LSW]	R		44677
V_L23_Oscilloscope_14	Line Voltage L2-L3 Sample #14	Float [32b-LSW]	R		44679
V_L23_Oscilloscope_15	Line Voltage L2-L3 Sample #15	Float [32b-LSW]	R		44681
V_L23_Oscilloscope_16	Line Voltage L2-L3 Sample #16	Float [32b-LSW]	R		44683
V_L23_Oscilloscope_17	Line Voltage L2-L3 Sample #17	Float [32b-LSW]	R		44685
V_L23_Oscilloscope_18	Line Voltage L2-L3 Sample #18	Float [32b-LSW]	R		44687
V_L23_Oscilloscope_19	Line Voltage L2-L3 Sample #19	Float [32b-LSW]	R		44689
V_L23_Oscilloscope_20	Line Voltage L2-L3 Sample #20	Float [32b-LSW]	R		44691
V_L23_Oscilloscope_21	Line Voltage L2-L3 Sample #21	Float [32b-LSW]	R		44693
V_L23_Oscilloscope_22	Line Voltage L2-L3 Sample #22	Float [32b-LSW]	R		44695
V_L23_Oscilloscope_23	Line Voltage L2-L3 Sample #23	Float [32b-LSW]	R		44697
V_L23_Oscilloscope_24	Line Voltage L2-L3 Sample #24	Float [32b-LSW]	R		44699
V_L23_Oscilloscope_25	Line Voltage L2-L3 Sample #25	Float [32b-LSW]	R		44701
V_L23_Oscilloscope_26	Line Voltage L2-L3 Sample #26	Float [32b-LSW]	R		44703
V_L23_Oscilloscope_27	Line Voltage L2-L3 Sample #27	Float [32b-LSW]	R		44705
V_L23_Oscilloscope_28	Line Voltage L2-L3 Sample #28	Float [32b-LSW]	R		44707
V_L23_Oscilloscope_29	Line Voltage L2-L3 Sample #29	Float [32b-LSW]	R		44709
V_L23_Oscilloscope_30	Line Voltage L2-L3 Sample #30	Float [32b-LSW]	R		44711
V_L23_Oscilloscope_31	Line Voltage L2-L3 Sample #31	Float [32b-LSW]	R		44713
V_L23_Oscilloscope_32	Line Voltage L2-L3 Sample #32	Float [32b-LSW]	R		44715
V_L23_Oscilloscope_33	Line Voltage L2-L3 Sample #33	Float [32b-LSW]	R		44717
V_L23_Oscilloscope_34	Line Voltage L2-L3 Sample #34	Float [32b-LSW]	R		44719
V_L23_Oscilloscope_35	Line Voltage L2-L3 Sample #35	Float [32b-LSW]	R		44721
V_L23_Oscilloscope_36	Line Voltage L2-L3 Sample #36	Float [32b-LSW]	R		44723
V_L23_Oscilloscope_37	Line Voltage L2-L3 Sample #37	Float [32b-LSW]	R		44725
V_L23_Oscilloscope_38	Line Voltage L2-L3 Sample #38	Float [32b-LSW]	R		44727
V_L23_Oscilloscope_39	Line Voltage L2-L3 Sample #39	Float [32b-LSW]	R		44729
V_L23_Oscilloscope_40	Line Voltage L2-L3 Sample #40	Float [32b-LSW]	R		44731
V_L23_Oscilloscope_41	Line Voltage L2-L3 Sample #41	Float [32b-LSW]	R		44733
V_L23_Oscilloscope_42	Line Voltage L2-L3 Sample #42	Float [32b-LSW]	R		44735
V_L23_Oscilloscope_43	Line Voltage L2-L3 Sample #43	Float [32b-LSW]	R		44737
V_L23_Oscilloscope_44	Line Voltage L2-L3 Sample #44	Float [32b-LSW]	R		44739
V_L23_Oscilloscope_45	Line Voltage L2-L3 Sample #45	Float [32b-LSW]	R		44741



Register Name	Description	Register Type	R/W	Default	Address Modbus
V_L23_Oscilloscope_46	Line Voltage L2-L3 Sample #46	Float [32b-LSW]	R		44743
V_L23_Oscilloscope_47	Line Voltage L2-L3 Sample #47	Float [32b-LSW]	R		44745
V_L23_Oscilloscope_48	Line Voltage L2-L3 Sample #48	Float [32b-LSW]	R		44747
V_L23_Oscilloscope_49	Line Voltage L2-L3 Sample #49	Float [32b-LSW]	R		44749
V_L23_Oscilloscope_50	Line Voltage L2-L3 Sample #50	Float [32b-LSW]	R		44751
V_L23_Oscilloscope_51	Line Voltage L2-L3 Sample #51	Float [32b-LSW]	R		44753
V_L23_Oscilloscope_52	Line Voltage L2-L3 Sample #52	Float [32b-LSW]	R		44755
V_L23_Oscilloscope_53	Line Voltage L2-L3 Sample #53	Float [32b-LSW]	R		44757
V_L23_Oscilloscope_54	Line Voltage L2-L3 Sample #54	Float [32b-LSW]	R		44759
V_L23_Oscilloscope_55	Line Voltage L2-L3 Sample #55	Float [32b-LSW]	R		44761
V_L23_Oscilloscope_56	Line Voltage L2-L3 Sample #56	Float [32b-LSW]	R		44763
V_L23_Oscilloscope_57	Line Voltage L2-L3 Sample #57	Float [32b-LSW]	R		44765
V_L23_Oscilloscope_58	Line Voltage L2-L3 Sample #58	Float [32b-LSW]	R		44767
V_L23_Oscilloscope_59	Line Voltage L2-L3 Sample #59	Float [32b-LSW]	R		44769
V_L23_Oscilloscope_60	Line Voltage L2-L3 Sample #60	Float [32b-LSW]	R		44771
V_L23_Oscilloscope_61	Line Voltage L2-L3 Sample #61	Float [32b-LSW]	R		44773
V_L23_Oscilloscope_62	Line Voltage L2-L3 Sample #62	Float [32b-LSW]	R		44775
V_L23_Oscilloscope_63	Line Voltage L2-L3 Sample #63	Float [32b-LSW]	R		44777
V_L23_Oscilloscope_64	Line Voltage L2-L3 Sample #64	Float [32b-LSW]	R		44779
V_L23_Oscilloscope_65	Line Voltage L2-L3 Sample #65	Float [32b-LSW]	R		44781
V_L23_Oscilloscope_66	Line Voltage L2-L3 Sample #66	Float [32b-LSW]	R		44783
V_L23_Oscilloscope_67	Line Voltage L2-L3 Sample #67	Float [32b-LSW]	R		44785
V_L23_Oscilloscope_68	Line Voltage L2-L3 Sample #68	Float [32b-LSW]	R		44787
V_L23_Oscilloscope_69	Line Voltage L2-L3 Sample #69	Float [32b-LSW]	R		44789
V_L23_Oscilloscope_70	Line Voltage L2-L3 Sample #70	Float [32b-LSW]	R		44791
V_L23_Oscilloscope_71	Line Voltage L2-L3 Sample #71	Float [32b-LSW]	R		44793
V_L23_Oscilloscope_72	Line Voltage L2-L3 Sample #72	Float [32b-LSW]	R		44795
V_L23_Oscilloscope_73	Line Voltage L2-L3 Sample #73	Float [32b-LSW]	R		44797
V_L23_Oscilloscope_74	Line Voltage L2-L3 Sample #74	Float [32b-LSW]	R		44799
V_L23_Oscilloscope_75	Line Voltage L2-L3 Sample #75	Float [32b-LSW]	R		44801
V_L23_Oscilloscope_76	Line Voltage L2-L3 Sample #76	Float [32b-LSW]	R		44803
V_L23_Oscilloscope_77	Line Voltage L2-L3 Sample #77	Float [32b-LSW]	R		44805
V_L23_Oscilloscope_78	Line Voltage L2-L3 Sample #78	Float [32b-LSW]	R		44807
V_L23_Oscilloscope_79	Line Voltage L2-L3 Sample #79	Float [32b-LSW]	R		44809
V_L23_Oscilloscope_80	Line Voltage L2-L3 Sample #80	Float [32b-LSW]	R		44811
V_L23_Oscilloscope_81	Line Voltage L2-L3 Sample #81	Float [32b-LSW]	R		44813
V_L23_Oscilloscope_82	Line Voltage L2-L3 Sample #82	Float [32b-LSW]	R		44815
V_L23_Oscilloscope_83	Line Voltage L2-L3 Sample #83	Float [32b-LSW]	R		44817
V_L23_Oscilloscope_84	Line Voltage L2-L3 Sample #84	Float [32b-LSW]	R		44819
V_L23_Oscilloscope_85	Line Voltage L2-L3 Sample #85	Float [32b-LSW]	R		44821
V_L23_Oscilloscope_86	Line Voltage L2-L3 Sample #86	Float [32b-LSW]	R		44823
V_L23_Oscilloscope_87	Line Voltage L2-L3 Sample #87	Float [32b-LSW]	R		44825
V_L23_Oscilloscope_88	Line Voltage L2-L3 Sample #88	Float [32b-LSW]	R		44827
V_L23_Oscilloscope_89	Line Voltage L2-L3 Sample #89	Float [32b-LSW]	R		44829
V_L23_Oscilloscope_90	Line Voltage L2-L3 Sample #90	Float [32b-LSW]	R		44831
V_L23_Oscilloscope_91	Line Voltage L2-L3 Sample #91	Float [32b-LSW]	R		44833
V_L23_Oscilloscope_92	Line Voltage L2-L3 Sample #92	Float [32b-LSW]	R		44835
V_L23_Oscilloscope_93	Line Voltage L2-L3 Sample #93	Float [32b-LSW]	R		44837
V_L23_Oscilloscope_94	Line Voltage L2-L3 Sample #94	Float [32b-LSW]	R		44839
V_L23_Oscilloscope_95	Line Voltage L2-L3 Sample #95	Float [32b-LSW]	R		44841
V_L23_Oscilloscope_96	Line Voltage L2-L3 Sample #96	Float [32b-LSW]	R		44843
V_L23_Oscilloscope_97	Line Voltage L2-L3 Sample #97	Float [32b-LSW]	R		44845
V_L23_Oscilloscope_98	Line Voltage L2-L3 Sample #98	Float [32b-LSW]	R		44847
V_L23_Oscilloscope_99	Line Voltage L2-L3 Sample #99	Float [32b-LSW]	R		44849
V_L23_Oscilloscope_100	Line Voltage L2-L3 Sample #100	Float [32b-LSW]	R		44851
V_L23_Oscilloscope_101	Line Voltage L2-L3 Sample #101	Float [32b-LSW]	R		44853
V_L23_Oscilloscope_102	Line Voltage L2-L3 Sample #102	Float [32b-LSW]	R		44855
V_L23_Oscilloscope_103	Line Voltage L2-L3 Sample #103	Float [32b-LSW]	R		44857
V_L23_Oscilloscope_104	Line Voltage L2-L3 Sample #104	Float [32b-LSW]	R		44859
V_L23_Oscilloscope_105	Line Voltage L2-L3 Sample #105	Float [32b-LSW]	R		44861
V_L23_Oscilloscope_106	Line Voltage L2-L3 Sample #106	Float [32b-LSW]	R		44863
V_L23_Oscilloscope_107	Line Voltage L2-L3 Sample #107	Float [32b-LSW]	R		44865
V_L23_Oscilloscope_108	Line Voltage L2-L3 Sample #108	Float [32b-LSW]	R		44867



Register Name	Description	Register Type	R/W	Default	Address Modbus
V_L23_Oscilloscope_109	Line Voltage L2-L3 Sample #109	Float [32b-LSW]	R		44869
V_L23_Oscilloscope_110	Line Voltage L2-L3 Sample #110	Float [32b-LSW]	R		44871
V_L23_Oscilloscope_111	Line Voltage L2-L3 Sample #111	Float [32b-LSW]	R		44873
V_L23_Oscilloscope_112	Line Voltage L2-L3 Sample #112	Float [32b-LSW]	R		44875
V_L23_Oscilloscope_113	Line Voltage L2-L3 Sample #113	Float [32b-LSW]	R		44877
V_L23_Oscilloscope_114	Line Voltage L2-L3 Sample #114	Float [32b-LSW]	R		44879
V_L23_Oscilloscope_115	Line Voltage L2-L3 Sample #115	Float [32b-LSW]	R		44881
V_L23_Oscilloscope_116	Line Voltage L2-L3 Sample #116	Float [32b-LSW]	R		44883
V_L23_Oscilloscope_117	Line Voltage L2-L3 Sample #117	Float [32b-LSW]	R		44885
V_L23_Oscilloscope_118	Line Voltage L2-L3 Sample #118	Float [32b-LSW]	R		44887
V_L23_Oscilloscope_119	Line Voltage L2-L3 Sample #119	Float [32b-LSW]	R		44889
V_L23_Oscilloscope_120	Line Voltage L2-L3 Sample #120	Float [32b-LSW]	R		44891
V_L23_Oscilloscope_121	Line Voltage L2-L3 Sample #121	Float [32b-LSW]	R		44893
V_L23_Oscilloscope_122	Line Voltage L2-L3 Sample #122	Float [32b-LSW]	R		44895
V_L23_Oscilloscope_123	Line Voltage L2-L3 Sample #123	Float [32b-LSW]	R		44897
V_L23_Oscilloscope_124	Line Voltage L2-L3 Sample #124	Float [32b-LSW]	R		44899
V_L23_Oscilloscope_125	Line Voltage L2-L3 Sample #125	Float [32b-LSW]	R		44901
V_L23_Oscilloscope_126	Line Voltage L2-L3 Sample #126	Float [32b-LSW]	R		44903
V_L23_Oscilloscope_127	Line Voltage L2-L3 Sample #127	Float [32b-LSW]	R		44905
V_L31_Oscilloscope_0	Line Voltage L3-L1 Sample #0	Float [32b-LSW]	R		44907
V_L31_Oscilloscope_1	Line Voltage L3-L1 Sample #1	Float [32b-LSW]	R		44909
V_L31_Oscilloscope_2	Line Voltage L3-L1 Sample #2	Float [32b-LSW]	R		44911
V_L31_Oscilloscope_3	Line Voltage L3-L1 Sample #3	Float [32b-LSW]	R		44913
V_L31_Oscilloscope_4	Line Voltage L3-L1 Sample #4	Float [32b-LSW]	R		44915
V_L31_Oscilloscope_5	Line Voltage L3-L1 Sample #5	Float [32b-LSW]	R		44917
V_L31_Oscilloscope_6	Line Voltage L3-L1 Sample #6	Float [32b-LSW]	R		44919
V_L31_Oscilloscope_7	Line Voltage L3-L1 Sample #7	Float [32b-LSW]	R		44921
V_L31_Oscilloscope_8	Line Voltage L3-L1 Sample #8	Float [32b-LSW]	R		44923
V_L31_Oscilloscope_9	Line Voltage L3-L1 Sample #9	Float [32b-LSW]	R		44925
V_L31_Oscilloscope_10	Line Voltage L3-L1 Sample #10	Float [32b-LSW]	R		44927
V_L31_Oscilloscope_11	Line Voltage L3-L1 Sample #11	Float [32b-LSW]	R		44929
V_L31_Oscilloscope_12	Line Voltage L3-L1 Sample #12	Float [32b-LSW]	R		44931
V_L31_Oscilloscope_13	Line Voltage L3-L1 Sample #13	Float [32b-LSW]	R		44933
V_L31_Oscilloscope_14	Line Voltage L3-L1 Sample #14	Float [32b-LSW]	R		44935
V_L31_Oscilloscope_15	Line Voltage L3-L1 Sample #15	Float [32b-LSW]	R		44937
V_L31_Oscilloscope_16	Line Voltage L3-L1 Sample #16	Float [32b-LSW]	R		44939
V_L31_Oscilloscope_17	Line Voltage L3-L1 Sample #17	Float [32b-LSW]	R		44941
V_L31_Oscilloscope_18	Line Voltage L3-L1 Sample #18	Float [32b-LSW]	R		44943
V_L31_Oscilloscope_19	Line Voltage L3-L1 Sample #19	Float [32b-LSW]	R		44945
V_L31_Oscilloscope_20	Line Voltage L3-L1 Sample #20	Float [32b-LSW]	R		44947
V_L31_Oscilloscope_21	Line Voltage L3-L1 Sample #21	Float [32b-LSW]	R		44949
V_L31_Oscilloscope_22	Line Voltage L3-L1 Sample #22	Float [32b-LSW]	R		44951
V_L31_Oscilloscope_23	Line Voltage L3-L1 Sample #23	Float [32b-LSW]	R		44953
V_L31_Oscilloscope_24	Line Voltage L3-L1 Sample #24	Float [32b-LSW]	R		44955
V_L31_Oscilloscope_25	Line Voltage L3-L1 Sample #25	Float [32b-LSW]	R		44957
V_L31_Oscilloscope_26	Line Voltage L3-L1 Sample #26	Float [32b-LSW]	R		44959
V_L31_Oscilloscope_27	Line Voltage L3-L1 Sample #27	Float [32b-LSW]	R		44961
V_L31_Oscilloscope_28	Line Voltage L3-L1 Sample #28	Float [32b-LSW]	R		44963
V_L31_Oscilloscope_29	Line Voltage L3-L1 Sample #29	Float [32b-LSW]	R		44965
V_L31_Oscilloscope_30	Line Voltage L3-L1 Sample #30	Float [32b-LSW]	R		44967
V_L31_Oscilloscope_31	Line Voltage L3-L1 Sample #31	Float [32b-LSW]	R		44969
V_L31_Oscilloscope_32	Line Voltage L3-L1 Sample #32	Float [32b-LSW]	R		44971
V_L31_Oscilloscope_33	Line Voltage L3-L1 Sample #33	Float [32b-LSW]	R		44973
V_L31_Oscilloscope_34	Line Voltage L3-L1 Sample #34	Float [32b-LSW]	R		44975
V_L31_Oscilloscope_35	Line Voltage L3-L1 Sample #35	Float [32b-LSW]	R		44977
V_L31_Oscilloscope_36	Line Voltage L3-L1 Sample #36	Float [32b-LSW]	R		44979
V_L31_Oscilloscope_37	Line Voltage L3-L1 Sample #37	Float [32b-LSW]	R		44981
V_L31_Oscilloscope_38	Line Voltage L3-L1 Sample #38	Float [32b-LSW]	R		44983
V_L31_Oscilloscope_39	Line Voltage L3-L1 Sample #39	Float [32b-LSW]	R		44985
V_L31_Oscilloscope_40	Line Voltage L3-L1 Sample #40	Float [32b-LSW]	R		44987
V_L31_Oscilloscope_41	Line Voltage L3-L1 Sample #41	Float [32b-LSW]	R		44989
V_L31_Oscilloscope_42	Line Voltage L3-L1 Sample #42	Float [32b-LSW]	R		44991
V_L31_Oscilloscope_43	Line Voltage L3-L1 Sample #43	Float [32b-LSW]	R		44993



Register Name	Description	Register Type	R/W	Default	Address Modbus
V_L31_Oscilloscope_44	Line Voltage L3-L1 Sample #44	Float [32b-LSW]	R		44995
V_L31_Oscilloscope_45	Line Voltage L3-L1 Sample #45	Float [32b-LSW]	R		44997
V_L31_Oscilloscope_46	Line Voltage L3-L1 Sample #46	Float [32b-LSW]	R		44999
V_L31_Oscilloscope_47	Line Voltage L3-L1 Sample #47	Float [32b-LSW]	R		45001
V_L31_Oscilloscope_48	Line Voltage L3-L1 Sample #48	Float [32b-LSW]	R		45003
V_L31_Oscilloscope_49	Line Voltage L3-L1 Sample #49	Float [32b-LSW]	R		45005
V_L31_Oscilloscope_50	Line Voltage L3-L1 Sample #50	Float [32b-LSW]	R		45007
V_L31_Oscilloscope_51	Line Voltage L3-L1 Sample #51	Float [32b-LSW]	R		45009
V_L31_Oscilloscope_52	Line Voltage L3-L1 Sample #52	Float [32b-LSW]	R		45011
V_L31_Oscilloscope_53	Line Voltage L3-L1 Sample #53	Float [32b-LSW]	R		45013
V_L31_Oscilloscope_54	Line Voltage L3-L1 Sample #54	Float [32b-LSW]	R		45015
V_L31_Oscilloscope_55	Line Voltage L3-L1 Sample #55	Float [32b-LSW]	R		45017
V_L31_Oscilloscope_56	Line Voltage L3-L1 Sample #56	Float [32b-LSW]	R		45019
V_L31_Oscilloscope_57	Line Voltage L3-L1 Sample #57	Float [32b-LSW]	R		45021
V_L31_Oscilloscope_58	Line Voltage L3-L1 Sample #58	Float [32b-LSW]	R		45023
V_L31_Oscilloscope_59	Line Voltage L3-L1 Sample #59	Float [32b-LSW]	R		45025
V_L31_Oscilloscope_60	Line Voltage L3-L1 Sample #60	Float [32b-LSW]	R		45027
V_L31_Oscilloscope_61	Line Voltage L3-L1 Sample #61	Float [32b-LSW]	R		45029
V_L31_Oscilloscope_62	Line Voltage L3-L1 Sample #62	Float [32b-LSW]	R		45031
V_L31_Oscilloscope_63	Line Voltage L3-L1 Sample #63	Float [32b-LSW]	R		45033
V_L31_Oscilloscope_64	Line Voltage L3-L1 Sample #64	Float [32b-LSW]	R		45035
V_L31_Oscilloscope_65	Line Voltage L3-L1 Sample #65	Float [32b-LSW]	R		45037
V_L31_Oscilloscope_66	Line Voltage L3-L1 Sample #66	Float [32b-LSW]	R		45039
V_L31_Oscilloscope_67	Line Voltage L3-L1 Sample #67	Float [32b-LSW]	R		45041
V_L31_Oscilloscope_68	Line Voltage L3-L1 Sample #68	Float [32b-LSW]	R		45043
V_L31_Oscilloscope_69	Line Voltage L3-L1 Sample #69	Float [32b-LSW]	R		45045
V_L31_Oscilloscope_70	Line Voltage L3-L1 Sample #70	Float [32b-LSW]	R		45047
V_L31_Oscilloscope_71	Line Voltage L3-L1 Sample #71	Float [32b-LSW]	R		45049
V_L31_Oscilloscope_72	Line Voltage L3-L1 Sample #72	Float [32b-LSW]	R		45051
V_L31_Oscilloscope_73	Line Voltage L3-L1 Sample #73	Float [32b-LSW]	R		45053
V_L31_Oscilloscope_74	Line Voltage L3-L1 Sample #74	Float [32b-LSW]	R		45055
V_L31_Oscilloscope_75	Line Voltage L3-L1 Sample #75	Float [32b-LSW]	R		45057
V_L31_Oscilloscope_76	Line Voltage L3-L1 Sample #76	Float [32b-LSW]	R		45059
V_L31_Oscilloscope_77	Line Voltage L3-L1 Sample #77	Float [32b-LSW]	R		45061
V_L31_Oscilloscope_78	Line Voltage L3-L1 Sample #78	Float [32b-LSW]	R		45063
V_L31_Oscilloscope_79	Line Voltage L3-L1 Sample #79	Float [32b-LSW]	R		45065
V_L31_Oscilloscope_80	Line Voltage L3-L1 Sample #80	Float [32b-LSW]	R		45067
V_L31_Oscilloscope_81	Line Voltage L3-L1 Sample #81	Float [32b-LSW]	R		45069
V_L31_Oscilloscope_82	Line Voltage L3-L1 Sample #82	Float [32b-LSW]	R		45071
V_L31_Oscilloscope_83	Line Voltage L3-L1 Sample #83	Float [32b-LSW]	R		45073
V_L31_Oscilloscope_84	Line Voltage L3-L1 Sample #84	Float [32b-LSW]	R		45075
V_L31_Oscilloscope_85	Line Voltage L3-L1 Sample #85	Float [32b-LSW]	R		45077
V_L31_Oscilloscope_86	Line Voltage L3-L1 Sample #86	Float [32b-LSW]	R		45079
V_L31_Oscilloscope_87	Line Voltage L3-L1 Sample #87	Float [32b-LSW]	R		45081
V_L31_Oscilloscope_88	Line Voltage L3-L1 Sample #88	Float [32b-LSW]	R		45083
V_L31_Oscilloscope_89	Line Voltage L3-L1 Sample #89	Float [32b-LSW]	R		45085
V_L31_Oscilloscope_90	Line Voltage L3-L1 Sample #90	Float [32b-LSW]	R		45087
V_L31_Oscilloscope_91	Line Voltage L3-L1 Sample #91	Float [32b-LSW]	R		45089
V_L31_Oscilloscope_92	Line Voltage L3-L1 Sample #92	Float [32b-LSW]	R		45091
V_L31_Oscilloscope_93	Line Voltage L3-L1 Sample #93	Float [32b-LSW]	R		45093
V_L31_Oscilloscope_94	Line Voltage L3-L1 Sample #94	Float [32b-LSW]	R		45095
V_L31_Oscilloscope_95	Line Voltage L3-L1 Sample #95	Float [32b-LSW]	R		45097
V_L31_Oscilloscope_96	Line Voltage L3-L1 Sample #96	Float [32b-LSW]	R		45099
V_L31_Oscilloscope_97	Line Voltage L3-L1 Sample #97	Float [32b-LSW]	R		45101
V_L31_Oscilloscope_98	Line Voltage L3-L1 Sample #98	Float [32b-LSW]	R		45103
V_L31_Oscilloscope_99	Line Voltage L3-L1 Sample #99	Float [32b-LSW]	R		45105
V_L31_Oscilloscope_100	Line Voltage L3-L1 Sample #100	Float [32b-LSW]	R		45107
V_L31_Oscilloscope_101	Line Voltage L3-L1 Sample #101	Float [32b-LSW]	R		45109
V_L31_Oscilloscope_102	Line Voltage L3-L1 Sample #102	Float [32b-LSW]	R		45111
V_L31_Oscilloscope_103	Line Voltage L3-L1 Sample #103	Float [32b-LSW]	R		45113
V_L31_Oscilloscope_104	Line Voltage L3-L1 Sample #104	Float [32b-LSW]	R		45115
V_L31_Oscilloscope_105	Line Voltage L3-L1 Sample #105	Float [32b-LSW]	R		45117
V_L31_Oscilloscope_106	Line Voltage L3-L1 Sample #106	Float [32b-LSW]	R		45119



Register Name	Description	Register Type	R/W	Default	Address Modbus
V_L31_Oscilloscope_107	Line Voltage L3-L1 Sample #107	Float [32b-LSW]	R		45121
V_L31_Oscilloscope_108	Line Voltage L3-L1 Sample #108	Float [32b-LSW]	R		45123
V_L31_Oscilloscope_109	Line Voltage L3-L1 Sample #109	Float [32b-LSW]	R		45125
V_L31_Oscilloscope_110	Line Voltage L3-L1 Sample #110	Float [32b-LSW]	R		45127
V_L31_Oscilloscope_111	Line Voltage L3-L1 Sample #111	Float [32b-LSW]	R		45129
V_L31_Oscilloscope_112	Line Voltage L3-L1 Sample #112	Float [32b-LSW]	R		45131
V_L31_Oscilloscope_113	Line Voltage L3-L1 Sample #113	Float [32b-LSW]	R		45133
V_L31_Oscilloscope_114	Line Voltage L3-L1 Sample #114	Float [32b-LSW]	R		45135
V_L31_Oscilloscope_115	Line Voltage L3-L1 Sample #115	Float [32b-LSW]	R		45137
V_L31_Oscilloscope_116	Line Voltage L3-L1 Sample #116	Float [32b-LSW]	R		45139
V_L31_Oscilloscope_117	Line Voltage L3-L1 Sample #117	Float [32b-LSW]	R		45141
V_L31_Oscilloscope_118	Line Voltage L3-L1 Sample #118	Float [32b-LSW]	R		45143
V_L31_Oscilloscope_119	Line Voltage L3-L1 Sample #119	Float [32b-LSW]	R		45145
V_L31_Oscilloscope_120	Line Voltage L3-L1 Sample #120	Float [32b-LSW]	R		45147
V_L31_Oscilloscope_121	Line Voltage L3-L1 Sample #121	Float [32b-LSW]	R		45149
V_L31_Oscilloscope_122	Line Voltage L3-L1 Sample #122	Float [32b-LSW]	R		45151
V_L31_Oscilloscope_123	Line Voltage L3-L1 Sample #123	Float [32b-LSW]	R		45153
V_L31_Oscilloscope_124	Line Voltage L3-L1 Sample #124	Float [32b-LSW]	R		45155
V_L31_Oscilloscope_125	Line Voltage L3-L1 Sample #125	Float [32b-LSW]	R		45157
V_L31_Oscilloscope_126	Line Voltage L3-L1 Sample #126	Float [32b-LSW]	R		45159
V_L31_Oscilloscope_127	Line Voltage L3-L1 Sample #127	Float [32b-LSW]	R		45161
I_L1_Oscilloscope_0	Line Current L1 Sample #0	Float [32b-LSW]	R		45163
I_L1_Oscilloscope_1	Line Current L1 Sample #1	Float [32b-LSW]	R		45165
I_L1_Oscilloscope_2	Line Current L1 Sample #2	Float [32b-LSW]	R		45167
I_L1_Oscilloscope_3	Line Current L1 Sample #3	Float [32b-LSW]	R		45169
I_L1_Oscilloscope_4	Line Current L1 Sample #4	Float [32b-LSW]	R		45171
I_L1_Oscilloscope_5	Line Current L1 Sample #5	Float [32b-LSW]	R		45173
I_L1_Oscilloscope_6	Line Current L1 Sample #6	Float [32b-LSW]	R		45175
I_L1_Oscilloscope_7	Line Current L1 Sample #7	Float [32b-LSW]	R		45177
I_L1_Oscilloscope_8	Line Current L1 Sample #8	Float [32b-LSW]	R		45179
I_L1_Oscilloscope_9	Line Current L1 Sample #9	Float [32b-LSW]	R		45181
I_L1_Oscilloscope_10	Line Current L1 Sample #10	Float [32b-LSW]	R		45183
I_L1_Oscilloscope_11	Line Current L1 Sample #11	Float [32b-LSW]	R		45185
I_L1_Oscilloscope_12	Line Current L1 Sample #12	Float [32b-LSW]	R		45187
I_L1_Oscilloscope_13	Line Current L1 Sample #13	Float [32b-LSW]	R		45189
I_L1_Oscilloscope_14	Line Current L1 Sample #14	Float [32b-LSW]	R		45191
I_L1_Oscilloscope_15	Line Current L1 Sample #15	Float [32b-LSW]	R		45193
I_L1_Oscilloscope_16	Line Current L1 Sample #16	Float [32b-LSW]	R		45195
I_L1_Oscilloscope_17	Line Current L1 Sample #17	Float [32b-LSW]	R		45197
I_L1_Oscilloscope_18	Line Current L1 Sample #18	Float [32b-LSW]	R		45199
I_L1_Oscilloscope_19	Line Current L1 Sample #19	Float [32b-LSW]	R		45201
I_L1_Oscilloscope_20	Line Current L1 Sample #20	Float [32b-LSW]	R		45203
I_L1_Oscilloscope_21	Line Current L1 Sample #21	Float [32b-LSW]	R		45205
I_L1_Oscilloscope_22	Line Current L1 Sample #22	Float [32b-LSW]	R		45207
I_L1_Oscilloscope_23	Line Current L1 Sample #23	Float [32b-LSW]	R		45209
I_L1_Oscilloscope_24	Line Current L1 Sample #24	Float [32b-LSW]	R		45211
I_L1_Oscilloscope_25	Line Current L1 Sample #25	Float [32b-LSW]	R		45213
I_L1_Oscilloscope_26	Line Current L1 Sample #26	Float [32b-LSW]	R		45215
I_L1_Oscilloscope_27	Line Current L1 Sample #27	Float [32b-LSW]	R		45217
I_L1_Oscilloscope_28	Line Current L1 Sample #28	Float [32b-LSW]	R		45219
I_L1_Oscilloscope_29	Line Current L1 Sample #29	Float [32b-LSW]	R		45221
I_L1_Oscilloscope_30	Line Current L1 Sample #30	Float [32b-LSW]	R		45223
I_L1_Oscilloscope_31	Line Current L1 Sample #31	Float [32b-LSW]	R		45225
I_L1_Oscilloscope_32	Line Current L1 Sample #32	Float [32b-LSW]	R		45227
I_L1_Oscilloscope_33	Line Current L1 Sample #33	Float [32b-LSW]	R		45229
I_L1_Oscilloscope_34	Line Current L1 Sample #34	Float [32b-LSW]	R		45231
I_L1_Oscilloscope_35	Line Current L1 Sample #35	Float [32b-LSW]	R		45233
I_L1_Oscilloscope_36	Line Current L1 Sample #36	Float [32b-LSW]	R		45235
I_L1_Oscilloscope_37	Line Current L1 Sample #37	Float [32b-LSW]	R		45237
I_L1_Oscilloscope_38	Line Current L1 Sample #38	Float [32b-LSW]	R		45239
I_L1_Oscilloscope_39	Line Current L1 Sample #39	Float [32b-LSW]	R		45241
I_L1_Oscilloscope_40	Line Current L1 Sample #40	Float [32b-LSW]	R		45243
I_L1_Oscilloscope_41	Line Current L1 Sample #41	Float [32b-LSW]	R		45245



Register Name	Description	Register Type	R/W	Default	Address Modbus
I_L1_Oscilloscope_42	Line Current L1 Sample #42	Float [32b-LSW]	R		45247
I_L1_Oscilloscope_43	Line Current L1 Sample #43	Float [32b-LSW]	R		45249
I_L1_Oscilloscope_44	Line Current L1 Sample #44	Float [32b-LSW]	R		45251
I_L1_Oscilloscope_45	Line Current L1 Sample #45	Float [32b-LSW]	R		45253
I_L1_Oscilloscope_46	Line Current L1 Sample #46	Float [32b-LSW]	R		45255
I_L1_Oscilloscope_47	Line Current L1 Sample #47	Float [32b-LSW]	R		45257
I_L1_Oscilloscope_48	Line Current L1 Sample #48	Float [32b-LSW]	R		45259
I_L1_Oscilloscope_49	Line Current L1 Sample #49	Float [32b-LSW]	R		45261
I_L1_Oscilloscope_50	Line Current L1 Sample #50	Float [32b-LSW]	R		45263
I_L1_Oscilloscope_51	Line Current L1 Sample #51	Float [32b-LSW]	R		45265
I_L1_Oscilloscope_52	Line Current L1 Sample #52	Float [32b-LSW]	R		45267
I_L1_Oscilloscope_53	Line Current L1 Sample #53	Float [32b-LSW]	R		45269
I_L1_Oscilloscope_54	Line Current L1 Sample #54	Float [32b-LSW]	R		45271
I_L1_Oscilloscope_55	Line Current L1 Sample #55	Float [32b-LSW]	R		45273
I_L1_Oscilloscope_56	Line Current L1 Sample #56	Float [32b-LSW]	R		45275
I_L1_Oscilloscope_57	Line Current L1 Sample #57	Float [32b-LSW]	R		45277
I_L1_Oscilloscope_58	Line Current L1 Sample #58	Float [32b-LSW]	R		45279
I_L1_Oscilloscope_59	Line Current L1 Sample #59	Float [32b-LSW]	R		45281
I_L1_Oscilloscope_60	Line Current L1 Sample #60	Float [32b-LSW]	R		45283
I_L1_Oscilloscope_61	Line Current L1 Sample #61	Float [32b-LSW]	R		45285
I_L1_Oscilloscope_62	Line Current L1 Sample #62	Float [32b-LSW]	R		45287
I_L1_Oscilloscope_63	Line Current L1 Sample #63	Float [32b-LSW]	R		45289
I_L1_Oscilloscope_64	Line Current L1 Sample #64	Float [32b-LSW]	R		45291
I_L1_Oscilloscope_65	Line Current L1 Sample #65	Float [32b-LSW]	R		45293
I_L1_Oscilloscope_66	Line Current L1 Sample #66	Float [32b-LSW]	R		45295
I_L1_Oscilloscope_67	Line Current L1 Sample #67	Float [32b-LSW]	R		45297
I_L1_Oscilloscope_68	Line Current L1 Sample #68	Float [32b-LSW]	R		45299
I_L1_Oscilloscope_69	Line Current L1 Sample #69	Float [32b-LSW]	R		45301
I_L1_Oscilloscope_70	Line Current L1 Sample #70	Float [32b-LSW]	R		45303
I_L1_Oscilloscope_71	Line Current L1 Sample #71	Float [32b-LSW]	R		45305
I_L1_Oscilloscope_72	Line Current L1 Sample #72	Float [32b-LSW]	R		45307
I_L1_Oscilloscope_73	Line Current L1 Sample #73	Float [32b-LSW]	R		45309
I_L1_Oscilloscope_74	Line Current L1 Sample #74	Float [32b-LSW]	R		45311
I_L1_Oscilloscope_75	Line Current L1 Sample #75	Float [32b-LSW]	R		45313
I_L1_Oscilloscope_76	Line Current L1 Sample #76	Float [32b-LSW]	R		45315
I_L1_Oscilloscope_77	Line Current L1 Sample #77	Float [32b-LSW]	R		45317
I_L1_Oscilloscope_78	Line Current L1 Sample #78	Float [32b-LSW]	R		45319
I_L1_Oscilloscope_79	Line Current L1 Sample #79	Float [32b-LSW]	R		45321
I_L1_Oscilloscope_80	Line Current L1 Sample #80	Float [32b-LSW]	R		45323
I_L1_Oscilloscope_81	Line Current L1 Sample #81	Float [32b-LSW]	R		45325
I_L1_Oscilloscope_82	Line Current L1 Sample #82	Float [32b-LSW]	R		45327
I_L1_Oscilloscope_83	Line Current L1 Sample #83	Float [32b-LSW]	R		45329
I_L1_Oscilloscope_84	Line Current L1 Sample #84	Float [32b-LSW]	R		45331
I_L1_Oscilloscope_85	Line Current L1 Sample #85	Float [32b-LSW]	R		45333
I_L1_Oscilloscope_86	Line Current L1 Sample #86	Float [32b-LSW]	R		45335
I_L1_Oscilloscope_87	Line Current L1 Sample #87	Float [32b-LSW]	R		45337
I_L1_Oscilloscope_88	Line Current L1 Sample #88	Float [32b-LSW]	R		45339
I_L1_Oscilloscope_89	Line Current L1 Sample #89	Float [32b-LSW]	R		45341
I_L1_Oscilloscope_90	Line Current L1 Sample #90	Float [32b-LSW]	R		45343
I_L1_Oscilloscope_91	Line Current L1 Sample #91	Float [32b-LSW]	R		45345
I_L1_Oscilloscope_92	Line Current L1 Sample #92	Float [32b-LSW]	R		45347
I_L1_Oscilloscope_93	Line Current L1 Sample #93	Float [32b-LSW]	R		45349
I_L1_Oscilloscope_94	Line Current L1 Sample #94	Float [32b-LSW]	R		45351
I_L1_Oscilloscope_95	Line Current L1 Sample #95	Float [32b-LSW]	R		45353
I_L1_Oscilloscope_96	Line Current L1 Sample #96	Float [32b-LSW]	R		45355
I_L1_Oscilloscope_97	Line Current L1 Sample #97	Float [32b-LSW]	R		45357
I_L1_Oscilloscope_98	Line Current L1 Sample #98	Float [32b-LSW]	R		45359
I_L1_Oscilloscope_99	Line Current L1 Sample #99	Float [32b-LSW]	R		45361
I_L1_Oscilloscope_100	Line Current L1 Sample #100	Float [32b-LSW]	R		45363
I_L1_Oscilloscope_101	Line Current L1 Sample #101	Float [32b-LSW]	R		45365
I_L1_Oscilloscope_102	Line Current L1 Sample #102	Float [32b-LSW]	R		45367
I_L1_Oscilloscope_103	Line Current L1 Sample #103	Float [32b-LSW]	R		45369
I_L1_Oscilloscope_104	Line Current L1 Sample #104	Float [32b-LSW]	R		45371



Register Name	Description	Register Type	R/W	Default	Address Modbus
I_L1_Oscilloscope_105	Line Current L1 Sample #105	Float [32b-LSW]	R		45373
I_L1_Oscilloscope_106	Line Current L1 Sample #106	Float [32b-LSW]	R		45375
I_L1_Oscilloscope_107	Line Current L1 Sample #107	Float [32b-LSW]	R		45377
I_L1_Oscilloscope_108	Line Current L1 Sample #108	Float [32b-LSW]	R		45379
I_L1_Oscilloscope_109	Line Current L1 Sample #109	Float [32b-LSW]	R		45381
I_L1_Oscilloscope_110	Line Current L1 Sample #110	Float [32b-LSW]	R		45383
I_L1_Oscilloscope_111	Line Current L1 Sample #111	Float [32b-LSW]	R		45385
I_L1_Oscilloscope_112	Line Current L1 Sample #112	Float [32b-LSW]	R		45387
I_L1_Oscilloscope_113	Line Current L1 Sample #113	Float [32b-LSW]	R		45389
I_L1_Oscilloscope_114	Line Current L1 Sample #114	Float [32b-LSW]	R		45391
I_L1_Oscilloscope_115	Line Current L1 Sample #115	Float [32b-LSW]	R		45393
I_L1_Oscilloscope_116	Line Current L1 Sample #116	Float [32b-LSW]	R		45395
I_L1_Oscilloscope_117	Line Current L1 Sample #117	Float [32b-LSW]	R		45397
I_L1_Oscilloscope_118	Line Current L1 Sample #118	Float [32b-LSW]	R		45399
I_L1_Oscilloscope_119	Line Current L1 Sample #119	Float [32b-LSW]	R		45401
I_L1_Oscilloscope_120	Line Current L1 Sample #120	Float [32b-LSW]	R		45403
I_L1_Oscilloscope_121	Line Current L1 Sample #121	Float [32b-LSW]	R		45405
I_L1_Oscilloscope_122	Line Current L1 Sample #122	Float [32b-LSW]	R		45407
I_L1_Oscilloscope_123	Line Current L1 Sample #123	Float [32b-LSW]	R		45409
I_L1_Oscilloscope_124	Line Current L1 Sample #124	Float [32b-LSW]	R		45411
I_L1_Oscilloscope_125	Line Current L1 Sample #125	Float [32b-LSW]	R		45413
I_L1_Oscilloscope_126	Line Current L1 Sample #126	Float [32b-LSW]	R		45415
I_L1_Oscilloscope_127	Line Current L1 Sample #127	Float [32b-LSW]	R		45417
I_L2_Oscilloscope_0	Line Current L2 Sample #0	Float [32b-LSW]	R		45419
I_L2_Oscilloscope_1	Line Current L2 Sample #1	Float [32b-LSW]	R		45421
I_L2_Oscilloscope_2	Line Current L2 Sample #2	Float [32b-LSW]	R		45423
I_L2_Oscilloscope_3	Line Current L2 Sample #3	Float [32b-LSW]	R		45425
I_L2_Oscilloscope_4	Line Current L2 Sample #4	Float [32b-LSW]	R		45427
I_L2_Oscilloscope_5	Line Current L2 Sample #5	Float [32b-LSW]	R		45429
I_L2_Oscilloscope_6	Line Current L2 Sample #6	Float [32b-LSW]	R		45431
I_L2_Oscilloscope_7	Line Current L2 Sample #7	Float [32b-LSW]	R		45433
I_L2_Oscilloscope_8	Line Current L2 Sample #8	Float [32b-LSW]	R		45435
I_L2_Oscilloscope_9	Line Current L2 Sample #9	Float [32b-LSW]	R		45437
I_L2_Oscilloscope_10	Line Current L2 Sample #10	Float [32b-LSW]	R		45439
I_L2_Oscilloscope_11	Line Current L2 Sample #11	Float [32b-LSW]	R		45441
I_L2_Oscilloscope_12	Line Current L2 Sample #12	Float [32b-LSW]	R		45443
I_L2_Oscilloscope_13	Line Current L2 Sample #13	Float [32b-LSW]	R		45445
I_L2_Oscilloscope_14	Line Current L2 Sample #14	Float [32b-LSW]	R		45447
I_L2_Oscilloscope_15	Line Current L2 Sample #15	Float [32b-LSW]	R		45449
I_L2_Oscilloscope_16	Line Current L2 Sample #16	Float [32b-LSW]	R		45451
I_L2_Oscilloscope_17	Line Current L2 Sample #17	Float [32b-LSW]	R		45453
I_L2_Oscilloscope_18	Line Current L2 Sample #18	Float [32b-LSW]	R		45455
I_L2_Oscilloscope_19	Line Current L2 Sample #19	Float [32b-LSW]	R		45457
I_L2_Oscilloscope_20	Line Current L2 Sample #20	Float [32b-LSW]	R		45459
I_L2_Oscilloscope_21	Line Current L2 Sample #21	Float [32b-LSW]	R		45461
I_L2_Oscilloscope_22	Line Current L2 Sample #22	Float [32b-LSW]	R		45463
I_L2_Oscilloscope_23	Line Current L2 Sample #23	Float [32b-LSW]	R		45465
I_L2_Oscilloscope_24	Line Current L2 Sample #24	Float [32b-LSW]	R		45467
I_L2_Oscilloscope_25	Line Current L2 Sample #25	Float [32b-LSW]	R		45469
I_L2_Oscilloscope_26	Line Current L2 Sample #26	Float [32b-LSW]	R		45471
I_L2_Oscilloscope_27	Line Current L2 Sample #27	Float [32b-LSW]	R		45473
I_L2_Oscilloscope_28	Line Current L2 Sample #28	Float [32b-LSW]	R		45475
I_L2_Oscilloscope_29	Line Current L2 Sample #29	Float [32b-LSW]	R		45477
I_L2_Oscilloscope_30	Line Current L2 Sample #30	Float [32b-LSW]	R		45479
I_L2_Oscilloscope_31	Line Current L2 Sample #31	Float [32b-LSW]	R		45481
I_L2_Oscilloscope_32	Line Current L2 Sample #32	Float [32b-LSW]	R		45483
I_L2_Oscilloscope_33	Line Current L2 Sample #33	Float [32b-LSW]	R		45485
I_L2_Oscilloscope_34	Line Current L2 Sample #34	Float [32b-LSW]	R		45487
I_L2_Oscilloscope_35	Line Current L2 Sample #35	Float [32b-LSW]	R		45489
I_L2_Oscilloscope_36	Line Current L2 Sample #36	Float [32b-LSW]	R		45491
I_L2_Oscilloscope_37	Line Current L2 Sample #37	Float [32b-LSW]	R		45493
I_L2_Oscilloscope_38	Line Current L2 Sample #38	Float [32b-LSW]	R		45495
I_L2_Oscilloscope_39	Line Current L2 Sample #39	Float [32b-LSW]	R		45497



Register Name	Description	Register Type	R/W	Default	Address Modbus
I_L2_Oscilloscope_40	Line Current L2 Sample #40	Float [32b-LSW]	R		45499
I_L2_Oscilloscope_41	Line Current L2 Sample #41	Float [32b-LSW]	R		45501
I_L2_Oscilloscope_42	Line Current L2 Sample #42	Float [32b-LSW]	R		45503
I_L2_Oscilloscope_43	Line Current L2 Sample #43	Float [32b-LSW]	R		45505
I_L2_Oscilloscope_44	Line Current L2 Sample #44	Float [32b-LSW]	R		45507
I_L2_Oscilloscope_45	Line Current L2 Sample #45	Float [32b-LSW]	R		45509
I_L2_Oscilloscope_46	Line Current L2 Sample #46	Float [32b-LSW]	R		45511
I_L2_Oscilloscope_47	Line Current L2 Sample #47	Float [32b-LSW]	R		45513
I_L2_Oscilloscope_48	Line Current L2 Sample #48	Float [32b-LSW]	R		45515
I_L2_Oscilloscope_49	Line Current L2 Sample #49	Float [32b-LSW]	R		45517
I_L2_Oscilloscope_50	Line Current L2 Sample #50	Float [32b-LSW]	R		45519
I_L2_Oscilloscope_51	Line Current L2 Sample #51	Float [32b-LSW]	R		45521
I_L2_Oscilloscope_52	Line Current L2 Sample #52	Float [32b-LSW]	R		45523
I_L2_Oscilloscope_53	Line Current L2 Sample #53	Float [32b-LSW]	R		45525
I_L2_Oscilloscope_54	Line Current L2 Sample #54	Float [32b-LSW]	R		45527
I_L2_Oscilloscope_55	Line Current L2 Sample #55	Float [32b-LSW]	R		45529
I_L2_Oscilloscope_56	Line Current L2 Sample #56	Float [32b-LSW]	R		45531
I_L2_Oscilloscope_57	Line Current L2 Sample #57	Float [32b-LSW]	R		45533
I_L2_Oscilloscope_58	Line Current L2 Sample #58	Float [32b-LSW]	R		45535
I_L2_Oscilloscope_59	Line Current L2 Sample #59	Float [32b-LSW]	R		45537
I_L2_Oscilloscope_60	Line Current L2 Sample #60	Float [32b-LSW]	R		45539
I_L2_Oscilloscope_61	Line Current L2 Sample #61	Float [32b-LSW]	R		45541
I_L2_Oscilloscope_62	Line Current L2 Sample #62	Float [32b-LSW]	R		45543
I_L2_Oscilloscope_63	Line Current L2 Sample #63	Float [32b-LSW]	R		45545
I_L2_Oscilloscope_64	Line Current L2 Sample #64	Float [32b-LSW]	R		45547
I_L2_Oscilloscope_65	Line Current L2 Sample #65	Float [32b-LSW]	R		45549
I_L2_Oscilloscope_66	Line Current L2 Sample #66	Float [32b-LSW]	R		45551
I_L2_Oscilloscope_67	Line Current L2 Sample #67	Float [32b-LSW]	R		45553
I_L2_Oscilloscope_68	Line Current L2 Sample #68	Float [32b-LSW]	R		45555
I_L2_Oscilloscope_69	Line Current L2 Sample #69	Float [32b-LSW]	R		45557
I_L2_Oscilloscope_70	Line Current L2 Sample #70	Float [32b-LSW]	R		45559
I_L2_Oscilloscope_71	Line Current L2 Sample #71	Float [32b-LSW]	R		45561
I_L2_Oscilloscope_72	Line Current L2 Sample #72	Float [32b-LSW]	R		45563
I_L2_Oscilloscope_73	Line Current L2 Sample #73	Float [32b-LSW]	R		45565
I_L2_Oscilloscope_74	Line Current L2 Sample #74	Float [32b-LSW]	R		45567
I_L2_Oscilloscope_75	Line Current L2 Sample #75	Float [32b-LSW]	R		45569
I_L2_Oscilloscope_76	Line Current L2 Sample #76	Float [32b-LSW]	R		45571
I_L2_Oscilloscope_77	Line Current L2 Sample #77	Float [32b-LSW]	R		45573
I_L2_Oscilloscope_78	Line Current L2 Sample #78	Float [32b-LSW]	R		45575
I_L2_Oscilloscope_79	Line Current L2 Sample #79	Float [32b-LSW]	R		45577
I_L2_Oscilloscope_80	Line Current L2 Sample #80	Float [32b-LSW]	R		45579
I_L2_Oscilloscope_81	Line Current L2 Sample #81	Float [32b-LSW]	R		45581
I_L2_Oscilloscope_82	Line Current L2 Sample #82	Float [32b-LSW]	R		45583
I_L2_Oscilloscope_83	Line Current L2 Sample #83	Float [32b-LSW]	R		45585
I_L2_Oscilloscope_84	Line Current L2 Sample #84	Float [32b-LSW]	R		45587
I_L2_Oscilloscope_85	Line Current L2 Sample #85	Float [32b-LSW]	R		45589
I_L2_Oscilloscope_86	Line Current L2 Sample #86	Float [32b-LSW]	R		45591
I_L2_Oscilloscope_87	Line Current L2 Sample #87	Float [32b-LSW]	R		45593
I_L2_Oscilloscope_88	Line Current L2 Sample #88	Float [32b-LSW]	R		45595
I_L2_Oscilloscope_89	Line Current L2 Sample #89	Float [32b-LSW]	R		45597
I_L2_Oscilloscope_90	Line Current L2 Sample #90	Float [32b-LSW]	R		45599
I_L2_Oscilloscope_91	Line Current L2 Sample #91	Float [32b-LSW]	R		45601
I_L2_Oscilloscope_92	Line Current L2 Sample #92	Float [32b-LSW]	R		45603
I_L2_Oscilloscope_93	Line Current L2 Sample #93	Float [32b-LSW]	R		45605
I_L2_Oscilloscope_94	Line Current L2 Sample #94	Float [32b-LSW]	R		45607
I_L2_Oscilloscope_95	Line Current L2 Sample #95	Float [32b-LSW]	R		45609
I_L2_Oscilloscope_96	Line Current L2 Sample #96	Float [32b-LSW]	R		45611
I_L2_Oscilloscope_97	Line Current L2 Sample #97	Float [32b-LSW]	R		45613
I_L2_Oscilloscope_98	Line Current L2 Sample #98	Float [32b-LSW]	R		45615
I_L2_Oscilloscope_99	Line Current L2 Sample #99	Float [32b-LSW]	R		45617
I_L2_Oscilloscope_100	Line Current L2 Sample #100	Float [32b-LSW]	R		45619
I_L2_Oscilloscope_101	Line Current L2 Sample #101	Float [32b-LSW]	R		45621
I_L2_Oscilloscope_102	Line Current L2 Sample #102	Float [32b-LSW]	R		45623



Register Name	Description	Register Type	R/W	Default	Address Modbus
I_L2_Oscilloscope_103	Line Current L2 Sample #103	Float [32b-LSW]	R		45625
I_L2_Oscilloscope_104	Line Current L2 Sample #104	Float [32b-LSW]	R		45627
I_L2_Oscilloscope_105	Line Current L2 Sample #105	Float [32b-LSW]	R		45629
I_L2_Oscilloscope_106	Line Current L2 Sample #106	Float [32b-LSW]	R		45631
I_L2_Oscilloscope_107	Line Current L2 Sample #107	Float [32b-LSW]	R		45633
I_L2_Oscilloscope_108	Line Current L2 Sample #108	Float [32b-LSW]	R		45635
I_L2_Oscilloscope_109	Line Current L2 Sample #109	Float [32b-LSW]	R		45637
I_L2_Oscilloscope_110	Line Current L2 Sample #110	Float [32b-LSW]	R		45639
I_L2_Oscilloscope_111	Line Current L2 Sample #111	Float [32b-LSW]	R		45641
I_L2_Oscilloscope_112	Line Current L2 Sample #112	Float [32b-LSW]	R		45643
I_L2_Oscilloscope_113	Line Current L2 Sample #113	Float [32b-LSW]	R		45645
I_L2_Oscilloscope_114	Line Current L2 Sample #114	Float [32b-LSW]	R		45647
I_L2_Oscilloscope_115	Line Current L2 Sample #115	Float [32b-LSW]	R		45649
I_L2_Oscilloscope_116	Line Current L2 Sample #116	Float [32b-LSW]	R		45651
I_L2_Oscilloscope_117	Line Current L2 Sample #117	Float [32b-LSW]	R		45653
I_L2_Oscilloscope_118	Line Current L2 Sample #118	Float [32b-LSW]	R		45655
I_L2_Oscilloscope_119	Line Current L2 Sample #119	Float [32b-LSW]	R		45657
I_L2_Oscilloscope_120	Line Current L2 Sample #120	Float [32b-LSW]	R		45659
I_L2_Oscilloscope_121	Line Current L2 Sample #121	Float [32b-LSW]	R		45661
I_L2_Oscilloscope_122	Line Current L2 Sample #122	Float [32b-LSW]	R		45663
I_L2_Oscilloscope_123	Line Current L2 Sample #123	Float [32b-LSW]	R		45665
I_L2_Oscilloscope_124	Line Current L2 Sample #124	Float [32b-LSW]	R		45667
I_L2_Oscilloscope_125	Line Current L2 Sample #125	Float [32b-LSW]	R		45669
I_L2_Oscilloscope_126	Line Current L2 Sample #126	Float [32b-LSW]	R		45671
I_L2_Oscilloscope_127	Line Current L2 Sample #127	Float [32b-LSW]	R		45673
I_L3_Oscilloscope_0	Line Current L3 Sample #0	Float [32b-LSW]	R		45675
I_L3_Oscilloscope_1	Line Current L3 Sample #1	Float [32b-LSW]	R		45677
I_L3_Oscilloscope_2	Line Current L3 Sample #2	Float [32b-LSW]	R		45679
I_L3_Oscilloscope_3	Line Current L3 Sample #3	Float [32b-LSW]	R		45681
I_L3_Oscilloscope_4	Line Current L3 Sample #4	Float [32b-LSW]	R		45683
I_L3_Oscilloscope_5	Line Current L3 Sample #5	Float [32b-LSW]	R		45685
I_L3_Oscilloscope_6	Line Current L3 Sample #6	Float [32b-LSW]	R		45687
I_L3_Oscilloscope_7	Line Current L3 Sample #7	Float [32b-LSW]	R		45689
I_L3_Oscilloscope_8	Line Current L3 Sample #8	Float [32b-LSW]	R		45691
I_L3_Oscilloscope_9	Line Current L3 Sample #9	Float [32b-LSW]	R		45693
I_L3_Oscilloscope_10	Line Current L3 Sample #10	Float [32b-LSW]	R		45695
I_L3_Oscilloscope_11	Line Current L3 Sample #11	Float [32b-LSW]	R		45697
I_L3_Oscilloscope_12	Line Current L3 Sample #12	Float [32b-LSW]	R		45699
I_L3_Oscilloscope_13	Line Current L3 Sample #13	Float [32b-LSW]	R		45701
I_L3_Oscilloscope_14	Line Current L3 Sample #14	Float [32b-LSW]	R		45703
I_L3_Oscilloscope_15	Line Current L3 Sample #15	Float [32b-LSW]	R		45705
I_L3_Oscilloscope_16	Line Current L3 Sample #16	Float [32b-LSW]	R		45707
I_L3_Oscilloscope_17	Line Current L3 Sample #17	Float [32b-LSW]	R		45709
I_L3_Oscilloscope_18	Line Current L3 Sample #18	Float [32b-LSW]	R		45711
I_L3_Oscilloscope_19	Line Current L3 Sample #19	Float [32b-LSW]	R		45713
I_L3_Oscilloscope_20	Line Current L3 Sample #20	Float [32b-LSW]	R		45715
I_L3_Oscilloscope_21	Line Current L3 Sample #21	Float [32b-LSW]	R		45717
I_L3_Oscilloscope_22	Line Current L3 Sample #22	Float [32b-LSW]	R		45719
I_L3_Oscilloscope_23	Line Current L3 Sample #23	Float [32b-LSW]	R		45721
I_L3_Oscilloscope_24	Line Current L3 Sample #24	Float [32b-LSW]	R		45723
I_L3_Oscilloscope_25	Line Current L3 Sample #25	Float [32b-LSW]	R		45725
I_L3_Oscilloscope_26	Line Current L3 Sample #26	Float [32b-LSW]	R		45727
I_L3_Oscilloscope_27	Line Current L3 Sample #27	Float [32b-LSW]	R		45729
I_L3_Oscilloscope_28	Line Current L3 Sample #28	Float [32b-LSW]	R		45731
I_L3_Oscilloscope_29	Line Current L3 Sample #29	Float [32b-LSW]	R		45733
I_L3_Oscilloscope_30	Line Current L3 Sample #30	Float [32b-LSW]	R		45735
I_L3_Oscilloscope_31	Line Current L3 Sample #31	Float [32b-LSW]	R		45737
I_L3_Oscilloscope_32	Line Current L3 Sample #32	Float [32b-LSW]	R		45739
I_L3_Oscilloscope_33	Line Current L3 Sample #33	Float [32b-LSW]	R		45741
I_L3_Oscilloscope_34	Line Current L3 Sample #34	Float [32b-LSW]	R		45743
I_L3_Oscilloscope_35	Line Current L3 Sample #35	Float [32b-LSW]	R		45745
I_L3_Oscilloscope_36	Line Current L3 Sample #36	Float [32b-LSW]	R		45747
I_L3_Oscilloscope_37	Line Current L3 Sample #37	Float [32b-LSW]	R		45749



Register Name	Description	Register Type	R/W	Default	Address Modbus
I_L3_Oscilloscope_38	Line Current L3 Sample #38	Float [32b-LSW]	R		45751
I_L3_Oscilloscope_39	Line Current L3 Sample #39	Float [32b-LSW]	R		45753
I_L3_Oscilloscope_40	Line Current L3 Sample #40	Float [32b-LSW]	R		45755
I_L3_Oscilloscope_41	Line Current L3 Sample #41	Float [32b-LSW]	R		45757
I_L3_Oscilloscope_42	Line Current L3 Sample #42	Float [32b-LSW]	R		45759
I_L3_Oscilloscope_43	Line Current L3 Sample #43	Float [32b-LSW]	R		45761
I_L3_Oscilloscope_44	Line Current L3 Sample #44	Float [32b-LSW]	R		45763
I_L3_Oscilloscope_45	Line Current L3 Sample #45	Float [32b-LSW]	R		45765
I_L3_Oscilloscope_46	Line Current L3 Sample #46	Float [32b-LSW]	R		45767
I_L3_Oscilloscope_47	Line Current L3 Sample #47	Float [32b-LSW]	R		45769
I_L3_Oscilloscope_48	Line Current L3 Sample #48	Float [32b-LSW]	R		45771
I_L3_Oscilloscope_49	Line Current L3 Sample #49	Float [32b-LSW]	R		45773
I_L3_Oscilloscope_50	Line Current L3 Sample #50	Float [32b-LSW]	R		45775
I_L3_Oscilloscope_51	Line Current L3 Sample #51	Float [32b-LSW]	R		45777
I_L3_Oscilloscope_52	Line Current L3 Sample #52	Float [32b-LSW]	R		45779
I_L3_Oscilloscope_53	Line Current L3 Sample #53	Float [32b-LSW]	R		45781
I_L3_Oscilloscope_54	Line Current L3 Sample #54	Float [32b-LSW]	R		45783
I_L3_Oscilloscope_55	Line Current L3 Sample #55	Float [32b-LSW]	R		45785
I_L3_Oscilloscope_56	Line Current L3 Sample #56	Float [32b-LSW]	R		45787
I_L3_Oscilloscope_57	Line Current L3 Sample #57	Float [32b-LSW]	R		45789
I_L3_Oscilloscope_58	Line Current L3 Sample #58	Float [32b-LSW]	R		45791
I_L3_Oscilloscope_59	Line Current L3 Sample #59	Float [32b-LSW]	R		45793
I_L3_Oscilloscope_60	Line Current L3 Sample #60	Float [32b-LSW]	R		45795
I_L3_Oscilloscope_61	Line Current L3 Sample #61	Float [32b-LSW]	R		45797
I_L3_Oscilloscope_62	Line Current L3 Sample #62	Float [32b-LSW]	R		45799
I_L3_Oscilloscope_63	Line Current L3 Sample #63	Float [32b-LSW]	R		45801
I_L3_Oscilloscope_64	Line Current L3 Sample #64	Float [32b-LSW]	R		45803
I_L3_Oscilloscope_65	Line Current L3 Sample #65	Float [32b-LSW]	R		45805
I_L3_Oscilloscope_66	Line Current L3 Sample #66	Float [32b-LSW]	R		45807
I_L3_Oscilloscope_67	Line Current L3 Sample #67	Float [32b-LSW]	R		45809
I_L3_Oscilloscope_68	Line Current L3 Sample #68	Float [32b-LSW]	R		45811
I_L3_Oscilloscope_69	Line Current L3 Sample #69	Float [32b-LSW]	R		45813
I_L3_Oscilloscope_70	Line Current L3 Sample #70	Float [32b-LSW]	R		45815
I_L3_Oscilloscope_71	Line Current L3 Sample #71	Float [32b-LSW]	R		45817
I_L3_Oscilloscope_72	Line Current L3 Sample #72	Float [32b-LSW]	R		45819
I_L3_Oscilloscope_73	Line Current L3 Sample #73	Float [32b-LSW]	R		45821
I_L3_Oscilloscope_74	Line Current L3 Sample #74	Float [32b-LSW]	R		45823
I_L3_Oscilloscope_75	Line Current L3 Sample #75	Float [32b-LSW]	R		45825
I_L3_Oscilloscope_76	Line Current L3 Sample #76	Float [32b-LSW]	R		45827
I_L3_Oscilloscope_77	Line Current L3 Sample #77	Float [32b-LSW]	R		45829
I_L3_Oscilloscope_78	Line Current L3 Sample #78	Float [32b-LSW]	R		45831
I_L3_Oscilloscope_79	Line Current L3 Sample #79	Float [32b-LSW]	R		45833
I_L3_Oscilloscope_80	Line Current L3 Sample #80	Float [32b-LSW]	R		45835
I_L3_Oscilloscope_81	Line Current L3 Sample #81	Float [32b-LSW]	R		45837
I_L3_Oscilloscope_82	Line Current L3 Sample #82	Float [32b-LSW]	R		45839
I_L3_Oscilloscope_83	Line Current L3 Sample #83	Float [32b-LSW]	R		45841
I_L3_Oscilloscope_84	Line Current L3 Sample #84	Float [32b-LSW]	R		45843
I_L3_Oscilloscope_85	Line Current L3 Sample #85	Float [32b-LSW]	R		45845
I_L3_Oscilloscope_86	Line Current L3 Sample #86	Float [32b-LSW]	R		45847
I_L3_Oscilloscope_87	Line Current L3 Sample #87	Float [32b-LSW]	R		45849
I_L3_Oscilloscope_88	Line Current L3 Sample #88	Float [32b-LSW]	R		45851
I_L3_Oscilloscope_89	Line Current L3 Sample #89	Float [32b-LSW]	R		45853
I_L3_Oscilloscope_90	Line Current L3 Sample #90	Float [32b-LSW]	R		45855
I_L3_Oscilloscope_91	Line Current L3 Sample #91	Float [32b-LSW]	R		45857
I_L3_Oscilloscope_92	Line Current L3 Sample #92	Float [32b-LSW]	R		45859
I_L3_Oscilloscope_93	Line Current L3 Sample #93	Float [32b-LSW]	R		45861
I_L3_Oscilloscope_94	Line Current L3 Sample #94	Float [32b-LSW]	R		45863
I_L3_Oscilloscope_95	Line Current L3 Sample #95	Float [32b-LSW]	R		45865
I_L3_Oscilloscope_96	Line Current L3 Sample #96	Float [32b-LSW]	R		45867
I_L3_Oscilloscope_97	Line Current L3 Sample #97	Float [32b-LSW]	R		45869
I_L3_Oscilloscope_98	Line Current L3 Sample #98	Float [32b-LSW]	R		45871
I_L3_Oscilloscope_99	Line Current L3 Sample #99	Float [32b-LSW]	R		45873
I_L3_Oscilloscope_100	Line Current L3 Sample #100	Float [32b-LSW]	R		45875



Register Name	Description	Register Type	R/W	Default	Address Modbus
I_L3_Oscilloscope_101	Line Current L3 Sample #101	Float [32b-LSW]	R		45877
I_L3_Oscilloscope_102	Line Current L3 Sample #102	Float [32b-LSW]	R		45879
I_L3_Oscilloscope_103	Line Current L3 Sample #103	Float [32b-LSW]	R		45881
I_L3_Oscilloscope_104	Line Current L3 Sample #104	Float [32b-LSW]	R		45883
I_L3_Oscilloscope_105	Line Current L3 Sample #105	Float [32b-LSW]	R		45885
I_L3_Oscilloscope_106	Line Current L3 Sample #106	Float [32b-LSW]	R		45887
I_L3_Oscilloscope_107	Line Current L3 Sample #107	Float [32b-LSW]	R		45889
I_L3_Oscilloscope_108	Line Current L3 Sample #108	Float [32b-LSW]	R		45891
I_L3_Oscilloscope_109	Line Current L3 Sample #109	Float [32b-LSW]	R		45893
I_L3_Oscilloscope_110	Line Current L3 Sample #110	Float [32b-LSW]	R		45895
I_L3_Oscilloscope_111	Line Current L3 Sample #111	Float [32b-LSW]	R		45897
I_L3_Oscilloscope_112	Line Current L3 Sample #112	Float [32b-LSW]	R		45899
I_L3_Oscilloscope_113	Line Current L3 Sample #113	Float [32b-LSW]	R		45901
I_L3_Oscilloscope_114	Line Current L3 Sample #114	Float [32b-LSW]	R		45903
I_L3_Oscilloscope_115	Line Current L3 Sample #115	Float [32b-LSW]	R		45905
I_L3_Oscilloscope_116	Line Current L3 Sample #116	Float [32b-LSW]	R		45907
I_L3_Oscilloscope_117	Line Current L3 Sample #117	Float [32b-LSW]	R		45909
I_L3_Oscilloscope_118	Line Current L3 Sample #118	Float [32b-LSW]	R		45911
I_L3_Oscilloscope_119	Line Current L3 Sample #119	Float [32b-LSW]	R		45913
I_L3_Oscilloscope_120	Line Current L3 Sample #120	Float [32b-LSW]	R		45915
I_L3_Oscilloscope_121	Line Current L3 Sample #121	Float [32b-LSW]	R		45917
I_L3_Oscilloscope_122	Line Current L3 Sample #122	Float [32b-LSW]	R		45919
I_L3_Oscilloscope_123	Line Current L3 Sample #123	Float [32b-LSW]	R		45921
I_L3_Oscilloscope_124	Line Current L3 Sample #124	Float [32b-LSW]	R		45923
I_L3_Oscilloscope_125	Line Current L3 Sample #125	Float [32b-LSW]	R		45925
I_L3_Oscilloscope_126	Line Current L3 Sample #126	Float [32b-LSW]	R		45927
I_L3_Oscilloscope_127	Line Current L3 Sample #127	Float [32b-LSW]	R		45929
I_N_Oscilloscope_0	Line Current N Sample #0	Float [32b-LSW]	R		45931
I_N_Oscilloscope_1	Line Current N Sample #1	Float [32b-LSW]	R		45933
I_N_Oscilloscope_2	Line Current N Sample #2	Float [32b-LSW]	R		45935
I_N_Oscilloscope_3	Line Current N Sample #3	Float [32b-LSW]	R		45937
I_N_Oscilloscope_4	Line Current N Sample #4	Float [32b-LSW]	R		45939
I_N_Oscilloscope_5	Line Current N Sample #5	Float [32b-LSW]	R		45941
I_N_Oscilloscope_6	Line Current N Sample #6	Float [32b-LSW]	R		45943
I_N_Oscilloscope_7	Line Current N Sample #7	Float [32b-LSW]	R		45945
I_N_Oscilloscope_8	Line Current N Sample #8	Float [32b-LSW]	R		45947
I_N_Oscilloscope_9	Line Current N Sample #9	Float [32b-LSW]	R		45949
I_N_Oscilloscope_10	Line Current N Sample #10	Float [32b-LSW]	R		45951
I_N_Oscilloscope_11	Line Current N Sample #11	Float [32b-LSW]	R		45953
I_N_Oscilloscope_12	Line Current N Sample #12	Float [32b-LSW]	R		45955
I_N_Oscilloscope_13	Line Current N Sample #13	Float [32b-LSW]	R		45957
I_N_Oscilloscope_14	Line Current N Sample #14	Float [32b-LSW]	R		45959
I_N_Oscilloscope_15	Line Current N Sample #15	Float [32b-LSW]	R		45961
I_N_Oscilloscope_16	Line Current N Sample #16	Float [32b-LSW]	R		45963
I_N_Oscilloscope_17	Line Current N Sample #17	Float [32b-LSW]	R		45965
I_N_Oscilloscope_18	Line Current N Sample #18	Float [32b-LSW]	R		45967
I_N_Oscilloscope_19	Line Current N Sample #19	Float [32b-LSW]	R		45969
I_N_Oscilloscope_20	Line Current N Sample #20	Float [32b-LSW]	R		45971
I_N_Oscilloscope_21	Line Current N Sample #21	Float [32b-LSW]	R		45973
I_N_Oscilloscope_22	Line Current N Sample #22	Float [32b-LSW]	R		45975
I_N_Oscilloscope_23	Line Current N Sample #23	Float [32b-LSW]	R		45977
I_N_Oscilloscope_24	Line Current N Sample #24	Float [32b-LSW]	R		45979
I_N_Oscilloscope_25	Line Current N Sample #25	Float [32b-LSW]	R		45981
I_N_Oscilloscope_26	Line Current N Sample #26	Float [32b-LSW]	R		45983
I_N_Oscilloscope_27	Line Current N Sample #27	Float [32b-LSW]	R		45985
I_N_Oscilloscope_28	Line Current N Sample #28	Float [32b-LSW]	R		45987
I_N_Oscilloscope_29	Line Current N Sample #29	Float [32b-LSW]	R		45989
I_N_Oscilloscope_30	Line Current N Sample #30	Float [32b-LSW]	R		45991
I_N_Oscilloscope_31	Line Current N Sample #31	Float [32b-LSW]	R		45993
I_N_Oscilloscope_32	Line Current N Sample #32	Float [32b-LSW]	R		45995
I_N_Oscilloscope_33	Line Current N Sample #33	Float [32b-LSW]	R		45997
I_N_Oscilloscope_34	Line Current N Sample #34	Float [32b-LSW]	R		45999
I_N_Oscilloscope_35	Line Current N Sample #35	Float [32b-LSW]	R		46001



Register Name	Description	Register Type	R/W	Default	Address Modbus
I_N_Oscilloscope_36	Line Current N Sample #36	Float [32b-LSW]	R		46003
I_N_Oscilloscope_37	Line Current N Sample #37	Float [32b-LSW]	R		46005
I_N_Oscilloscope_38	Line Current N Sample #38	Float [32b-LSW]	R		46007
I_N_Oscilloscope_39	Line Current N Sample #39	Float [32b-LSW]	R		46009
I_N_Oscilloscope_40	Line Current N Sample #40	Float [32b-LSW]	R		46011
I_N_Oscilloscope_41	Line Current N Sample #41	Float [32b-LSW]	R		46013
I_N_Oscilloscope_42	Line Current N Sample #42	Float [32b-LSW]	R		46015
I_N_Oscilloscope_43	Line Current N Sample #43	Float [32b-LSW]	R		46017
I_N_Oscilloscope_44	Line Current N Sample #44	Float [32b-LSW]	R		46019
I_N_Oscilloscope_45	Line Current N Sample #45	Float [32b-LSW]	R		46021
I_N_Oscilloscope_46	Line Current N Sample #46	Float [32b-LSW]	R		46023
I_N_Oscilloscope_47	Line Current N Sample #47	Float [32b-LSW]	R		46025
I_N_Oscilloscope_48	Line Current N Sample #48	Float [32b-LSW]	R		46027
I_N_Oscilloscope_49	Line Current N Sample #49	Float [32b-LSW]	R		46029
I_N_Oscilloscope_50	Line Current N Sample #50	Float [32b-LSW]	R		46031
I_N_Oscilloscope_51	Line Current N Sample #51	Float [32b-LSW]	R		46033
I_N_Oscilloscope_52	Line Current N Sample #52	Float [32b-LSW]	R		46035
I_N_Oscilloscope_53	Line Current N Sample #53	Float [32b-LSW]	R		46037
I_N_Oscilloscope_54	Line Current N Sample #54	Float [32b-LSW]	R		46039
I_N_Oscilloscope_55	Line Current N Sample #55	Float [32b-LSW]	R		46041
I_N_Oscilloscope_56	Line Current N Sample #56	Float [32b-LSW]	R		46043
I_N_Oscilloscope_57	Line Current N Sample #57	Float [32b-LSW]	R		46045
I_N_Oscilloscope_58	Line Current N Sample #58	Float [32b-LSW]	R		46047
I_N_Oscilloscope_59	Line Current N Sample #59	Float [32b-LSW]	R		46049
I_N_Oscilloscope_60	Line Current N Sample #60	Float [32b-LSW]	R		46051
I_N_Oscilloscope_61	Line Current N Sample #61	Float [32b-LSW]	R		46053
I_N_Oscilloscope_62	Line Current N Sample #62	Float [32b-LSW]	R		46055
I_N_Oscilloscope_63	Line Current N Sample #63	Float [32b-LSW]	R		46057
I_N_Oscilloscope_64	Line Current N Sample #64	Float [32b-LSW]	R		46059
I_N_Oscilloscope_65	Line Current N Sample #65	Float [32b-LSW]	R		46061
I_N_Oscilloscope_66	Line Current N Sample #66	Float [32b-LSW]	R		46063
I_N_Oscilloscope_67	Line Current N Sample #67	Float [32b-LSW]	R		46065
I_N_Oscilloscope_68	Line Current N Sample #68	Float [32b-LSW]	R		46067
I_N_Oscilloscope_69	Line Current N Sample #69	Float [32b-LSW]	R		46069
I_N_Oscilloscope_70	Line Current N Sample #70	Float [32b-LSW]	R		46071
I_N_Oscilloscope_71	Line Current N Sample #71	Float [32b-LSW]	R		46073
I_N_Oscilloscope_72	Line Current N Sample #72	Float [32b-LSW]	R		46075
I_N_Oscilloscope_73	Line Current N Sample #73	Float [32b-LSW]	R		46077
I_N_Oscilloscope_74	Line Current N Sample #74	Float [32b-LSW]	R		46079
I_N_Oscilloscope_75	Line Current N Sample #75	Float [32b-LSW]	R		46081
I_N_Oscilloscope_76	Line Current N Sample #76	Float [32b-LSW]	R		46083
I_N_Oscilloscope_77	Line Current N Sample #77	Float [32b-LSW]	R		46085
I_N_Oscilloscope_78	Line Current N Sample #78	Float [32b-LSW]	R		46087
I_N_Oscilloscope_79	Line Current N Sample #79	Float [32b-LSW]	R		46089
I_N_Oscilloscope_80	Line Current N Sample #80	Float [32b-LSW]	R		46091
I_N_Oscilloscope_81	Line Current N Sample #81	Float [32b-LSW]	R		46093
I_N_Oscilloscope_82	Line Current N Sample #82	Float [32b-LSW]	R		46095
I_N_Oscilloscope_83	Line Current N Sample #83	Float [32b-LSW]	R		46097
I_N_Oscilloscope_84	Line Current N Sample #84	Float [32b-LSW]	R		46099
I_N_Oscilloscope_85	Line Current N Sample #85	Float [32b-LSW]	R		46101
I_N_Oscilloscope_86	Line Current N Sample #86	Float [32b-LSW]	R		46103
I_N_Oscilloscope_87	Line Current N Sample #87	Float [32b-LSW]	R		46105
I_N_Oscilloscope_88	Line Current N Sample #88	Float [32b-LSW]	R		46107
I_N_Oscilloscope_89	Line Current N Sample #89	Float [32b-LSW]	R		46109
I_N_Oscilloscope_90	Line Current N Sample #90	Float [32b-LSW]	R		46111
I_N_Oscilloscope_91	Line Current N Sample #91	Float [32b-LSW]	R		46113
I_N_Oscilloscope_92	Line Current N Sample #92	Float [32b-LSW]	R		46115
I_N_Oscilloscope_93	Line Current N Sample #93	Float [32b-LSW]	R		46117
I_N_Oscilloscope_94	Line Current N Sample #94	Float [32b-LSW]	R		46119
I_N_Oscilloscope_95	Line Current N Sample #95	Float [32b-LSW]	R		46121
I_N_Oscilloscope_96	Line Current N Sample #96	Float [32b-LSW]	R		46123
I_N_Oscilloscope_97	Line Current N Sample #97	Float [32b-LSW]	R		46125
I_N_Oscilloscope_98	Line Current N Sample #98	Float [32b-LSW]	R		46127



Register Name	Description	Register Type	R/W	Default	Address Modbus
I_N_Oscilloscope_99	Line Current N Sample #99	Float [32b-LSW]	R		46129
I_N_Oscilloscope_100	Line Current N Sample #100	Float [32b-LSW]	R		46131
I_N_Oscilloscope_101	Line Current N Sample #101	Float [32b-LSW]	R		46133
I_N_Oscilloscope_102	Line Current N Sample #102	Float [32b-LSW]	R		46135
I_N_Oscilloscope_103	Line Current N Sample #103	Float [32b-LSW]	R		46137
I_N_Oscilloscope_104	Line Current N Sample #104	Float [32b-LSW]	R		46139
I_N_Oscilloscope_105	Line Current N Sample #105	Float [32b-LSW]	R		46141
I_N_Oscilloscope_106	Line Current N Sample #106	Float [32b-LSW]	R		46143
I_N_Oscilloscope_107	Line Current N Sample #107	Float [32b-LSW]	R		46145
I_N_Oscilloscope_108	Line Current N Sample #108	Float [32b-LSW]	R		46147
I_N_Oscilloscope_109	Line Current N Sample #109	Float [32b-LSW]	R		46149
I_N_Oscilloscope_110	Line Current N Sample #110	Float [32b-LSW]	R		46151
I_N_Oscilloscope_111	Line Current N Sample #111	Float [32b-LSW]	R		46153
I_N_Oscilloscope_112	Line Current N Sample #112	Float [32b-LSW]	R		46155
I_N_Oscilloscope_113	Line Current N Sample #113	Float [32b-LSW]	R		46157
I_N_Oscilloscope_114	Line Current N Sample #114	Float [32b-LSW]	R		46159
I_N_Oscilloscope_115	Line Current N Sample #115	Float [32b-LSW]	R		46161
I_N_Oscilloscope_116	Line Current N Sample #116	Float [32b-LSW]	R		46163
I_N_Oscilloscope_117	Line Current N Sample #117	Float [32b-LSW]	R		46165
I_N_Oscilloscope_118	Line Current N Sample #118	Float [32b-LSW]	R		46167
I_N_Oscilloscope_119	Line Current N Sample #119	Float [32b-LSW]	R		46169
I_N_Oscilloscope_120	Line Current N Sample #120	Float [32b-LSW]	R		46171
I_N_Oscilloscope_121	Line Current N Sample #121	Float [32b-LSW]	R		46173
I_N_Oscilloscope_122	Line Current N Sample #122	Float [32b-LSW]	R		46175
I_N_Oscilloscope_123	Line Current N Sample #123	Float [32b-LSW]	R		46177
I_N_Oscilloscope_124	Line Current N Sample #124	Float [32b-LSW]	R		46179
I_N_Oscilloscope_125	Line Current N Sample #125	Float [32b-LSW]	R		46181
I_N_Oscilloscope_126	Line Current N Sample #126	Float [32b-LSW]	R		46183
I_N_Oscilloscope_127	Line Current N Sample #127	Float [32b-LSW]	R		46185

LEGEND:

Short [16b] = Signed Short (16 bit)
UShort [16b] = Unsigned Short (16 bit)

Long [32b-MSW] = Signed Long (32 bit - MSW First Register)
Long [32b-LWS] = Signed Long (32 bit - LSW First Register)
ULong [32b-LSW] = Unsigned Long (32 bit - LSW First Register)
ULong [32b] = Unsigned Long (32 bit)

Float [32b-MSW] = Float (32 bit - MSW First Register)
Float [32b-LSW] = Float (32 bit - LSW First Register)

UInt [16b] = Unsigned Integer (16 bit)
UInt [32b-MSW] = Unsigned Integer (32 bit - MSW First Register)
Int [64b-LSW] = Signed Long Long (64 bit - LSW First Register)